

RAIDER®



2023 - 2024



Марката Raider през годините

Уважаеми клиенти и партньори,

Пред вас е новият каталог на Raider 2020 год., където можете да намерите цялостни решения за Вашия бизнес сред богатия избор от акумулаторни, електрически, бензинови и пневматични машини и консумативи за тях. Този каталог включва 1630 артикули, от които 388 са нови.

Марката Raider е собствен бранд на Евромастер Импорт - Експорт ООД, познат и утвърден на българския пазар от двадесет години. Разнообразието на машини в този бранд, покрива практически целия диапазон дейности - строителство, дървообработване, металообработване, авто и градинска техника. Предлагаме и пълна гама съответни консумативи, съвместими не само с машините с бранд Raider. След успешния старт през 2000 година, марката Raider не е изменила на визията и мисията си, базирани на потребностите и очакванията на потребителите. Съобразно тях сме обновили асортимента си, достигайки по-високо технологично равнище.

Ценностите, на които се гради успехът ни са:

- Технологично качество, отговарящо на високи професионални изисквания, на разумна, достъпна и конкурентна цена;
- Качество, на което клиентите се доверяват;
- Стабилни, открити и честни взаимоотношения с бизнес партньори, производители и дистрибутори;
- Професионална и лична отговорност за поетите рискове и взетите решения.

С новите машини и усъвършенстването на моделите, спечелили Вашето доверие с доказаното си качество, ние добавяме допълнителни ползи и предимства и адаптираме продуктите към пазарната среда, за да продължава Raider да бъде най-доброто предложение при избор на машини за интензивна работа при професионални условия.

След утвърждаването на продуктите в България, Raider успешно разширява дистрибуторската си мрежа и пазарния си дял в редица страни от Централна и Източна Европа.

Raider Brand over the years

Dear Customers and Partners,

The trademark Raider celebrates its 20th birthday anniversary during this year.

Now you have our new Raider product catalogue, where you can find complete solutions for your business among the wide selection of electric, gasoline and pneumatic equipment and consumables. This catalog includes 1630 articles, of which 388 are new.

Raider brand is Euromaster Import - Export Ltd. own brand known and recognized on Bulgarian market for twenty years. The variety of instruments with this brand covers practically the whole range of activities - construction, woodworking, metalworking, auto- and garden equipment. The variety of machines with this brand covers practically the whole range of activities - construction, woodworking, metalworking, auto- and garden equipment. We offer also a full range of related accessories, compatible not only with Raider brand machines.

After the successful launch in 2000, Raider brand has not altered its vision and mission based on the needs and expectations of consumers; we have upgraded its range accordingly, reaching a higher level of technology. The values upon which our success was built are:

- Technological quality meeting the highest professional requirements at a reasonable, affordable and competitive price;
- Quality that customers trust;
- Stable, open and honest relationships with business partners, manufacturers and distributors;
- Professional and personal responsibility for the taken risks and decisions.

With the new machines and improvement of models, which earn your trust with proven quality, we add additional benefits and advantages and adapt our products to the market environment to keep being RAIDER best deal when choosing a machine for intensive use in a professional environment.

With the recognition of the products in Bulgaria, Raider has been successfully expanding its market share and developing its distribution network in several countries of Central and Eastern Europe.

ЕВРОМАСТЕР Импорт - Експорт ООД

Р. България, 1231 София,
бул. "Ломско шосе" 246
тел.: 0700 44 155 за цялата страна
e-mail: info@euromasterbg.com
www.euromasterbg.com

EUROMASTER Import Export Ltd.

Bulgaria, 1231 Sofia,
246 Lomsko Chaussee Blvd.
tel.: (00 359) 87 530 0101
e-mail: info@euromasterbg.com
www.euromasterbg.com

EUROMASTER SRL Romania

Str. Drumul Garii Otopeni,
Nr. 6, Otopeni, Ilfov
Tel.: +4 021 3510106
e-mail: info@euromasters.ro
www.euromasters.ro

"Евромастер Импорт - Експорт" ООД, информира, че авторските права на този каталог, включващи неговия текст, поместените фотографии, пиктограми, схеми, чертежи и дизайн, принадлежат изключително на "Евромастер Импорт - Експорт" ООД и подлежат на правна защита съгласно „Закона за авторското право и сродните му права“ влязъл в сила на 01.08.1993 г. и последните изменения публикувани в „Държавен вестник“ бр. 32 от 28 Април 2009 г.

Копирането, публикуването, модифицирането с комерсиална цел на каталога, както и на отделни елементи от него без съгласието на "Евромастер Импорт - Експорт" ООД, изразено в писмена форма, е строго забранено и може да доведе до подвеждане под отговорност.

All rights reserved. Euromaster Import - Export Ltd informs that the copyright of this catalog, including its text, photographs, pictograms, diagrams, drawings and designs belong exclusively to Euromaster Import - Export Ltd and are subject to legal protection.

Copying, publishing, modifying the catalog with commercial purposes, as well as individual elements thereof without the consent of Euromaster Import - Export Ltd expressed in written form is strictly prohibited and may result in liability.

www.raider.bg

RAIDER®

Pro

R20 System



**ONE BATTERY
FITS ALL**

CORDLESS DRILL RDP-SCD20

• [BG] Акумулаторна бормашина • [RO] Masina de gaurit si insurubat • [SR] Bušilica
• [MK] Батериска бормашина • [RU] Аккумуляторная дрель • [SL] Akumulatorski vrtalnik
vijačnik • [EL] Δραπανοκατσαβίδο • [HR] Akumulatorska bušilica • [FR] Perceuse sans fil • [IT]
Trapano senza cordone • [ES] Taladro inalámbrico sin batería y cargador • [PT] Aparafusadora

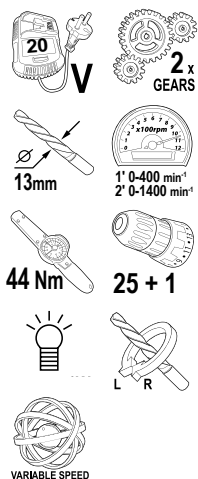

RDP-SCD20 SOLO

Art.No	gross weight	in cartoon	barcode
030130	1.500 kg	10 pcs	3800123168185

RDP-SCD20 WITH BATTERY 1.5Ah SET

Art.No	gross weight	in cartoon	barcode
030211	2.320 kg	10 pcs	3800972005372

CORDLESS DRILL RDP-SPCD20 SET

• [BG] Акумулаторна бормашина • [RO] Masina de gaurit si insurubat • [SR] Bušilica
• [MK] Батериска бормашина • [RU] Аккумуляторная дрель • [SL] Akumulatorski vrtalnik
vijačnik • [EL] Δραπανοκατσαβίδο • [HR] Akumulatorska bušilica • [FR] Perceuse sans fil • [IT]
Trapano senza cordone • [ES] Taladro inalámbrico sin batería y cargador • [PT] Aparafusadora

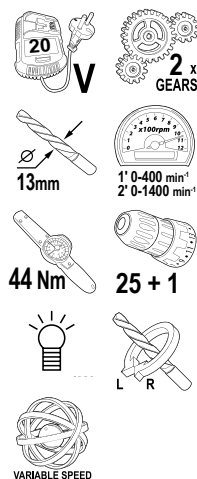

RDP-SPCD20 SET

Art.No	gross weight	in cartoon	barcode
030227	1.500 kg	10 pcs	3800972025516

RDP-SPCD20 SET

Art.No	gross weight	in cartoon	barcode
030228	1.500 kg	10 pcs	3800972025516

CORDLESS HAMMER DRILL - DRIVER RDP-SCDI20

• [BG] Бормашина ударна акумулаторна • [RO] Masina de gaurit si insurubat cu percutie • [SR]
Bušilica • [MK] Батериска бормашина • [RU] Аккумуляторная дрель • [SL] Akumulatorski vrtalnik
vijačnik • [EL] Δραπανοκατσαβίδο • [HR] Akumulatorska bušilica • [FR] Perceuse sans • [IT] Trapano
senza cordone • [ES] Taladro inalámbrico • [PT] Aparafusadora de percussão

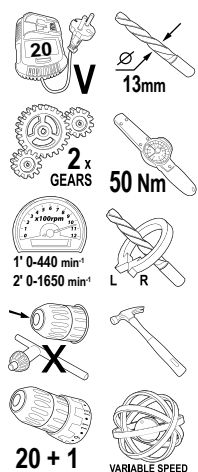

RDP-SCDI20 SOLO

Art.No	gross weight	in cartoon	barcode
030131	1.920 kg	5 pcs	3800123168277

RDP-SCDI20 WITH 2 BATTERIES 2Ah SET IN CASE

Art.No	gross weight	in cartoon	barcode
030208	4.250 kg	4 pcs	3800972005341

CORDLESS HAMMER DRILL RDP-SCDI20S

• [BG] Бормашина ударна акумулаторна • [RO] Masina de gaurit si insurubat cu percutie
• [SR] Bušilica • [MK] Батериска бормашина • [RU] Аккумуляторная дрель • [SL] Akumulatorski
vrtalnik vijačnik • [EL] Δραπανοκατσαβίδο • [HR] Akumulatorska bušilica • [FR] Perceuse sans
• [IT] Trapano senza cordone • [ES] Taladro inalámbrico • [PT] Aparafusadora de percussão

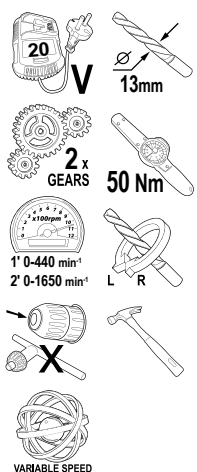

RDP-SCDI20S SOLO

Art.No	gross weight	barcode
030217	1.920 kg	3800972017160

RDP-SCDI20S WITH 2 BATTERIES 2Ah SET IN CASE

Art.No	gross weight	barcode
030216	4.250 kg	3800972017153

R20 BRUSHLESS CORDLESS DRILL 2 SPEED 10 MM 44 NM 2 AH IN CASE RDP-PBCD20 SET

• [BG] Акумулаторна бормашина безчеткова • [RO] Masina de gaurit si insurubat • [SR] Bušilica sa
akumulatorom • [MK] Батериска бормашина • [RU] Аккумуляторная дрель • [SL] Akumulatorski
vrtalnik vijačnik • [EL] Δραπανοκατσαβίδο • [HR] Akumulatorska bušilica • [FR] Perceuse sans
• [IT] Trapano senza cordone • [ES] Taladro inalámbrico • [PT] Aparafusadora de percussão

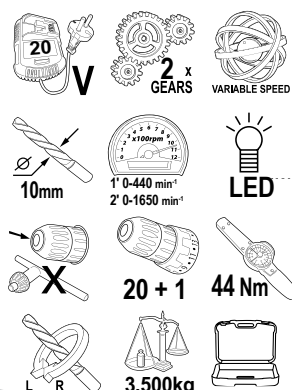

RDP-PBCD20 SET

Art.No	barcode
030231	3800972026858

BRUSHLESS CORDLESS DRAYWALL SCREWDRIVER SOLO RDP-SBES20

• [BG] Акумулаторен безчетков винтоверт за гипсокартон без батерия и зарядно
• [RO] Surubelnita • [SR] Odvijač • [MK] Батериска штрафилица • [RU] Аккумуляторная отвёртка
• [SL] Akumulatorski izvijač zavijake zagrips plošče • [EL] Κατσαβίδι για γυψοσανίδες
• [HR] Akumulatorski odvijač • [FR] Tournevis à cloisons sèches • [IT] Cacciavite per cartongesso
• [ES] Desegnilo drywall • [PT] Aparafusadora p/ gesso cartonado

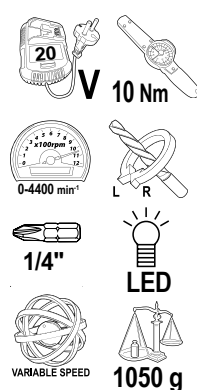

RDP-SBES20 SOLO

Art.No	gross weight	in cartoon	barcode
030159	1.170 kg	5	3800972018464

CORDLESS HEX IMPACT DRIVER SOLO RDP-SHID20

• [BG] Винтоверт ударен акумулаторен без батерия и зарядно • [RO] Surubelnita cu impact fără baterie și încărcător • [SR] Odvijač bez baterija i punjač • [MK] Батериска штрафилица без батерија и полнач [RU] Аккумуляторная шуруповерт без аккумулятора и зарядного устройства • [SL] Akumulatorski izvijač zavijake brez baterije in polnilnika • [EL] Δραπανοκατσαβίδο χωρίς μπαταρία και φορτιστή • [HR] Akumulatorska odvijač bez baterije i punjača • [FR] Perceuse sans fil sans batterie et chargeur • [IT] Trapano senza cordone senza batteria e caricabatterie • [ES] Taladro inalámbrico sin batería y cargador • [PT] Aparafusadora de impacto/caixa a bateria

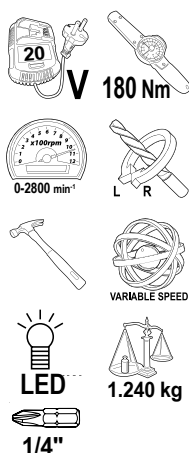
RDP-SHID20 SOLO

Art.No	gross weight	in cartoon	barcode
030132	1.580 kg	5 pcs	3800123168192

CORDLESS IMPACT WRENCH SOLO RDP-SCIW20

• [BG] Гайковерт ударен акумулаторен без батерия и зарядно • [RO] Masina de insurubat cu impact fără baterie și încărcător • [SR] Bušilica bez baterija i punjač • [MK] Батериска бормашина без батерија и полнач [RU] Гайковерт без аккумулятора и зарядного устройства • [SL] Akumulatorski vrtalnik vijasniki brez baterije in polnilnika • [EL] Δραπανοκατσαβίδο χωρίς μπαταρία και φορτιστή • [HR] Akumulatorska bušilica bez baterije i punjača • [FR] Perceuse sans fil sans batterie et chargeur • [IT] Trapano senza cordone senza batteria e caricabatterie • [ES] Taladro inalámbrico sin batería y cargador • [PT] Aparafusadora de impacto/caixa a bateria

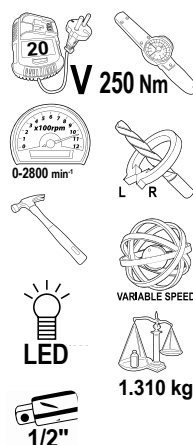
RDP-SCIW20 SOLO

Art.No	gross weight	in cartoon	barcode
030133	1.640 kg	5 pcs	3800123168215

CORDLESS IMPACT WRENCH SOLO RDP-SCIW20S

• [BG] Гайковерт ударен акумулаторен без батерия и зарядно • [RO] Masina de insurubat cu impact fără baterie și încărcător • [SR] Bušilica bez baterija i punjač • [MK] Батериска бормашина без батерија и полнач [RU] Гайковерт без аккумулятора и зарядного устройства • [SL] Akumulatorski vrtalnik vijasniki brez baterije in polnilnika • [EL] Δραπανοκατσαβίδο χωρίς μπαταρία και φορτιστή • [HR] Akumulatorska bušilica bez baterije i punjača • [FR] Perceuse sans fil sans batterie et chargeur • [IT] Trapano senza cordone senza batteria e caricabatterie • [ES] Taladro inalámbrico sin batería y cargador • [PT] Aparafusadora de impacto/caixa a bateria

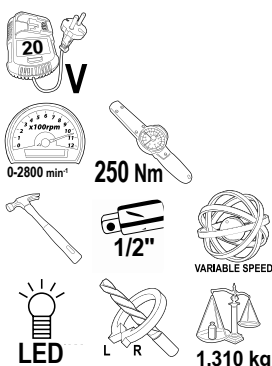
RDP-SCIW20S SOLO

Art.No	barcode
030221	3800972017207

CORDLESS IMPACT WRENCH SOLO RDP-SCIW20-5

• [BG] Гайковерт ударен акумулаторен без батерия и зарядно • [RO] Masina de insurubat cu impact fără baterie și încărcător • [SR] Bušilica bez baterija i punjač • [MK] Батериска бормашина без батерија и полнач [RU] Гайковерт без аккумулятора и зарядного устройства • [SL] Akumulatorski vrtalnik vijasniki brez baterije in polnilnika • [EL] Δραπανοκατσαβίδο χωρίς μπαταρία και φορτιστή • [HR] Akumulatorska bušilica bez baterije i punjača • [FR] Perceuse sans fil sans batterie et chargeur • [IT] Trapano senza cordone senza batteria e caricabatterie • [ES] Taladro inalámbrico sin batería y cargador • [PT] Aparafusadora de impacto/caixa a bateria

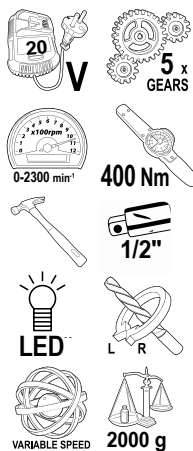
RDP-SCIW20-5 SOLO

Art.No	gross weight	in cartoon	barcode
030134	2.250 kg	5 pcs	3800123168253

R20 CORDLESS RATCHET WRENCH 3/8" 60NM LED SOLO RDP-SRW20

• [BG] Тресчотка акумулаторна • [RO] Clichet reincărcabil • [SR] Punjiva čegrtaljka • [MK] Рачка на полнење • [RU] Трещетка аккумуляторная • [SL] Raglja za ponovno polnjenje • [EL] Επαναφορτιζόμενη καστίνα • [HR] Punjiva čegrtaljka • [FR] Cliquet rechargeable • [IT] Cricchetto ricaricabile • [ES] Trinquete recargable • [PT] Catraca recarregável

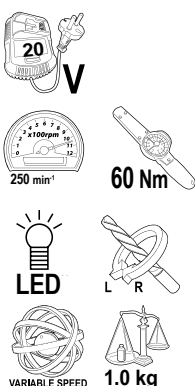
RDP-SRW20 SOLO

Art.No	gross weight	in cartoon	barcode
030225	3800972025127



R20 CORDLESS ROTARY HAMMER SDS-PLUS 1.2J SOLO RDP-SRH20

• [BG] Перфоратор акумулаторен безчетков без батерия и зарядно • [RO] Ciocan rotoper-cutor fără baterie și încărcător • [SR] Bežični čekić za vuču bez baterija i punjač
• [MK] Батериски ротирачки чекан без батерија и полнач • [RU] Аккумуляторный перфоратор без аккумулятора и зарядного устройства • [SL] Brezžični vrtljivi kladiv brez baterije in polnilnika • [EL] Περιστρέφόμενο σφύρι χωρίς μπαταρία και φορτιστή • [HR] Bežični okretni čekić bez baterije i punjača • [FR] Marteau rotatif sans fil sans batterie et chargeur
• [IT] Martello perforatore senza batteria e caricabatterie • [ES] Senorda rotacia martelo sin batería y cargador • [PT] Martelo perfurador a bateria

SDS+

1.2J



5000 min⁻¹



RDP-SRH20 SOLO

Art.No	gross weight	in cartoon	barcode
030135	3800123168239

BRUSHLESS CORDLESS ROTARY HAMMER SOLO RDP-SBRH20

• [BG] Перфоратор акумулаторен безчетков без батерия и зарядно • [RO] Ciocan rotoper-cutor fără baterie și încărcător • [SR] Bežični čekić za vuču bez baterija i punjač
• [MK] Батериски ротирачки чекан без батерија и полнач • [RU] Аккумуляторный перфоратор без аккумулятора и зарядного устройства • [SL] Brezžični vrtljivi kladiv brez baterije in polnilnika • [EL] Περιστρέφόμενο σφύρι χωρίς μπαταρία και φορτιστή • [HR] Bežični okretni čekić bez baterije i punjača • [FR] Marteau rotatif sans fil sans batterie et chargeur • [IT] Martello perforatore senza batteria e caricabatterie • [ES] Senorda rotacia martelo sin batería y cargador • [PT] Martelo perfurador a bateria



2.2J



4 functions

0-4500 min⁻¹

SDS+



RDP-SBRH20 SOLO

Art.No	gross weight	in cartoon	barcode
030151	2.710 kg	8	3800972012349

CORDLESS HANDLE MIXER SOLO RDP-SHM20

• [BG] Акумулаторен миксер без батерия и зарядно • [RO] Amestecator fără baterie și încărcător • [SR] Mešač bez baterija i punjač • [MK] Мешалка без батерија и полнач
• [RU] Миксер без аккумулятора и зарядного устройства • [SL] Mešalnik brez baterije in polnilnika • [EL] Δραπάνο Αναδευτήρας σφύρι χωρίς μπαταρία και φορτιστή
• [HR] Miješalica bez baterije i punjača • [FR] Mélangeur à poignée fil sans batterie et chargeur
• [IT] Maneggiare il mixer senza batteria e caricabatterie • [ES] Manlibro miksajfo sin batería y cargador • [PT] Misturadora manual



RDP-SHM20 SOLO

Art.No	gross weight	in cartoon	barcode
030152	4.850 kg	2 pcs	3800972014282

R20 CORDLESS ANGLE GRINDER RDP-SPAG20 SET

• [BG] Ъглошлайф акумулаторен безчетков • [RO] Polizor unghiular • [SR] Brusilica ugaona sa akumulatomom • [MK] Батериска брусилка • [RU] Аккумуляторная угловая шлифовальная машина
• [SL] Kotni brusilnik • [EL] Γωνιακός τροχός μπαταρίας • [HR] Aku kutna brusilica • [FR] Meuleuse d'angle sans • [IT] Smerigliatrice angolare • [ES] Amoladora angular • [PT] Rebarbadora



M14



RDP-SPAG20 SET

Art.No	gross weight	in cartoon	barcode
030226	3800972025455

R20 BRUSHLESS CORDLESS ANGLE GRINDER Ø125MM RDP-PBAG20

• [BG] Ъглошлайф акумулаторен безчетков • [RO] Polizor unghiular • [SR] Brusilica ugaona sa akumulatomom • [MK] Батериска брусилка • [RU] Аккумуляторная угловая шлифовальная машина
• [SL] Kotni brusilnik • [EL] Γωνιακός τροχός μπαταρίας • [HR] Aku kutna brusilica • [FR] Meuleuse d'angle sans • [IT] Smerigliatrice angolare • [ES] Amoladora angular • [PT] Rebarbadora

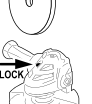

M14



RDP-PBAG20 SOLO

Art.No	barcode
030229	3800972026575

RDP-PBAG20 SET IN CASE

Art.No	barcode
030230	3800972026582

CORDLESS JIG SAW RDP-SJS20

• [BG] Прободеи трион акумулаторен • [RO] Ferstrau pendular • [SR] Ubodna testera sa akumulatomom • [MK] Акумулаторска уводна пила • [RU] Аккумуляторный лобзик • [SL] Akumulatorska vbodna žaga • [EL] Σέγα μπαταρίας • [HR] Akumulatorska ubodna pila • [FR] Scie sauteuse sans fil
• [IT] Seghetto alternativo • [ES] Inalámbrico jigsaw • [PT] Rebarbadora com bateria



RDP-SJS20 SOLO

Art.No	gross weight	in cartoon	barcode
030137	2.200 kg	5 pcs	3800123168246

RDP-SJS20 WITH 1 BATTERY 2Ah SET IN CASE

Art.No	gross weight	in cartoon	barcode
030210	3.100 kg	4 pcs	3800972005365

R20 CORDLESS RECIPROCATING SAW QUICK

RDP-PRS20 SOLO

• [BG] Акумулаторен саблевиден трион без батерия и зарядно • [RO] Ferastrau tip sabie fără baterie și încărcător • [SR] Sablajsta testera batteri bez baterija i punjač • [MK] Акумулаторска пила сабјарка без батерија и полнач • [RU] Акумулаторная маятниковый лобзик без аккумулятора изрядного устройства • [SL] Brezžični nihajna vobodna žaga brez baterije in polnilnika • [EL] Πριονι σεγα χωρίς μπαταρία και φορτιστή • [HR] Bežični recipročna pila bez baterije i punjača • [FR] Scie alternative sans fil sans batterie et chargeur • [IT] Sega alternativa senza batteria e caricabatterie • [ES] Sierra reciproca inalámbrica sin batería y cargador • [PT] Serra sabre sem bateria e carregador

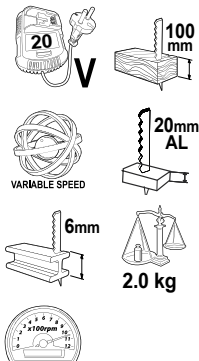

RDP-SRS20 SOLO

Art.No	gross weight	in cartoon	barcode
050205	2.00 kg	4 pcs	3800972026568

CORDLESS RECIPROCATING SAW SOLO RDP-SRS20

• [BG] Акумулаторен саблевиден трион без батерия и зарядно • [RO] Ferastrau tip sabie fără baterie și încărcător • [SR] Sablajsta testera batteri bez baterija i punjač • [MK] Акумулаторска пила сабјарка без батерија и полнач • [RU] Акумулаторная маятниковый лобзик без аккумулятора изрядного устройства • [SL] Brezžični nihajna vobodna žaga brez baterije in polnilnika • [EL] Πριονι σεγα χωρίς μπαταρία και φορτιστή • [HR] Bežični recipročna pila bez baterije i punjača • [FR] Scie alternative sans fil sans batterie et chargeur • [IT] Sega alternativa senza batteria e caricabatterie • [ES] Sierra reciproca inalámbrica sin batería y cargador • [PT] Serra sabre sem bateria e carregador

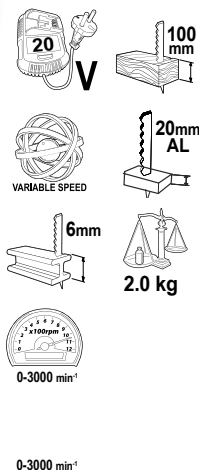

RDP-SRS20 SOLO

Art.No	gross weight	in cartoon	barcode
030138	2.230 kg	4 pcs	3800123168260

CORDLESS BRUSHLESS PRUNING SHEARS SOLO RDP-SPSH20

• [BG] Ножица овошчаро-лозарска акум. безчеткова • [RO] Foarfece pentru pomi și viticultură. fără perii • [SR] Makaze za voćarstvo i vinogradarstvo. bez četkica • [MK] Ножици за овошје и лозарство. без четкички • [RU] Ножницы для фруктов и виноградарства. бесщеточный • [SL] Škarje za sadjarstvo in vinogradništvo. brez krtačk • [EL] Ψαλίδι φρούτων και αμπελοφυρίας. χωρίς ψήκτρες • [HR] Škare za voćarstvo i vinogradarstvo. bez četkica • [FR] Ciseaux pour fruits et viticulture. sans brosse • [IT] Forbici per frutta e viticoltura. senza spazzole • [ES] Tijeras para fruta y viticultura. sin escobillas • [PT] Tesoura para frutas e viticultura. sem escova



RDP-SPSH20 SOLO

Art.No	gross weight	in cartoon	barcode
075718	---	---	3800972024106

CORDLESS CIRCULAR SAW SOLO RDP-SCS20

• [BG] Циркулар акумулаторен без батерия и зарядно • [RO] Ferastrau circular fără baterie și încărcător • [SR] Bežični cirkular bez baterija i punjač • [MK] Батериски циркулар без батерија и полнач • [RU] Акумулаторна дисковая пила без аккумулятора и зарядного устройства • [SL] Brezžična krozna žaga brez baterije in polnilnika • [EL] Δίσκοπριονο μπαταρίας χωρίς μπαταρία και φορτιστή • [HR] Aku kružna pila cirkular bez baterije i punjača • [FR] Scie circulaire sans fil sans batterie et chargeur • [IT] Sega circolare cordone senza batteria e caricabatterie • [ES] Sierra circular inalámbrica sin batería y cargador • [PT] Serra circular sem bateria e carregador

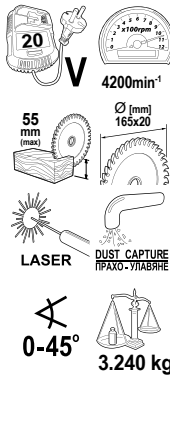

RDP-SCS20 SOLO

Art.No	gross weight	in cartoon	barcode
030139	3.600 kg	2 pcs	3800123168208

FOR RDP-SCS20

Art.No	gross weight	in cartoon	barcode
163143	0.240 kg	50 pcs	3800972005396

CORDLESS MITRE SAW SOLO RDP-SMS20

• [BG] Циркулар акумулаторен, настолен без батерия и зарядно • [RO] Ferastrau circular fără baterie și încărcător • [SR] Bežični cirkular bez baterija i punjač • [MK] Батериски циркулар без батерија и полнач • [RU] Акумулаторна дисковая пила без аккумулятора и зарядного устройства • [SL] Brezžična krozna žaga brez baterije in polnilnika • [EL] Δίσκοπριονο μπαταρίας χωρίς μπαταρία και φορτιστή • [HR] Aku kružna pila cirkular bez baterije i punjača • [FR] Scie circulaire sans fil sans batterie et chargeur • [IT] Sega circolare cordone senza batteria e caricabatterie • [ES] Sierra circular inalámbrica sin batería y cargador • [PT] Serra circular sem bateria e carregador

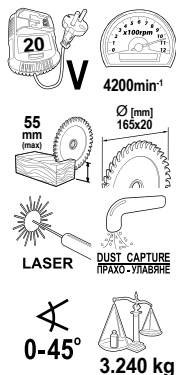

RDP-SMS20 SOLO

Art.No	gross weight	in cartoon	barcode
030162	---	---	3800972019782

CORDLESS RANDOM ORBIT SANDER SOLO RDP-SRSA20

• [BG] Ексцентършлиф акумулаторен без батерия и зарядно • [RO] Slefuitor orbital fără baterie și încărcător • [SR] Brusilica rotaciona bez baterija i punjač • [MK] Ексцентрична брусилка без батерија и полнач • [RU] Дельташлифмашина без аккумулятора и зарядного устройства • [SL] Ekscentrični brusilnik brez baterije in polnilnika • [EL] Εκκεντρο τριβείο χωρίς μπαταρία και φορτιστή • [HR] Ekscentrična brusilica bez baterije i punjača • [FR] Ponceuse excentrique sans fil sans batterie et chargeur • [IT] Levigatrice orbitale senza batteria e caricabatterie • [ES] Lijadora de órbita inalámbrica sin batería y cargador • [PT] Lixadeira de órbita aleatória sem fio sem bateria e carregador

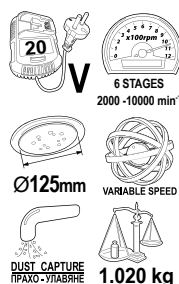

RDP-SRSA20

Art.No	gross weight	in cartoon	barcode
030140	1.200 kg	4 pcs	3800123168161

VELCRO SANDING SHEETS 150X150X100MM

11 HOLES 10 PCS. FOR MULTI-SANDERS

• [BG] Шкурка Velcro • [RO] Hârtie abrazivă Velcro • [SR] Brusni papir Velcro • [MK] Велкро со шкурка • [RU] Наждачная бумага на липучке • [SL] Velcro brusni papir • [EL] Γυαλόχαρτο Velcro • [HR] Brusni papir Velcro • [FR] Velcro de papier de verre • [IT] Velcro con carta vetrata • [ES] Velcro de papel de lija • [PT] Lixa Velcro

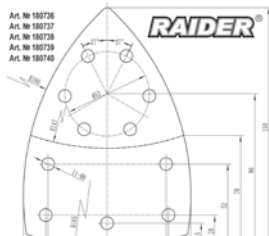

VELCRO SANDING SHEETS

Art.No	gross weight	in cartoon	barcode
180736			3800972025370
180737	---	---	3800972025387
180738			3800972025394
180739			3800972025400

VELCRO SANDING SHEETS 150X150X100MM

11 HOLES 10 PCS. FOR MULTI-SANDERS

• [BG] Шкурка Velcro • [RO] Hârtie abrazivă Velcro • [SR] Brusni papir Velcro • [MK] Велкро со шкурка • [RU] Наждачная бумага на липучке • [SL] Velcro brusni papir • [EL] Γυαλόχαρτο Velcro • [HR] Brusni papir Velcro • [FR] Velcro de papier de verre • [IT] Velcro con carta vetrata • [ES] Velcro de papel de lija • [PT] Lixa Velcro

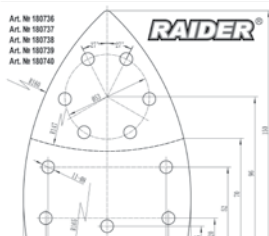

3 pcs. P60
3 pcs. P80
2 pcs. P120
2 pcs. P180

VELCRO SANDING SHEETS

Art.No	gross weight	in cartoon	barcode
180740	---	---	3800972025417

CORDLESS MULTI-TOOL SOLO RDP-SOMT20

• [BG] Многофункционален инструмент без батерия и зарядно • [RO] Unealta multifunctionala fără baterie și încărcător • [SR] Višenamenski alat bez baterija i punjač • [MK] Повеќенаменски алат без батерија и полнач • [RU] Многофункциональный инструмент без аккумулятора и зарядного устройства • [SL] Večnamensko orodje brez baterije in polnilnika • [EL] Πολυεργαλείο μπαταρίας χωρίς μπαταρία και φορτιστή • [HR] Višenamjenski alat bez baterije i punjača • [FR] Outil multifonctionnel sans fil sans batterie et chargeur • [IT] Multi-utensile oscillante senza batteria e caricabatteria • [ES] Herramienta multifuncional inalámbrica sin batería y cargador • [PT] Multi-ferramenta oscilante sem fio sem bateria e carregador

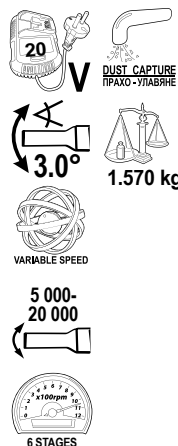

RDP-SOMT20 SOLO

Art.No	gross weight	in cartoon	barcode
030141	1.750 kg	4 pcs	3800123168178

CORDLESS MULTI-SANDER SOLO RDP-SMSA20

• [BG] Мултишлайф акумулаторен без батерия и зарядно • [RO] Multi-lame reîncărcabile fără baterie și încărcător • [SR] Punjiva sa više oštrica bez baterije i punjača • [MK] Може да се полни со повеќе сечила без батерија и полнач • [RU] Многолезвийный перезаряжаемый без аккумулятора и зарядного устройства • [SL] Več rezil za polnjenje brez baterije in polnilnika • [EL] Επαναφορτιζόμενη πολλαπλών λεπίδων χωρίς μπαταρία και φορτιστή • [HR] Punjiva s više oštrica bez baterije i punjača • [FR] Multilame rechargeable sans batterie ni chargeur • [IT] Multilama ricaricabile senza batteria e caricabatteria • [ES] Recargable multicuchillas sin batería ni cargador • [PT] Multi-lâmina recarregável sem bateria e carregador



RDP-SMSA20

Art.No	gross weight	in cartoon	barcode
040404	---	---	3800972025097

CORDLESS BELT SANDER SOLO RDP-SBS20

• [BG] Шлайф лентов акумулаторен без батерия и зарядно • [RO] Slefuitoare cu bandă fără acumulator fără baterie și încărcător • [SR] Akumulatorska tračna brusilica bez baterije i punjača • [MK] Безжична брусилка со ремен без батерија и полнач • [RU] Акумуляторная ленточная шлифовальная машина без аккумулятора и зарядного устройства • [SL] Akumulatorski tračni brusilnik brez baterije in polnilca • [EL] Ασύρματο ταινιοτριβείο χωρίς μπαταρία και φορτιστή • [HR] Akumulatorska tračna brusilica bez baterije i punjača • [FR] Ponceuse à bande sans fil sans batterie ni chargeur • [IT] Levigatrice a nastro a batteria senza batteria e caricabatteria • [ES] Lijadora de banda inalámbrica sin batería y cargador • [PT] Lixadeira de cinta sem fio sem bateria e carregador



RDP-SBS20

Art.No	gross weight	in cartoon	barcode
043202	---	---	3800972025066

CORDLESS HOT MELT GLUE GUN SOLO RDP-SGLG20

• [BG] Пистолет за топло лепене акумулаторен без батерия и зарядно • [RO] Pistol de lipit fara acumulator si incarcator • [SR] Akumulatorski pištol za lepljenje bez baterije i punjača • [MK] Безжичен лепак пистолет без батерија и полнач • [RU] Акумуляторный клеевой пистолет без аккумулятора и зарядного устройства • [SL] Akumulatorska pištola za lepljenje brez baterije in polnilnika • [EL] Επαναφορτιζόμενο πιστόλι κόλλησης χωρίς μπαταρία και φορτιστή • [HR] Akumulatorski pištolj za lijepljenje bez baterije i punjača • [FR] Pistolet à colle sans fil sans batterie et chargeur • [IT] Pistola per colla a batteria senza batteria e caricabatteria • [ES] Pafilata gluilo sen baterio kaj senšargilo sin batería y cargador • [PT] Arma de cola sem fio sem bateria e carregador

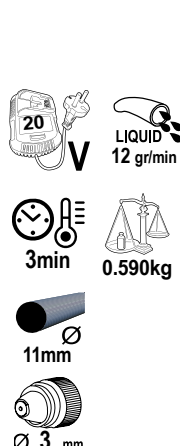

RDP-SGLG20 SOLO

Art.No	gross weight	in cartoon	barcode
030154	0.660 kg	4 pcs	3800972014428

CORDLESS HEAT GUN SOLO RDP-SHG20

• [BG] Пистолет за горещ въздух акумулаторен без батерия и зарядно • [RO] Pistol cu aer cald fără baterie și încărcător • [SR] Pištoľ za vrelı vazduh bez baterije i punjača • [MK] Фен без батериија и полнач • [RU] Пистолет горячего воздуха без аккумулятора и зарядного устройства • [SL] Vroca zračna pištola brez baterije in polnilnika • [EL] Πιστολι φερμου αερα χωρίς μπαταρία και φορτιστή • [HR] Pištoľ za vrući zrak bez baterije i punjača • [FR] Arbre à air chaud sans batterie et chargeur • [IT] Pistola aria calda senza batteria e caricabatterie • [ES] Pistola de aire caliente sin batería y cargador • [PT] Soprador de ar quente sem bateria e carregador



RDP-SHG20 SOLO

Art.No	barcode
030160	3800972018884

CORDLESS COMBI AIR STAPLER AND NAILER SOLO RDP-SST20

• [BG] Акумулаторен комбиниран такер без батерия и зарядно • [RO] Capsator fără fir combinat fără baterie și încărcător • [SR] Kombinovani akumulatorski klamerica bez baterije i punjača • [MK] Комбиниран безжичен спојувач без батериија и полнач • [RU] Беспроводной степлер комбинированный без аккумулятора и зарядного устройства • [SL] Kombinirana akumulatorska spenjača brez baterije in polnilnika • [EL] Συρραπτικό συρραπτικό συνδυασμένο μπαταρία και φορτιστή • [HR] Kombinirani bežični klamerica bez baterije i punjača • [FR] Agrafeuse sans fil combinée • [IT] Cucitrice cordless combinata senza batteria e caricabatterie • [ES] Senk-abela stapler kombinata sin batería y cargador • [PT] Grampeador sem fio combinado sem bateria e carregador

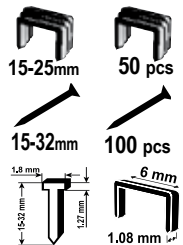

TYPE 47 TYPE 55

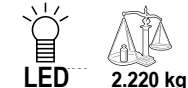

RDP-SST20 SOLO

Art.No	gross weight	in cartoon	barcode
030153	2.470 kg	4 pcs	3800972014411

STAPLES FOR CORDLESS STAPLER RDP-SST20

• [BG] Скоби за акумулаторен пневматичен такер • [RO] Capse pentru capsator fără fir RDP-SST20 • [SR] Držaci za bežični spenjač RDP-SST20 • [MK] Муниција за хефталка RDP-SST20 • [RU] Скобы для беспроводного степлера RDP-SST20 • [SL] Sponke RDP-SST20 • [EL] Συρραπτικά για ασύρματο συρραπτικό RDP-SST20 • [HR] Klamerice za klamerica RDP-SST20 • [FR] Sauterelles RDP-SST20 • [IT] Morsetti di inclinazione RDP-SST20 • [ES] Grapoj por sendrata stanpilo RDP-SST20 • [PT] Grampos para grampeador sem fio RDP-SST20

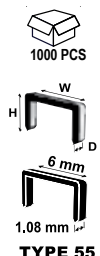

Art.No	H (mm)	W (mm)	D (mm)	barcode
511412	14	6	1.08	3800972015661
511413	16	6	1.08	3800972015678
511414	20	6	1.08	3800972015685
511415	25	6	1.08	3800972015692

NAILS FOR CORDLESS STAPLER RDP-SST20

• [BG] Пирони за акумулаторен такер • [RO] Cuie pentru capsator fără fir RDP-SST20 • [SR] Klamerice za pneumatsku heftalicu RDP-SST20 • [MK] Муниција за хефталка RDP-SST20 • [RU] Гвозди для беспроводного степлера RDP-SST20 • [SL] Sponke RDP-SST20 • [EL] Καρφιά για ασύρματο συρραπτικό RDP-SST20 • [HR] Klamerice za RDP-SST20 • [FR] Sauterelles RDP-SST20 • [IT] Morsetti di inclinazione RDP-SST20 • [ES] Šlosiljoj por sendrata grapilo RDP-SST20 • [PT] Pregos para grampeador sem fio RDP-SST20

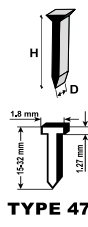

TYPE 47

Art.No	H (mm)	D (mm)	barcode
511416	15	1.08	3800972015708
511417	20	1.08	3800972015715
511418	25	1.08	3800972015722
511419	32	1.08	3800972015739

CORDLESS SPRAY GUN SOLO RDP-SSGC20

• [BG] Пистолет за боя без батерия и зарядно • [RO] Pistol de pulverizare fără acumulator și încărcător • [SR] Akumulatorski pištoľ za prskanje bez baterija i punjač • [MK] Безжичен пиштољ без батериија и полнач • [RU] Акумулаторный пистолет без аккумулятора и зарядного устройства • [SL] Akumulatorska brizgalna pištola brez baterije in polnilnika • [EL] Ακουστικό ψεκαστήρα χωρίς μπαταρία και φορτιστή • [HR] Akumulatorski pištoľ za prskanje bez baterije i punjača • [FR] Pistolet sans fil sans batterie et chargeur • [IT] Pistola a batteria senza batteria e caricatore • [ES] Śnurfunda pistolo sen baterio kaj senšargilo • [PT] Pistolet sans fil sans batterie et chargeur



NOZZLES & FILTERS SET FOR CORDLESS SPRAY GUN RDP-SSGC20



RDP-SSGC20 SOLO

Art.No	gross weight	in cartoon	barcode
074202	1.620 kg	4	3800972014770

NOZZLES AND FILTERS FOR RDP-SSGC20 Ø1.5, 1.8, 2.2 mm

Art.No	gross weight	in cartoon	barcode
110914	0.070 kg	300	3800972015906

CORDLESS BENCH GRINDER SOLO RDP-SCBG20

• [BG] Шмиргел акумулаторен без батерия и зарядно • [RO] Acumulator șmirghel fără baterie și încărcător • [SR] Akumulatorski brusni papir bez baterije i punjača • [MK] Акумулаторска шкурка без батериија и полнач • [RU] Точило без аккумулятора и зарядного устройства • [SL] Akumulatorski brusni papir brez baterije in polnilnika • [EL] Γυαλόχαρτο συσσωρευτή χωρίς μπαταρία και φορτιστή • [HR] Akumulatorski brusni papir bez baterije i punjača • [FR] Papier abrasif accumulateur sans batterie ni chargeur • [IT] Carta vetrata ad accumulatore senza batteria e caricabatteria • [ES] Lija acumuladora sin batería y cargador • [PT] Lixa de acumulador sem bateria e carregador



RDP-SCBG20 SOLO

Art.No	gross weight	in cartoon	barcode
061201	----	---	3800972023543

GRINDING WHEEL Ø50XØ13 MM

Art.No	gross weight	in cartoon	barcode
165128	----	---	3800972025042
165129	----	---	3800972025059

CORDLESS PLANER SOLO RDP-SEP20

• [BG] Ренде акумулаторно без батерия и зарядно • [RO] Rindea reincărcabilă fără baterie și încărcător • [SR] Punjiva renda bez baterije i punjača • [MK] Планер што се полни без батерија и полнач • [RU] Электрорубанок без аккумулятора и зарядного устройства • [SL] Akumulatorski skobeljnik brez baterije in polnilca • [EL] Επαναφορτιζόμενη πλάνη χωρίς μπαταρία και φορτιστή • [HR] Punjiva blanjalica bez baterije i punjača • [FR] Rabot rechargeable sans batterie ni chargeur • [IT] Pialla ricaricabile senza batteria e caricabatteria • [ES] Cepilladora recargable sin batería ni cargador • [PT] Plaina recarregável sem bateria e carregador



RDP-SEP20

Art.No	gross weight	in carton	barcode
055203	----	---	3800972023550

BRUSHLESS CORDLESS POLISHER SOLO RDP-SPC20

• [BG] Полирмашина акумулаторна без батерия и зарядно • [RO] Polizor baterie fara baterie si incarcator • [SR] Uredaj za poliranje baterija bez baterije i punjača • [MK] Полирање на батерија без батерија и полнач • [RU] Аккумуляторный полировщик без аккумулятора и зарядного устройства • [SL] Baterijski polirnik brez baterije in polnilca • [EL] Γυαλιστικό μπαταρίας χωρίς μπαταρία και φορτιστή • [HR] Baterijska polirka bez baterije i punjača • [FR] Polisseuse à batterie sans batterie ni chargeur • [IT] Lucidatrice a batteria senza batteria e caricabatteria • [ES] Pulidora de batería sin batería ni cargador • [PT] Polidora de bateria sem bateria e carregador



RDP-SPC20

Art.No	gross weight	in carton	barcode
041603	----	---	3800972023567

CORDLESS CAULKING GUN SOLO RDP-SCG20

• [BG] Пистолет за силикон акумулаторен без батерия и зарядно • [RO] Pistol reincărcabil din silicop • [SR] Punjivi silikonski pištolj • [MK] Силиконски пиштол за полнење • [RU] Перезаряжаемый силиконовый пистолет • [SL] Silikonska pištola za polnjenje • [EL] Επαναφορτιζόμενο πιστόλι σιλικόνης • [HR] Punjivi silikonski pištolj • [FR] Pistolet en silicone rechargeable • [IT] Pistola in silicone ricaricabile • [ES] Pistola de silicona recargable • [PT] Pistola de silicone recarregável



RDP-SCG20

Art.No	gross weight	in carton	barcode
041604	----	---	3800972023574

CORDLESS BLOWER VACUUM AND SHREDDER SOLO RDP-SEBV20

• [BG] Листосъбирач акумулаторен без батерия и зарядно • [RO] Bateria colectoare de frunze • [SR] Baterija za kolektor lišća • [MK] Лист колекторска батерија • [RU] Аккумулятор для сбора листьев • [SL] Baterija za zbiralnik listov • [EL] Μπαταρία συλλεκτική φύλλων • [HR] Baterija za sakupljanje lišća • [FR] Batterie récupérateur de feuilles • [IT] Batteria raccogli foglie • [ES] Bateria recolectora de hojas • [PT] Bateria coletora de folhas



RDP-SEBV20

Art.No	gross weight	in carton	barcode
077403	----	---	3800972023581

CORDLESS KNAPSACK SPRAYER SOLO RDP-SBKMD20

• [BG] Пръскачка акумулаторна без батерия и зарядно • [RO] Pulverizator cu baterie • [SR] Akumulatorska prskalica • [MK] Распрскувач на батерија • [RU] Аккумуляторный опрыскиватель • [SL] Baterijski razpršilec • [EL] Ψεκαστήρας μπαταρίας • [HR] Baterijska prskalica • [FR] Pulvérisateur à batterie • [IT] Spruzzatore a batteria • [ES] Pulverizador de batería • [PT] Pulverizador de bateria



RDP-SBKMD20

Art.No	gross weight	in carton	barcode
098106	----	---	3800972023598

CORDLESS GRASS SHEARS & HEDGE TRIMMER & RAKER 3IN1 SOLO RDP-SGSS20

• [BG] Ножица за трева и храсти акумулаторна без батерия и зарядно • [RO] Foarfecă fără fir pentru iarbă și arbuști • [SR] Akumulatorske makaze za travu i žbunje • [MK] Безжичен ножица за трева и грмушки • [RU] Аккумуляторные ножницы для травы и кустарников • [SL] Akumulatorske škarje za travo in grmičevje • [EL] Ασύρματο ψαλίδι χόρτου και θάμνων • [HR] Akumulatorske škare za travu i grmlje • [FR] Cisailles à gazon et arbustes sans fil • [IT] Forbici per erba e arbusti a batteria • [ES] Tijeras cortacésped y para arbustos a batería • [PT] Tesouras de grama e arbustos sem fio



RDP-SGSS20

Art.No	gross weight	in carton	barcode
075553	----	---	3800972023604

CORDLESS DRY VACUUM CLEANER SOLO RDP-SMWC20

• [BG] Прахосмукачка за сухо акумулаторна без батерия и зарядно • [RO] Aspirator pentru baterie uscata • [SR] Usisivač za suhu bateriju • [MK] Правосмукалка за сува батерија
 • [RU] Пылесос для сухой батареи • [SL] Sesalnik za suho baterijo • [EL] Ηλεκτρική σκούπα για στεγνή μπαταρία • [HR] Usisivač za suhu bateriju • [FR] Aspirateur pour batterie sèche • [IT] Aspirapolvere per batteria a secco • [ES] Aspirador para batería seca • [PT] Aspirador para bateria seca



RDP-SMWC20

Art.No	gross weight	in cartoon	barcode
090329	---	---	3800972025103

3 PCS. FILTER FOR VACUUM CLEANER

Art.No	gross weight	in cartoon	barcode
090331	---	---	3800972025424



WET & DRY VACUUM CLEANER SOLO RDP-SDWC20

• [BG] Прахосмукачка за сухо и мокро • [RO] Aspirator umed/uscat fara acumulator si incarcator
 • [SR] Usisivača za mokro i suvo [MK] Правосмукалка за суво и мокро • [RU] Мокрый и сухой пылесос • [SL] Sesalnik za mokro in suho • [EL] Ηλεκτρική σκούπα για υγρή και ξηρή
 • [HR] Usisivač za mokre i suhe podloge • [FR] Aspirateur • [IT] Aspirapolvere
 • [ES] Polvosuçilo • [PT] Aspirador "WET & DRY"



VACUUM
8 kPa



15L



4 kg

RDP-SDWC20 SOLO

Art.No	gross weight	in cartoon	barcode
090319	4.900 kg	1	3800972015883

ASH VACUUM CLEANER SOLO RDP-SWC20

• [BG] Прахосмукачка за пепел • [RO] Aspirator pentru cenusa fara acumulator si incarcator
 • [SR] Usisivač za pepeo [MK] Правосмукалка за пепел • [RU] Пепла пылесос
 • [SL] Sesalnik pepela • [EL] Σκούπα φίλτρο σταχτήρ • [HR] Usisivač za uklanjanje pepela
 • [FR] Aspirateur de cendre • [IT] Aspirapolvere per cenere
 • [ES] Ash maiplena • [PT] Aspirador de cinzas



VACUUM
8 kPa



2.500 kg

Art.No	gross weight	in cartoon	barcode
090315	3.500 kg	1	3800972015845

HEPA FILTER FOR RD-WC06, RDP-SWC20

Art.No	gross weight	in cartoon	barcode
090320	0.280 kg	24 pcs	3800972015890



R20 BRUSHLESS CORDLESS WET & DRY VACUUM CLEANER 10L HEPA SOLO RDP-SDWCH20

• [BG] Прахосмукачка за сухо и мокро • [RO] Aspirator umed/uscat fara acumulator si incarcator
 • [SR] Usisivača za mokro i suvo [MK] Правосмукалка за суво и мокро • [RU] Мокрый и сухой пылесос • [SL] Sesalnik za mokro in suho • [EL] Ηλεκτρική σκούπα για υγρή και ξηρή
 • [HR] Usisivač za mokre i suhe podloge • [FR] Aspirateur • [IT] Aspirapolvere
 • [ES] Polvosuçilo • [PT] Aspirador "WET & DRY"



VACUUM
15 kPa



3.4 kg

RDP-SDWCH20 SOLO

Art.No	gross weight	in cartoon	barcode
090330	4.00 kg	1	3800972025363

CORDLESS MINI AIR COMPRESSOR SOLO RDP-SAC20

• [BG] Мини компресор акумулаторен без батерия и зарядно • [RO] Mini compresor reîncărcabil • [SR] Punjivi mini kompresor • [MK] Мини компресор на полнење • [RU] Перезаряжаемый мини-компрессор • [SL] Mini kompresor za polnjenje • [EL] Επαναφορτιζόμενος μίνι συμπιεστής • [HR] Punjivi mini kompresor • [FR] Mini compresseur rechargeable • [IT] Mini compressore ricaricabile • [ES] Mini compresor recargable • [PT] Minicompressor recarregável



7
Bar



RDP-SAC20 SOLO

Art.No	gross weight	in cartoon	barcode
089410	---	---	3800972025134

CORDLESS WORK FAN SOLO RDP-SWF20

• [BG] Вентилатор акумулаторен без батерия и зарядно • [RO] Bateria ventilatorului
 • [SR] Baterija ventilatora • [MK] Батерија на вентилатор • [RU] Батарея вентилятора
 • [SL] Baterija ventilatorja • [EL] Μπαταρία ανεμιστήρα • [HR] Baterija ventilatora
 • [FR] Batterie du ventilateur • [IT] Batteria della ventola • [ES] Bateria del ventilador
 • [PT] Bateria do ventilador



RDP-SWF20 SOLO

Art.No	gross weight	in cartoon	barcode
039711	---	---	3800972023611

R20 CORDLESS MOBILE LED SPOTLIGHT 35W 100LED

5000LM 6000K SOLO RDP-SWL20

• [BG] Прожектор акумулаторен • [RO] Bateria ventilatorului • [SR] Baterija ventilatora • [MK] Батерија на вентилятор • [RU] Батарея вентилятора • [SL] Baterija ventilatorja • [EL] Μπαταρία ανεμιστήρα • [HR] Baterija ventilatora • [FR] Batterie du ventilateur • [IT] Batteria della ventola • [ES] Bateria del ventilador • [PT] Bateria do ventilador



Art.No	gross weight	in cartoon	barcode
039712	---	---	3800972023628

CORDLESS LED WORK LIGHT 3 LED SOLO RDP-SCLWL20

• [BG] Лампа акумулаторна без батерия и зарядно • [RO] Lampă reîncărcabilă • [SR] Punjiva lampa • [MK] Светилка за полнење • [RU] Перезаряжаемая лампа • [SL] Svetilka za polnjenje • [EL] Επαναφορτιζόμενη λάμπα • [HR] Punjiva lampa • [FR] Lampe rechargeable • [IT] Lampada ricaricabile • [ES] Lámpara recargable • [PT] Lámpada recarregável



RDP-SCLWL20 SOLO

Art.No	gross weight	in cartoon	barcode
039714	---	---	3800972025141

ADAPTER USB WITH LAMP



Art.No	gross weight	in cartoon	barcode
039706	---	---	3800972014442

BRUSHLESS CORDLESS BRUSH CUTTER SOLO RDP-SBBC20

• [BG] Коса акумулаторна безчеткова с нож и корда съваема • [RO] Mașină de tuns fără perii, fără fir, cu cuțit și șnur pliabil • [SR] Akumulatorska mašina za šišanje bez četkica sa nožem i sklopivim kablom • [MK] Безжична машинка за коса без четкички со нож и кабел што се преклопува • [RU] Бесщеточная беспроводная машинка для стрижки травы с ножом и складным шнуром • [SL] Brezkrtačni akumulatorski strižnik z nožem in zlozljivo vrvico • [EL] Κουρευτική κουρευτική μηχανή χωρίς βούρτσες με μαχαίρι και αναδιπλούμενο κορδόνι • [HR] Akumulatorski aparat za šišanje bez četkica s nožem i sklopivim kablom • [FR] Tondeuse à cheveux sans fil Brushless avec couteau et cordon pliable • [IT] Tagliacapelli cordless senza spazzole con coltello e cordino pieghevole • [ES] Cortapelos inalámbrico sin escobillas con cuchillo y cable plegable • [PT] Máquina de cortar cabelo sem escova com faca e cabo dobrável



RDP-SBBC20 SOLO

Art.No	gross weight	in cartoon	barcode
075716	---	---	3800972022812

BRUSHLESS CORDLESS BRUSH CUTTER RDP-SBBC20 SET

• [BG] Коса акумулаторна безчеткова с нож и корда съваема • [RO] Mașină de tuns fără perii, fără fir, cu cuțit și șnur pliabil • [SR] Akumulatorska mašina za šišanje bez četkica sa nožem i sklopivim kablom • [MK] Безжична машинка за коса без четкички со нож и кабел што се преклопува • [RU] Бесщеточная беспроводная машинка для стрижки волос с ножом и складным шнуром • [SL] Brezkrtačni akumulatorski strižnik z nožem in zlozljivo vrvico • [EL] Κουρευτική κουρευτική μηχανή χωρίς βούρτσες με μαχαίρι και αναδιπλούμενο κορδόνι • [HR] Akumulatorski aparat za šišanje bez četkica s nožem i sklopivim kablom • [FR] Tondeuse à cheveux sans fil Brushless avec couteau et cordon pliable • [IT] Tagliacapelli cordless senza spazzole con coltello e cordino pieghevole • [ES] Cortapelos inalámbrico sin escobillas con cuchillo y cable plegable • [PT] Máquina de cortar cabelo sem escova com faca e cabo dobrável



RDP-SBBC20 SET

Art.No	gross weight	in cartoon	barcode
075711	---	---	3800972016668

POLE SAW HEAD WITH TUBE FOR RDP-SBBC20

• [BG] Кастрачка • [RO] Capul de ferăstrău pol cu tub • [SR] Polna testera • [MK] Полјакот виде глава • [RU] Насадка для резки кустов • [SL] Glava žaga s cevjo • [EL] Ο πόλος είδε το κεφάλι με σωλήνα • [HR] Poljak vidio • [FR] Scie à perche • [IT] Palo vide • [ES] Poluso vidis • [PT] Serra de poste



Art.No	barcode
075712	3800972016675

HEDGE TRIMMER HEAD WITH TUBE FOR RDP-SBBC20

• [BG] Резачка за храсти • [RO] Cap de tuns cu balamuc cu tub • [SR] Glava trimera za živice sa cevkom • [MK] Тример за сечење на храст • [RU] Насадка триммера • [SL] Glava škarje za živo mejo • [EL] Κεφαλή κοπής φρακτών • [HR] Glava trimera za živicu • [FR] Tête de taille-haie • [IT] Testa del tagliasiapi • [ES] Tondilo de heño • [PT] Aparador de cerca viva



Art.No	barcode
075713	3800972016682

CORDLESS POLE SAW RDP-SPS20 SET

• [BG] Кастрачка акумулаторна • [RO] Fierăstrău de stâlp fără fir • [SR] Akumulatorska polovna testera • [MK] Бежичена тестера • [RU] Акумуляторный кусторез • [SL] Akumulatorski škari • [EL] Ασύρματο πριόνι • [HR] Akumulatorska pila • [FR] Scie à perche sans fil • [IT] Sega polare a batteria • [ES] Sennova stangeto vidis • [PT] Serra sem fio

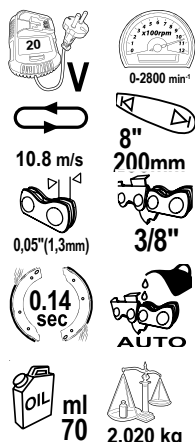

RDP-SPS20 WITH 1 BATTERY 2Ah SET

Art.No	barcode
075708	3800972016637

CORDLESS LAWN MOWER SOLO RDP-SLM20

• [BG] Акумулаторна косачка без батерия и зарядно • [RO] Mașină de tuns iarba fără baterie și încărcător • [SR] Kosilica za travu bez baterije i punjača • [MK] Батериска косилка за трева без батерија и полнач • [RU] Акумуляторная косилка без аккумулятора и зарядного устройства • [SL] Akumulatorska kosilica brez baterije in polnilnika • [EL] Χλοοκοπτικό χωρίς μπαταρία και φορτιστή • [HR] Akumulatorske kosilice bez baterije i punjača • [FR] Tondeuse à gazon sans batterie et chargeur • [IT] Tosaerba senza batteria e caricabatterie • [ES] Gazontondilo sin batería y cargador • [PT] Corta relvas sem bateria e carregador

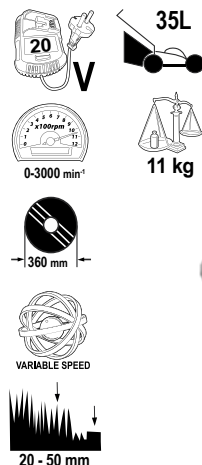

RDP-SLM20 SOLO

Art.No	gross weight	barcode
075328	12.500 kg	3800972009448

FOR RDP-SLM20 SOLO

Art.No	gross weight	barcode
110287	0.500 kg	3800972010451

CORDLESS HEDGE TRIMMER SOLO RDP-SCHT20

• [BG] Резачка за храсти без батерия и зарядно • [RO] Trimmer pt. gard fără baterie și încărcător • [SR] Bežični trimer za živu ogradu bez baterija i punjača • [MK] Бежичен тример со жива хед без батерија и полнач • [RU] Акумуляторный кусторез без аккумулятора и зарядного устройства • [SL] Akumulatorski škari za živo mejo brez baterije in polnilnika • [EL] Ασύρματο φρένο μπαταρία και φορτιστή • [HR] Akumulatorski trimer za živu ogradu bez baterije i punjača • [FR] Taille-haie sans fil sans batterie et chargeur • [IT] Tagliasiepi a batteria senza batteria e caricabatterie • [ES] Senkabra hegelezurilo sin batería y cargador • [PT] Corta-sebes sem bateria e carregador

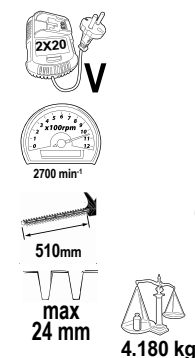

RDP-SCHT20 SOLO

Art.No	gross weight	in cartoon	barcode
075707	4.650 kg	2 pcs	3800972014688

BRUSHLESS CORDLESS GARDEN PRUNER RDP-SBGP20 SET

• [BG] Резачка акумулаторна • [RO] Rezač za baterije • [SR] Резач за батерије • [MK] Секач за батерии • [RU] Акумуляторный резак • [SL] Baterijski rezalnik • [EL] Κόφτης μπαταρίας • [HR] Baterijski rezač • [FR] Coupe-batterie • [IT] Taglierina a batteria • [ES] Cortador de batería • [PT] Cortador de bateria



RDP-SBGP20 SET

Art.No	gross weight	in cartoon	barcode
075719	---	---	3800972024274

SAW CHAIN 100 MM

Art.No	gross weight	in cartoon	barcode
140126	---	---	3800972024366

GUIDE BAR 100 MM

Art.No	gross weight	in cartoon	barcode
140127	---	---	3800972024373

R20 CORDLESS GARDEN PRUNER RDP-CGP20

• [BG] Резачка акумулаторна • [RO] Rezač za baterije • [SR] Резач за батерије • [MK] Секач за батерии • [RU] Акумуляторный резак • [SL] Baterijski rezalnik • [EL] Κόφτης μπαταρίας • [HR] Baterijski rezač • [FR] Coupe-batterie • [IT] Taglierina a batteria • [ES] Cortador de batería • [PT] Cortador de bateria



Art.No	barcode
075731	3800972028012

POLE 2.4M FOR CORDLESS GARDEN PRUNER RDP-CGP20

Art.No	barcode
075732	3800972028029



CORDLESS CHAIN SAW WITHOUT BATTERY AND CHARGER RDP-SCHS20

• [BG] Резачка акумулаторна • [RO] Ferăstrăie fără fir • [SR] Akumulatorska motorna testera • [MK] Бежичена тестера • [RU] Акумуляторная цепная пила • [SL] Brezžična motorna žaga
• [EL] Επαναφορτιζόμενο αλυσόπριονο • [HR] Akumulatorska motorna pila • [FR] Scie sans fil • [IT] Sega a batteria • [ES] Sendrata sego • [PT] Serra sem fio

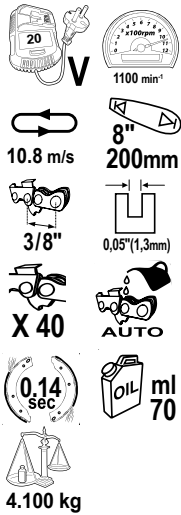

RDP-SCS20 SOLO

Art.No	barcode
075710	3800972016651

RDP-SCS20 WITH 1 BATTERIES 3Ah SET

Art.No	barcode
075709	3800972016644

GUIDE BAR 10"

Art.No	barcode
141315	3800972019751

BRUSHLESS CORDLESS CHAIN SAW SOLO RDP-SBCS20

• [BG] Резачка безчеткова акумулаторна без батерия и зарядно • [RO] Fierăstrău cu lant fara acumulator si incarcator • [SR] Akumulatorska motorna testera bez baterija i punjač • [MK] Бежичен моторна пила без батерија и полнач • [RU] Акумуляторная цепная пила без аккумулятора и зарядного устройства • [SL] Brezžična motorna žaga brez baterije in polnilnika • [EL] Επαναφορτιζόμενο αλυσόπριονο χωρίς μπαταρία και φορτιστή • [HR] Akumulatorska motorna pila bez baterije i punjača • [FR] Scie à chaîne sans fil sans batterie et chargeur • [IT] Motosega a batteria senza batteria e caricabatterie • [ES] Cervojo sin batería y cargador • [PT] Motosserra sem bateria e carregador



RDP-SBCS20 SOLO

Art.No	gross weight	in cartoon	barcode
030155	4.800 kg	2 pcs	3800972014435

SYSTEM STARTER KIT RDP-R20 SYSTEM

• [BG] Комплект батерия и зарядно • [RO] Set acumulator si incarcator • [SR] Set baterija i punjač • [MK] Батерија и полнач сет • [RU] Аккумулятор и зарядное устройство сет • [SL] Baterija iv polnillec baterij set • [EL] Μπαταρία και φορτιστή сет • [HR] Baterije i punjača set • [FR] Batterie et chargeur set • [IT] Batteria e caricabatterie set • [ES] Batería y cargador set • [PT] Bateria e carregador set



Art.No	gross weight	in cartoon	barcode
032120	0.980 kg	4 pcs	3800123168307

BATTERY PACK RDP-R20 SYSTEM

• [BG] Батерия • [RO] Acumulator • [SR] Baterija • [MK] Батерија • [RU] Аккумулятор • [SL] Baterija • [EL] Μπαταρία • [HR] Baterija • [FR] Batterie • [IT] Batteria • [ES] Batería • [PT] Bateria

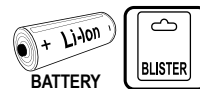

Art.No	V	Ah	net weightkg	gross weight	in cartoon	barcode
131152	20	2	0.700	0.860	10 pcs	3800972005310
131153	20	4	0.760	0.850	10 pcs	3800972005327
131161	20	6	0.900	0.960	10 pcs	3800972014718
131164	20	8	--	---	--- pcs	3800972025073

CHARGER RDP-R20 SYSTEM

• [BG] Зарядно • [RO] Incarcator • [SR] Punjač • [MK] Полнач на батерии • [RU] Зарядное устройство • [SL] Polnillec baterij • [EL] Φορτιστής μπαταρίας • [HR] Punjač baterije • [FR] Chargeur de batterie • [IT] Caricabatterie • [ES] Cargador de batería • [PT] Carregador de bateria



Art.No	Ah	net weightkg	gross weight	in cartoon	barcode
039703	2.4	0.450	0.500	10 pcs	3800123168291
039704	3.5	0.500	0.550	10 pcs	3800972005334

RAPID CHARGER 8A AIR COOLED FOR SERIES RDP-R20 SYSTEM

• [BG] Бързо зарядно • [RO] Incarcator rapid • [SR] Brzi punjač • [MK] Брз полнач • [RU] Быстрое зарядное устройство • [SL] Hitri polnillec • [EL] Γρήγορος φορτιστής • [HR] Brzi punjač • [FR] Chargeur rapide • [IT] Caricatore veloce • [ES] Cargador rápido • [PT] Carregador rápido



Art.No	gross weight	in cartoon	barcode
039713	---	---	3800972025080

DUAL CHARGER RDP-R20 SYSTEM

• [BG] Зарядно двойно • [RO] Incarcator dual • [SR] Dvojni punjač • [MK] Двоен полнач на батери
• [RU] Двойное зарядное устройство • [SL] Dvojni polnilnik • [EL] Διπλό φορτιστή • [HR] Dvostruki
punjač • [FR] Double chargeur • [IT] Caricatore doppio • [ES] Doble cargador • [PT] Carregador duplo

2x3A



Art.No	net weightkg	gross weight	in cartoon	barcode
039707	0.900	0.940	10 pcs	3800972014459

CORDLESS SCREWDRIVER RD-CSCLO4

[BG] Отвертка аккумуляторна • [RO] Șurubelniță fără fir • [SR] Akumulatorski odvijač • [MK] Бижичен шрафцигер • [RU] Аккумуляторная отвертка • [SL] Akumulatorski vijačnik • [EL] Κατσαβίδι μπαταρίας • [HR] Aku odvijač • [FR] Tournevis sans fil • [IT] Avvitatore a batteria • [ES] Destornillador inalámbrico • [PT] Aparafusadora sem fio

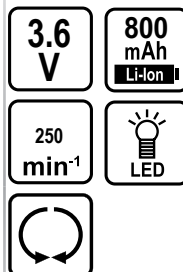

Art.No	gross weight	in cartoon	barcode
031201	2.2 kg	8 pcs	3800972001558

CORDLESS SCREWDRIVER RDP-CSCLO1

[BG] Отвертка аккумуляторна • [RO] Șurubelniță fără fir • [SR] Akumulatorski odvijač • [MK] Бижичен шрафцигер • [RU] Аккумуляторная отвертка • [SL] Akumulatorski vijačnik • [EL] Κατσαβίδι μπαταρίας • [HR] Aku odvijač • [FR] Tournevis sans fil • [IT] Avvitatore a batteria • [ES] Destornillador inalámbrico • [PT] Aparafusadora sem fio

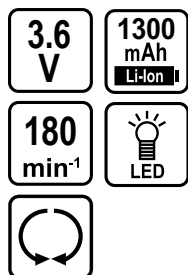

Art.No	gross weight	in cartoon	barcode
031106	2.2 kg	8 pcs	3800123162305

CORDLESS DRILL RDP-CDL30 BLACK EDITION

[BG] Отвертка аккумуляторна • [RO] Șurubelniță fără fir • [SR] Akumulatorski odvijač • [MK] Бижичен шрафцигер • [RU] Аккумуляторная отвертка • [SL] Akumulatorski vijačnik • [EL] Κατσαβίδι μπαταρίας • [HR] Aku odvijač • [FR] Tournevis sans fil • [IT] Avvitatore a batteria • [ES] Destornillador inalámbrico • [PT] Aparafusadora sem fio

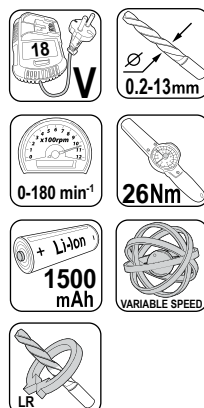

Art.No	gross weight	in cartoon	barcode
030214	2.2 kg	8 pcs	3800972016491

CORDLESS DRILL RD-CDL33

[BG] Отвертка аккумуляторна • [RO] Șurubelniță fără fir • [SR] Akumulatorski odvijač • [MK] Бижичен шрафцигер • [RU] Аккумуляторная отвертка • [SL] Akumulatorski vijačnik • [EL] Κατσαβίδι μπαταρίας • [HR] Aku odvijač • [FR] Tournevis sans fil • [IT] Avvitatore a batteria • [ES] Destornillador inalámbrico • [PT] Aparafusadora sem fio

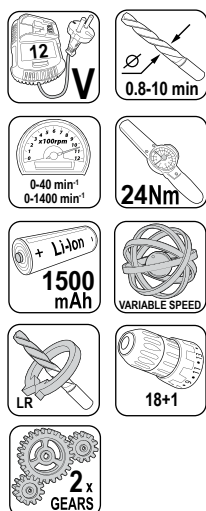

Art.No	gross weight	in cartoon	barcode
030161	2.2 kg	8 pcs	3800972019713

CORDLESS DRILL RD-CDL35

[BG] Отвертка аккумуляторна • [RO] Șurubelniță fără fir • [SR] Akumulatorski odvijač • [MK] Бижичен шрафцигер • [RU] Аккумуляторная отвертка • [SL] Akumulatorski vijačnik • [EL] Κατσαβίδι μπαταρίας • [HR] Aku odvijač • [FR] Tournevis sans fil • [IT] Avvitatore a batteria • [ES] Destornillador inalámbrico • [PT] Aparafusadora sem fio



Art.No	gross weight	in cartoon	barcode
030165	2.2 kg	8 pcs	3800972025837

CORDLESS DRILL RD-CDL34

[BG] Отвертка акумулаторна • [RO] Șurubelniță fără fir • [SR] Akumulatorski odvijač • [MK] Бeжичен шpaфцигер • [RU] Акумулаторная отвертка • [SL] Akumulatorski vijajnik • [EL] Κατσαβίδι μπαταρίας • [HR] Aku odvijač • [FR] Tournevis sans fil • [IT] Avvitatore a batteria • [ES] Destornillador inalámbrico • [PT] Aparafusadora sem fio

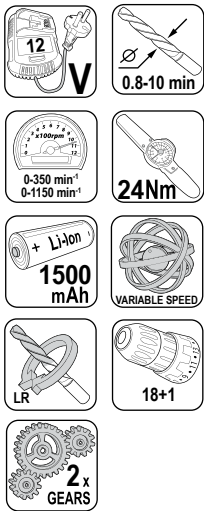

Art.No	gross weight	in cartoon	barcode
030163	2.2 kg	8 pcs	3800972022621

BATTERY FOR CORDLESS DRILL 12V 1.5AH RD-CDL33,34,35

[BG] Батерия за акумулаторна бормашина • [RO] Baterie pentru mașină de găurit fără fir • [SR] Baterija za akumulatorsku bušilicu • [MK] Батерија за бeжична дyпчaлкa • [RU] Аккумулятор для аккумуляторной дрели • [SL] Baterija za akumulatorski vrtalnik • [EL] Μπαταρία για Τρυπάνι μπαταρίας • [HR] Baterija za akumulatorsku bušilicu • [FR] Batterie pour perceuse sans fil • [IT] Batteria per trapano avvitatore a batteria • [ES] Batería para taladro inalámbrico • [PT] Bateria para furadeira sem fio



Art.No	gross weight	in cartoon	barcode
131163	-- kg	-- pcs	3800972022638

CHARGER FOR CORDLESS DRILL 12V RD-CDL33,34,35

[BG] Зарядно за акумулаторна бормашина • [RO] Încărcător pentru mașină de găurit fără fir • [SR] Punjač za akumulatorsku bušilicu • [MK] Полнач за бeжична дyпчaлкa • [RU] Зарядное устройство для аккумуляторной дрели • [SL] Polnilec za akumulatorski vrtalnik • [EL] Φορτιστής για Τρυπάνι μπαταρίας • [HR] Punjač za akumulatorsku bušilicu • [FR] Chargeur pour perceuse sans fil • [IT] Caricabatterie per trapano avvitatore a batteria • [ES] Cargador para Taladro Inalámbrico • [PT] Carregador para furadeira sem fio



Art.No	gross weight	in cartoon	barcode
032132	-- kg	-- pcs	3800972022645

CORDLESS DRILL RD-CDL27

[BG] Акумулаторна бормашина • [RO] Bormășină cu acumulator • [SR] Bušilica sa akumulatomom • [MK] Батериска бормашина • [RU] Акумулаторная дрель • [SL] Akumulatorski vrtalnik vijajnik • [EL] Τρυπάνι Μ Συσσωρευτή • [HR] Akumulatorska bušilica • [FR] Perceuse sans fil avec batterie et chargeur • [IT] Trapano senza cordone con batteria e caricabatterie • [ES] Taladro inalámbrico con batería y cargador • [PT] Aparafusadora

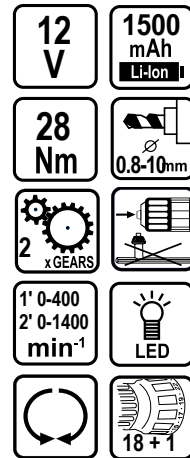

ACCESSORIES 13pcs:
• 6pcs 25mm screwdriver (PH1, PH2, PZ1, PZ2, 5, 6)
• 6pcs drill (1.5, 2.5, 3, 4, 5, 6)
• 1pc 60mm bits holder

Art.No	gross weight	in cartoon	barcode
030149	2.2 kg	8 pcs	3800972008946

CORDLESS DRILL RD-CDL09T

[BG] Акумулаторна бормашина • [RO] Bormășină cu acumulator • [SR] Bušilica sa akumulatomom • [MK] Батериска бормашина • [RU] Акумулаторная дрель • [SL] Akumulatorski vrtalnik vijajnik • [EL] Τρυπάνι Μ Συσσωρευτή • [HR] Akumulatorska bušilica • [FR] Perceuse sans fil avec batterie et chargeur • [IT] Trapano senza cordone con batteria e caricabatterie • [ES] Taladro inalámbrico con batería y cargador • [PT] Aparafusadora

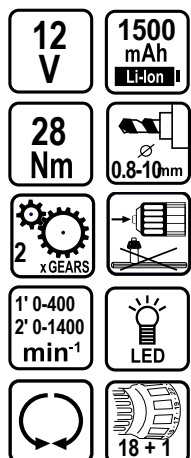

ACCESSORIES 13pcs:
• 6pcs 25mm screwdriver (PH1, PH2, PZ1, PZ2, 5, 6)
• 6pcs drill (1.5, 2.5, 3, 4, 5, 6)
• 1pc 60mm bits holder

Art.No	gross weight	in cartoon	barcode
030125	2.240 kg	8 pcs	3800123167324

CORDLESS DRILL RD-CDL26

[BG] Акумулаторна бормашина • [RO] Bormășină cu acumulator • [SR] Bušilica sa akumulatomom • [MK] Батериска бормашина • [RU] Акумулаторная дрель • [SL] Akumulatorski vrtalnik vijajnik • [EL] Τρυπάνι Μ Συσσωρευτή • [HR] Akumulatorska bušilica • [FR] Perceuse sans fil avec batterie et chargeur • [IT] Trapano senza cordone con batteria e caricabatterie • [ES] Taladro inalámbrico con batería y cargador • [PT] Aparafusadora

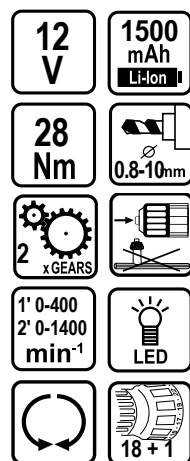

ACCESSORIES 13pcs:
• 6pcs 25mm screwdriver (PH1, PH2, PZ1, PZ2, 5, 6)
• 6pcs drill (1.5, 2.5, 3, 4, 5, 6)
• 1pc 60mm bits holder

Art.No	gross weight	in cartoon	barcode
030148	1.1 kg	8 pcs	3800872008717

RATCHET WRENCH RD-RW01

[BG] Трещотка акумулаторна в куфар с аксесоари • [RO] Cheie cu clichet • [SR] Račna sa akumulatorom • [MK] Батериска крчкалка • [RU] Аккумуляторная трещотка • [SL] Akumulatorski ratchet pisemo z dodatki • [EL] Μηχανισμός ratchet με αξεσουάρ • [HR] Akumulatorska račna • [FR] Clé à cliquet avec accessoires • [IT] chiave a cricchetto a batteria con accessori • [ES] Wrench kaj accessorioj • [PT] Aparafusadora



ACCESSORIES 8 pcs:
Adapter 3/8"-1/4" M, sockets
- 10mm, 11mm, 12mm, 13mm,
14mm, 15mm, 17mm.

Art.No	gross weight	in cartoon	barcode
030150	0.830 kg	8 pcs	3800972009875

RECIPROCATING SAW RD-RS31

[BG] Трион саблевиден акумулаторен • [RO] Fierastrau sabie cu acumulator • [SR] Klipna Testera • [MK] Батериска Враќање пила • [RU] Аккумуляторная сабельная пила • [SL] Vrtena žagai • [EL] Παλινδρομικό πριόνι • [HR] Povratna pila • [FR] Scie alternative • [IT] Sega a batteria con accessori • [ES] Reciproka seruro • [PT] Serra de vaivém

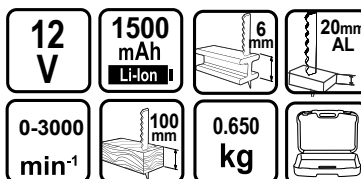

Art.No	barcode
050130	3800972015272

ADAPTER USB 12-18V

[BG] Адаптор • [RO] Adaptor • [SR] Adapter • [MK] Адаптер • [RU] Адаптер • [SL] Adapter • [EL] Προσαρμογέας • [HR] Adapter • [FR] Adaptateur • [IT] Adattatore • [ES] Adaptilo • [PT] Adaptador

12 - 18V LITHIUM-ION



Art.No	gross weight	in cartoon	barcode
032129	0.120 kg	40 pcs	3800972014497

FOR MODELS:

• RD-CDL09T • RD-CDL26 • RD-CDL27 • RD-RW01



BATTERY LI-ION

art. №	V	Ah	barcode
131154	12	1,5	3800972008755
131155	12	2	3800972009899

CHARGER

art. №	V	barcode
039705	230	3800972008748

SET CORDLESS DRILL AND HEX IMPACT DRIVER RD-CDIDL01

[BG] Комплект акумулаторни бормашина и ударен винтоверт • [RO] Kit de foraj fără fir și șurubelniță cu impact • [SR] Akumulatorska bušilica i udarni odvijач • [MK] Комплет за вежбање без кабел и шрафцигер со удари • [RU] Аккумуляторный дрель и ударная отвертка • [SL] Akumulatorski komplet vrtalnika in udarni izvijač • [EL] Ακουστικό kit και καταβίβι • [HR] Kit bežičnih bušilica i udarni odvijач • [FR] Kit de perceuse sans fil et tournevis à percussion • [IT] Kit trapano avvitatore a batteria e cacciavite a percussione • [ES] Sendrata Krančilo kaj Efika Šraūbturmilo • [PT] Kit de furadeira sem fio e chave de fenda de impacto



Art.No	gross weight	in cartoon	barcode
030158	1.580	5	3800972016507

METAL GEAR BOX



BATTERY LI-ION

Art.No	barcode
131160	3800972019430

CHARGER LI-ION

Art.No	barcode
032131	3800972019447



CORDLESS DRILL RD-CDL25

[BG] Акумулаторна бормашина • [RO] Bormașină cu acumulator • [SR] Bušilica sa akumulatorom • [MK] Батериска бормашина • [RU] Акумулаторная дрель • [SL] Akumulatorski vrtnalik vijajnik • [EL] Τρυπάνω Μ Συσσωρευτή • [HR] Akumulatorska bušilica • [FR] Perceuse sans fil avec batterie et chargeur • [IT] Trapano senza cordone con batteria e caricabatterie • [ES] Taladro inalámbrico con batería y cargador • [PT] Aparafusadora

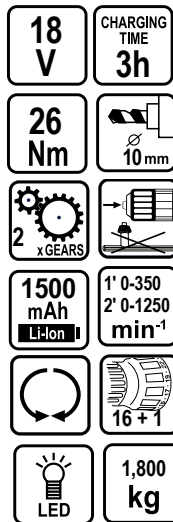

Art.No	gross weight	in cartoon	barcode
030145	1.800 kg	5 pcs	3800972005051

CORDLESS DRILL RD-CDL29

[BG] Акумулаторна бормашина • [RO] Bormașină cu acumulator • [SR] Bušilica sa akumulatorom • [MK] Батериска бормашина • [RU] Акумулаторная дрель • [SL] Akumulatorski vrtnalik vijajnik • [EL] Τρυπάνω Μ Συσσωρευτή • [HR] Akumulatorska bušilica • [FR] Perceuse sans fil avec batterie et chargeur • [IT] Trapano senza cordone con batteria e caricabatterie • [ES] Taladro inalámbrico con batería y cargador • [PT] Aparafusadora

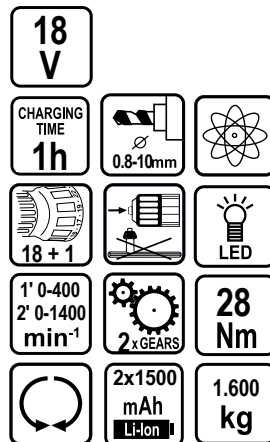

Art.No	barcode
030157	3800972016484

CORDLESS IMPACT WRENCH RD-CIWO1

[BG] Акумулаторен ударен гайковерт • [RO] Pistol de impact • [SR] Zavrtać udarni • [MK] Електронски ударен одвртувач • [RU] Импульсный гайковерт • [SL] Udarni avto vijajnik • [EL] Κρουστικό κλειδί αυτοκινήτου • [HR] Udarni odvijač • [FR] Clé à chocs • [IT] Chiave di impatto • [ES] Llave de impacto electrica • [PT] Aparafusadora de impacto

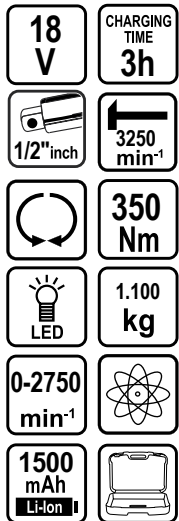

Art.No	gross weight	in cartoon	barcode
030146	1.300	5	3800972005068

CORDLESS JIG SAW RD-JSLO1

[BG] Прободен трион без батерия и зарядно • [RO] Fierastrău pendular cu acumulator • [SR] Uvodna testera • [MK] Уводна пила • [RU] Маятниковый лобзик • [SL] Nihajna vbojna žaga • [EL] Παλινδρομική σέγα • [HR] Uvodna pila • [FR] Électrique scie sauteuse • [IT] Sega • [ES] Elektra puzla • [PT] Tico-tico



Art.No	barcode
050132	3800972016514

CORDLESS CIRCULAR SAW RD-CSLO1

[BG] Циркулар акумулаторен без батерия и зарядно • [RO] Fierastrău circular • [SR] Ručni cirkular • [MK] Циркулар рачен • [RU] Дисковая пила • [SL] Krožna žaga • [EL] Δίσκς οπριο • [HR] Ručna kružna pila • [FR] Meuleuse d'angle • [IT] Sega circolar • [ES] Amoladora angular • [PT] Serra circular

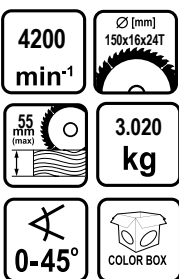

Art.No	gross weight	in cartoon	barcode
052112	3.350 kg	8 pcs	3800972016521

CORDLESS RECIPROCATING SAW RD-RSLO1

[BG] Трион саблевиден акумулаторен без батерия и зарядно • [RO] Fierastrău sabie cu acumulator • [SR] Sablja testera • [MK] Пила сабјарка • [RU] Сабельная пила • [SL] Nihajna vbojna žaga • [EL] Πριονί σέγα • [HR] Recipro pila • [FR] Scie à mouvement alternative • [IT] Sega universal • [ES] Sierra de sable • [PT] Serra sabre

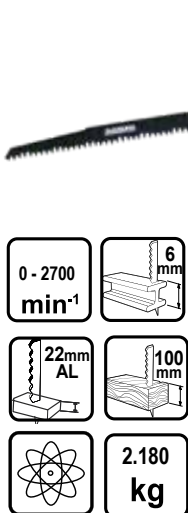

Art.No	barcode
050133	3800972016538

GRASS TRIMMER WITH BATTERY AND CHARGER RD-GTL22

• [BG] Косачка-тример с батерия и зарядно • [RO] Trimmer pentru iarba cu acumulator
 • [SR] Trimer za travu sa baterijom i punjačem • [MK] Косилка за трава са батеријом и пуњачем
 • [RU] Триммер для травы с аккумулятором и зарядным устройством • [SL] Obrezovalnik trave z baterijo in polnilnikom • [EL] Ηλεκτρικό χορτοκοπτικό • [HR] Kosilica za travu s baterijom i punjačem • [FR] Tondeuse à gazon avec batterie et chargeur • [IT] Tagliaerba con batteria e caricabatterie • [ES] Herbo tondilo kun baterio kaj šargilo • [PT] Aparador de grama com bateria e carregador

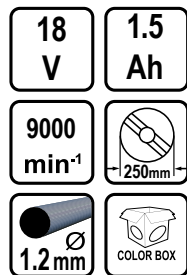

Art.No	gross weight	in cartoon	barcode
075540	3.730 kg	2 pcs	3800972005143
075528	3.500 kg	2 pcs	3800123174186
without battery and charger			

REFILL PACK WITH 10 SAFETY PLASTIC BLADES FOR CORDLESS GRASS TRIMMER RD-GTL22



Art.No	barcode
110252	3800123174353

DISC WITH 10 SAFETY PLASTIC BLADES FOR CORDLESS GRASS TRIMMER RD-GTL22



Art.No	barcode
110253	3800123174360

CORDLESS HEDGE TRIMMER WITH BATTERY AND CHARGER RD-HTL04

• [BG] Резачка за храсти с батерия и зарядно • [RO] Trimmer pt. gard viu cu acumulator
 • [SR] Bežični trimer za živu ogradu sa baterijom i punjačem • [MK] Бежичен тример со жива хец са батерија и полнач • [RU] Аккумуляторный кусторез с аккумулятором и зарядным устройством • [SL] Akumulatorski škarje za živo mejo z baterijo in polnilnikom • [EL] Ασύρματο φτερό φρένων με μπαταρία και φορτιστή • [HR] Akumulatorski trimer za živu ogradu s baterijom i punjačem • [FR] Taille-haie sans fil avec batterie et chargeur • [IT] Tagliasiepi a batteria con batteria e caricabatterie • [ES] Senkabra hegelezurilo kun baterio kaj šargilo • [PT] Corta-sebes com bateria e carregador

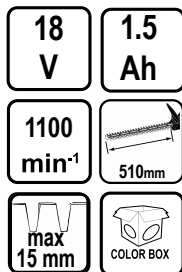

Art.No	gross weight	in cartoon	barcode
075541	3.550 kg	2 pcs	3800972005150
075704	3.300 kg	2 pcs	3800123174193
without battery and charger			

CORDLESS BLOWER VACUUM AND SHREDDER WITH BATTERY AND CHARGER RD-CBL04

• [BG] Уред за обдухване с батерия и зарядно • [RO] Trimmer pt. gard viu cu acumulator
 • [SR] Usisač lišća sa baterijom i punjačem • [MK] Всмукувач за лисја са батерија и полнач
 • [RU] Пылесос для листьев с аккумулятором и зарядным устройством • [SL] Akumulatorski sesalnik za listje • [EL] Μηχανή αναρρόφησης φύλλων • [HR] Akumulatorski usisavač / puhalo lišća • [FR] Aspirateur à feuilles avec batterie et chargeur • [IT] Aspirapolvere a foglia a batteria con batteria e caricabatterie • [ES] Folia polvosuçilo kun baterio kaj šargilo • [PT] Soprador com bateria e carregador

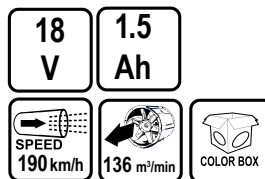

Art.No	gross weight	in cartoon	barcode
075542	2.800 kg	2 pcs	3800972005167
075530	2.290 kg	2 pcs	3800123174209
without battery and charger			

BATTERY FOR CORDLESS MACHINES LI-ION

[BG] Батерия за акумулаторни машини Li-ion • [RO] Acumulator • [SR] Baterija rezervna Li-ion
 • [MK] Батерија Li-ion • [RU] Аккумулятор Li-ion • [SL] Baterija Li-ion • [EL] Μπαταρία Li-ion για Δραπανοκοτσαφίδο • [HR] Li-ion akumulator • [FR] Batterie pour perceuse sans fil Li-ion • [IT] Batteria per batteria Li-ion • [ES] Kuirilaro por Li-ion • [PT] Bateria para Li-ion

FOR MODELS:

- RD-GTL22
- RD-HTL04
- RD-CBL04
- RD-CDL25



art. №	V	Ah	BARCODE
131143	18	1,5	3800123174339

BATTERY FOR CORDLESS MACHINES LI-ION

[BG] Батерия за акумулаторни машини Li-ion • [RO] Acumulator • [SR] Baterija rezervna Li-ion
 • [MK] Батерија Li-ion • [RU] Аккумулятор Li-ion • [SL] Baterija Li-ion • [EL] Μπαταρία Li-ion για Δραπανοκοτσαφίδο • [HR] Li-ion akumulator • [FR] Batterie pour perceuse sans fil Li-ion • [IT] Batteria per batteria Li-ion • [ES] Kuirilaro por Li-ion • [PT] Bateria para Li-ion

FOR MODELS:

- RD-GTL22
- RD-HTL04
- RD-CBL04
- RD-CDL25



art. №	V	Ah	BARCODE
131157	18	2	3800972016545

BATTERY FOR CORDLESS MACHINES LI-ION

[BG] Батерия за акумулаторни машини Li-ion • [RO] Acumulator • [SR] Baterija rezervna Li-ion • [MK] Батерија Li-ion • [RU] Аккумулятор Li-ion • [SL] Baterija Li-ion • [EL] Μπαταρία Li-ion για Δραπανοκόπτη • [HR] Li-ion akumulator • [FR] Batterie pour perceuse sans fil Li-ion • [IT] Batteria per batteria Li-ion • [ES] Kuirilaro por Li-ion • [PT] Bateria para Li-ion

FOR MODELS:

- RD-GTL22
- RD-HTL04
- RD-CBL04
- RD-CDL25



art. №	V	Ah	BARCODE
131158	18	4	3800972016552

SYSTEM STARTER KIT FOR CORDLESS MACHINES LI-ION

[BG] Комплект батерия и зарядно • [RO] Kit de pornire a sistemului pentru mașini fără fir • [SR] Sistemski starter set za bežične mašine • [MK] Систем за стартување систем за безжични машини • [RU] Системный стартовый комплект для беспроводных машин • [SL] Sistemski zaganjalni komplet za brezžične stroje • [EL] σύστημα εκκίνησης συστήματος για ασύρματα μηχανήματα • [HR] sistemski startni komplet za bežične strojeve • [FR] Kit de démarrage système pour machines sans fil • [IT] Starter kit di sistema per macchine a batteria • [ES] Sistema startigilo por sendrataj mašinoj • [PT] Kit inicial do sistema para máquinas sem fio



Art.No	V	Ah	barcode
032130	18	2	3800972016569

CHARGER FOR CORDLESS MACHINES LI-ION

[BG] Зарядно за акумулаторна бормашина Li-ion • [RO] Incarcator acumulator Li-ion • [SR] Punjač baterije Li-ion • [MK] Полнач за батерија [RU] Зарядное устройство для аккумуляторной дрели Li-ion • [SL] Polnilec baterij Li-ion • [EL] Φορτιστής μπαταρίας Li-ion • [HR] Punjač za akumulatorske bušilice Li-ion • [FR] Chargeur pour perceuse rechargeable • [IT] Caricatore per trapano ricaricabile • [ES] Chargilo por rešargebla drilo • [PT] Carregador para furadeira sem fio

18 V



3 - 5 h



Art.No	for model	V	barcode
032122	RD-GTL22, RD-HTL04, RD-CBL04	230	3800123174346

RAPID CHARGER FOR CORDLESS MACHINES LI-ION

[BG] Зарядно за акумулаторна бормашина Li-ion • [RO] Incarcator acumulator Li-ion • [SR] Punjač baterije Li-ion • [MK] Полнач за батерија [RU] Зарядное устройство для аккумуляторной дрели Li-ion • [SL] Polnilec baterij Li-ion • [EL] Φορτιστής μπαταρίας Li-ion • [HR] Punjač za akumulatorske bušilice Li-ion • [FR] Chargeur pour perceuse rechargeable • [IT] Caricatore per trapano ricaricabile • [ES] Chargilo por rešargebla drilo • [PT] Carregador para furadeira sem fio

18 V



1 h



Art.No	for model	V	barcode
032123	RD-GTL22, RD-HTL04, RD-CBL04	230	3800123174377

CORDLESS DRILL RDP-CDL21

• [BG] Акумулаторна бормашина • [RO] Bormașină cu acumulator • [SR] Bušilica sa akumulatorom • [MK] Батериска бормашина • [RU] Аккумуляторная дрель • [SL] Akumulatorski vrtnalnik vijacnik • [EL] Τρυπάνι Μ Συσσωρευτή • [HR] Akumulatorska bušilica • [FR] Perceuse sans fil avec batterie et chargeur • [IT] Trapano senza cordone con batteria e caricabatterie • [ES] Taladro inalámbrico con batería y cargador • [PT] Aparafusadora

20 V



2 BATTERIES



Art.No	gross weight	in cartoon	barcode
030207	3.300 kg	5 pcs	3800972004764

BATTERY FOR CORDLESS DRILL 20V 2AH RDP-CDL21

art. №	V	Ah	barcode
131150	20	2	3800972005082

CHARGER FOR CORDLESS DRILL LI-ION



art. №	V	barcode
039702	230	3800972004818

ECCENTRIC ADAPTOR QUICK CHANGE FOR RDP-CDL21

Art.No	barcode
139007	3800972015173

ANGLE ADAPTOR QUICK CHANGE FOR RDP-CDL21

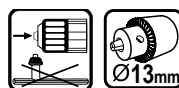
Art.No	barcode
139005	3800972014568

DRILL CHUCK FOR RDP-CDL21

Art.No	barcode
139006	3800972014572

CORDLESS GARDEN PRUNER RD-GP21 SET

[BG] Акумулаторна градинска ножица • [RO] Tunatoare de grădină fără fir • [SR] Akumulatorski vrtni rezač • [MK] Безжичен градинарски резил • [RU] Аккумуляторный садовый секатор • [SL] Akumulatorski vrtni obrezovalnik • [EL] Ασύρματο κλαδευτήρι κήπου • [HR] Akumulatorski vrtni rezač • [FR] Sécateur de jardin sans fil • [IT] Potatore da giardino a batteria • [ES] Podadora de jardín inalámbrica • [PT] Podador de jardim sem fio



Art.No	V	Ah	barcode
075720	12	2x2	3800972024281

CORDLESS GARDEN PRUNER RD-GP24 SET

[BG] Акумулаторна градинска ножица • [RO] Tunatoare de grădină fără fir • [SR] Akumulatorski vrtni rezač • [MK] Безжичен градинарски резил • [RU] Аккумуляторный садовый секатор • [SL] Akumulatorski vrtni obrezovalnik • [EL] Ασύρματο κλαδευτήρι κήπου • [HR] Akumulatorski vrtni rezač • [FR] Sécateur de jardin sans fil • [IT] Potatore da giardino a batteria • [ES] Podadora de jardín inalámbrica • [PT] Podador de jardim sem fio



Art.No	V	Ah	barcode
075726	12	2x2	3800972026742

CORDLESS ANGLE GRINDER RD-CAG72

[BG] Ъглошлайф акум • [RO] Foarfece de viță de vie fără fir • [SR] Akumulatorske makaze za lozu • [MK] Безжична ножичка за винова лоза • [RU] Аккумуляторные ножницы для винограда • [SL] Akumulatorske škarje za trto • [EL] Ασύρματο ψαλίδι αμπέλου • [HR] Akumulatorske škare za lozu • [FR] Cisailles à vigne sans fil • [IT] Forbici per vite a batteria • [ES] Tijeras para vid inalámbricas • [PT] Tesouras de videira sem fio



Art.No	V	Ah	barcode
030166	12	2	3800972027954

BATTERY 12V 2AH FOR RD-CAG72

[BG] Батерия за акумулаторни машини Li-ion • [RO] Acumulator • [SR] Baterija rezervna Li-ion • [MK] Батерија Li-ion • [RU] Аккумулятор Li-ion • [SL] Baterija Li-ion • [EL] Μπαταρία Li-ion για Δραπανοκατασβίδο • [HR] Li-ion akumulator • [FR] Batterie pour perceuse sans fil Li-ion • [IT] Batteria per batteria Li-ion • [ES] Kuirilaro por Li-ion • [PT] Bateria para Li-ion



Art.No	V	Ah	barcode
131166	12	2	3800972027961

CORDLESS BRUSHLESS PRUNING SHEARS RD-PSH01

[BG] Ножица лозарска акумулаторна • [RO] Foarfece de viță de vie fără fir • [SR] Akumulatorske makaze za lozu • [MK] Безжична ножичка за винова лоза • [RU] Аккумуляторные ножницы для винограда • [SL] Akumulatorske škarje za trto • [EL] Ασύρματο ψαλίδι αμπέλου • [HR] Akumulatorske škare za lozu • [FR] Cisailles à vigne sans fil • [IT] Forbici per vite a batteria • [ES] Tijeras para vid inalámbricas • [PT] Tesouras de videira sem fio



Art.No	V	Ah	barcode
075714	12	2	3800972016699

BATTERY PACK AND CHARGER

Art.No	V	Ah	barcode
131162	12	2	3800972020092
039710	12	2	3800972020108

CORDLESS BRUSHLESS PRUNING SHEARS RD-PSH02

[BG] Ножица лозарска акумулаторна • [RO] Foarfece de viță de vie fără fir • [SR] Akumulatorske makaze za lozu • [MK] Безжична ножичка за винова лоза • [RU] Аккумуляторные ножницы для винограда • [SL] Akumulatorske škarje za trto • [EL] Ασύρματο ψαλίδι αμπέλου • [HR] Akumulatorske škare za lozu • [FR] Cisailles à vigne sans fil • [IT] Forbici per vite a batteria • [ES] Tijeras para vid inalámbricas • [PT] Tesouras de videira sem fio

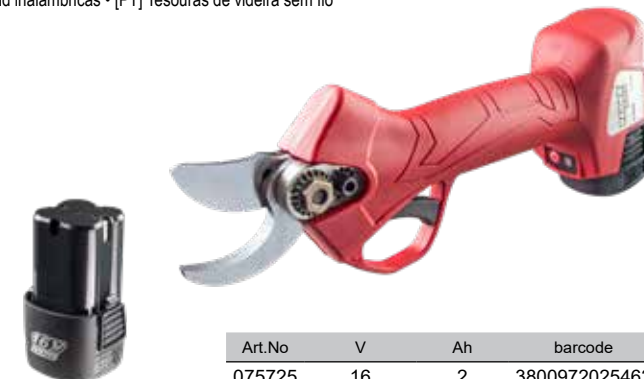

Art.No	V	Ah	barcode
075725	16	2	3800972025462

BATTERY PACK AND CHARGER

Art.No	V	Ah	barcode
131165	16	2	3800972025493
039715	16	2	3800972025509

CORDLESS GRASS AND SHRUB SHEARS RD-GSSL01

[BG] Ножица за трева и храсти акумулаторна • [RO] Foarfeca iarba si arbusti cu acumulator [SR] Akumulatorske makaze za travu i živu ogradu • [MK] Аккумуляторски ножичи за трева и жива ограда • [RU] Аккумуляторные ножницы-кусторезы • [SL] Akumulatorski škarje za živo mejo • [EL] Ψαλίδι μπουρνούρας μπαταρίας • [HR] Akumulatorske škare za travu i živicu • [FR] Cisailles à gazon et arbustes sans fil • [IT] Cesioie per erba e cesioie a batteria • [ES] Sendratraj tondiloi de herbo kaj arbusto • [PT] Corta-sebas a bateria

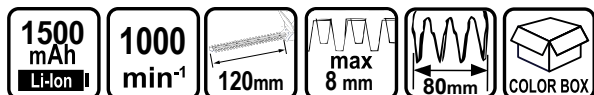

Art.No	V	weight	gross weight	in cartoon	barcode
075531 RD-GSSL01	3.6	1.200 kg	1.160 kg	10 pcs	3800123174216

CORDLESS GRASS AND SHRUB SHEARS RD-GSSL02

[BG] Ножица за трева и храсти акумулаторна • [RO] Foarfeca iarba si arbusti cu acumulator [SR] Akumulatorske makaze za travu i živu ogradu • [MK] Аккумуляторски ножичи за трева и жива ограда • [RU] Аккумуляторные ножницы-кусторезы • [SL] Akumulatorski škarje za živo mejo • [EL] Ψαλίδι μπουρνούρας μπαταρίας • [HR] Akumulatorske škare za travu i živicu • [FR] Cisailles à gazon et arbustes sans fil • [IT] Cesioie per erba e cesioie a batteria • [ES] Sendratraj tondiloi de herbo kaj arbusto • [PT] Corta-sebas a bateria

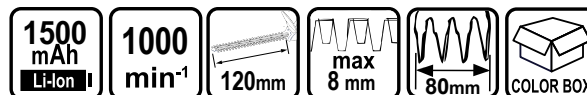

Art.No	V	weight	gross weight	in cartoon	barcode
075532 RD-GSSL02	7.2	1.400 kg	1.200 KG	10 pcs	3800123174223



RAIDER

RAIDER
PRO
100-9011 10.5 L (250W)

ELECTRIC DRILL KEYLESS CHUCK RDP-ID32

• [BG] Бормашина • [RO] Bormasina • [SR] Bušilica • [MK] Бормашина • [RU] Дрель • [SL] Vrtalnik • [EL] Κροετικό βραττάνο • [HR] Bušilica • [FR] Perceuse • [IT] Trapano • [ES] Taladro • [PT] Aparafusadora



230V~50Hz 400W 10mm

0-2900min⁻¹

VARIABLE SPEED

10mm 25mm

1.530 kg

RAIDER Pro

Art.No	gross weight	in carton	barcode
010134	1.700 kg	10 pcs	3800123165344

ELECTRIC DRILL RDP-ID43 BLACK EDITION

• [BG] Бормашина • [RO] Bormasina • [SR] Bušilica • [MK] Бормашина • [RU] Дрель • [SL] Vrtalnik • [EL] Κροετικό βραττάνο • [HR] Bušilica • [FR] Perceuse • [IT] Trapano • [ES] Taladro • [PT] Aparafusadora



BLACK EDITION

230V~50Hz 450W 10mm

0-2800min⁻¹

VARIABLE SPEED

10mm 20mm

RAIDER Pro

Art.No	gross weight	in carton	barcode
010202	1.700 kg	10 pcs	3800972015371

ELECTRIC DRILL KEYLESS CHUCK RDP-ID27

• [BG] Бормашина • [RO] Bormasina • [SR] Bušilica • [MK] Бормашина • [RU] Дрель • [SL] Vrtalnik • [EL] Κροετικό βραττάνο • [HR] Bušilica • [FR] Perceuse • [IT] Trapano • [ES] Taladro • [PT] Aparafusadora



230V~50Hz 550W 1.5-13mm

0-2800min⁻¹

VARIABLE SPEED

13mm 16mm 25mm

2.200 kg

RAIDER Pro

Art.No	gross weight	in carton	barcode
010129	2.200 kg	10 pcs	3800123162428

ELECTRIC DRILL KEYLESS CHUCK RDP-ID28

• [BG] Бормашина • [RO] Bormasina • [SR] Bušilica • [MK] Бормашина • [RU] Дрель • [SL] Vrtalnik • [EL] Κροετικό βραττάνο • [HR] Bušilica • [FR] Perceuse • [IT] Trapano • [ES] Taladro • [PT] Aparafusadora



230V~50Hz 810W 2-13mm

0-2800min⁻¹

VARIABLE SPEED

13mm 16mm 25mm

1.980 kg

RAIDER Pro

Art.No	gross weight	in carton	barcode
010130	2.200 kg	10 pcs	3800123162435

ELECTRIC IMPACT DRILL KEYLESS CHUCK RDP-ID29

• [BG] Бормашина • [RO] Bormasina • [SR] Bušilica • [MK] Бормашина • [RU] Дрель • [SL] Vrtalnik • [EL] Κροετικό βραττάνο • [HR] Bušilica • [FR] Perceuse • [IT] Trapano • [ES] Taladro • [PT] Aparafusadora



230V~50Hz 850W 1.5-13mm

0-2800min⁻¹

VARIABLE SPEED

13mm 18mm 30mm

1.980 kg

RAIDER Pro

Art.No	gross weight	in carton	barcode
010131	2.200 kg	10 pcs	3800123162442

IMPACT DRILL RDP-ID46

• [BG] Бормашина • [RO] Bormasina • [SR] Bušilica • [MK] Бормашина • [RU] Дрель • [SL] Vrtalnik • [EL] Κροετικό βραττάνο • [HR] Bušilica • [FR] Perceuse • [IT] Trapano • [ES] Taladro • [PT] Aparafusadora



230V~50Hz 900W 1.5-13mm

0-2800min⁻¹

VARIABLE SPEED

13mm 18mm 30mm

1.980 kg

RAIDER Pro

Art.No	gross weight	in carton	barcode
010203	2.200 kg	10 pcs	3800972026872

ELECTRIC DRILL RDP-ID43 BLACK EDITION

• [BG] Бормашина • [RO] Bormasina • [SR] Bušilica • [MK] Бормашина • [RU] Дрель • [SL] Vrtalnik • [EL] Κρουστικό βρταπνο • [HR] Bušilica • [FR] Perceuse • [IT] Trapano • [ES] Taladro • [PT] Aparafusadora

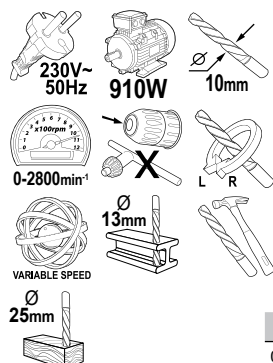

Art.No	gross weight	in carton	barcode
010201	1.700 kg	10 pcs	3800972015364

ELECTRIC IMPACT DRILL KEYLESS CHUCK RDP-ID31

• [BG] Бормашина • [RO] Bormasina • [SR] Bušilica • [MK] Бормашина • [RU] Дрель • [SL] Vrtalnik • [EL] Κρουστικό βρταпно • [HR] Bušilica • [FR] Perceuse • [IT] Trapano • [ES] Taladro • [PT] Aparafusadora

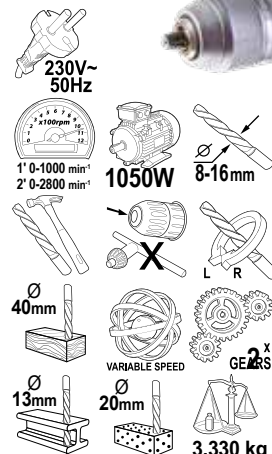

Art.No	gross weight	in carton	barcode
010133	3.700 kg	5 pcs	3800123163586



ELECTRIC IMPACT DRILL KEYLESS CHUCK RD-ID40

• [BG] Бормашина • [RO] Bormasina • [SR] Bušilica • [MK] Бормашина • [RU] Дрель • [SL] Vrtalnik • [EL] Κρουστικό βρταпно • [HR] Bušilica • [FR] Perceuse • [IT] Trapano • [ES] Taladro • [PT] Aparafusadora

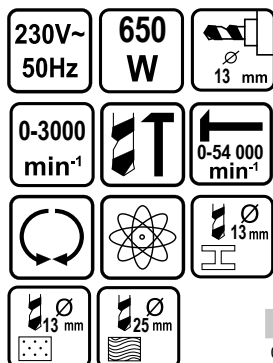

Art.No	gross weight	in carton	barcode
010140	1.9 kg	10	3800972005471

ELECTRIC IMPACT DRILL RD-ID41

• [BG] Бормашина • [RO] Bormasina • [SR] Bušilica • [MK] Бормашина • [RU] Дрель • [SL] Vrtalnik • [EL] Κρουστικό βρταпно • [HR] Bušilica • [FR] Perceuse • [IT] Trapano • [ES] Taladro • [PT] Aparafusadora

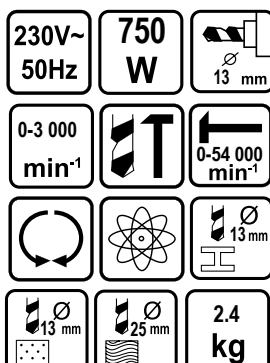

Art.No	gross weight	in carton	barcode
010141	2.4 kg	10	3800972008694

IMPACT DRILL RD-ID45

• [BG] Бормашина • [RO] Bormasina • [SR] Bušilica • [MK] Бормашина • [RU] Дрель • [SL] Vrtalnik • [EL] Κρουστικό βρταпно • [HR] Bušilica • [FR] Perceuse • [IT] Trapano • [ES] Taladro • [PT] Aparafusadora

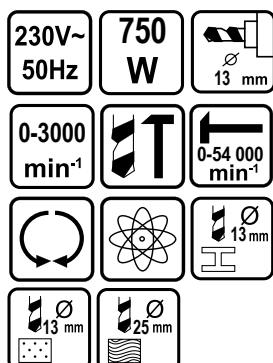

Art.No	gross weight	in carton	barcode
010145	1.9 kg	10	3800972026865

ELECTRIC IMPACT DRILL RD-ID36

• [BG] Бормашина • [RO] Bormasina • [SR] Bušilica • [MK] Бормашина • [RU] Дрель • [SL] Vrtalnik • [EL] Κρουστικό βρταпно • [HR] Bušilica • [FR] Perceuse • [IT] Trapano • [ES] Taladro • [PT] Aparafusadora

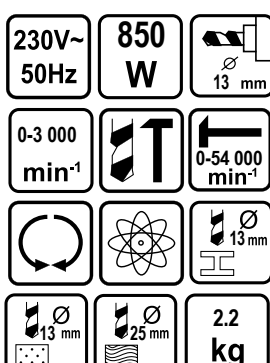

Art.No	gross weight	in carton	barcode
010139	2.4 kg	10	3800972001183

IMPACT DRILL 1050W 13MM RD-ID44

[BG] Бормашина • [RO] Bormasina • [SR] Bušilica • [MK] Бормашина • [RU] Дрель • [SL] Vrtalni nik • [EL] Κροουτίκο βρτάνο • [HR] Bušilica • [FR] Perceuse • [IT] Trapano • [ES] Taladro • [PT] Aparafusadora

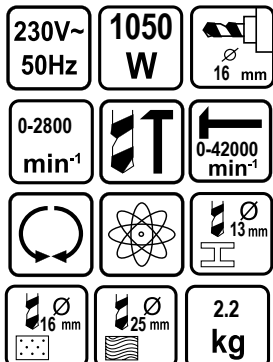

Art.No	gross weight	in cartoon	barcode
010142	2.4 kg	10	3800972018891

BENCH DRILL RDP-BD04

[BG] Настолна бормашина • [RO] Masina de gaurit fixa • [SR] Bušilica stubna • [MK] Бормашина • [RU] Настольно-сверильный станок [SL] Namizni vrtalni stroj • [EL] Κροουτίκο Δράπανο • [HR] Stupna bušilica • [FR] Perceuse d'établi • [IT] Trapano da banco • [ES] Benka trilo • [PT] Berbequim vertical

RAIDER Pro SPINDLE TAPER: B16 SPINDLE SPEED

580 min⁻¹
850 min⁻¹
1220 min⁻¹
1650 min⁻¹
2650 min⁻¹



Art.No	gross weight	in cartoon	barcode
011104	14 kg	1	3800123108693

BENCH DRILL RDP-BD05

[BG] Настолна бормашина • [RO] Masina de gaurit fixa • [SR] Bušilica stubna • [MK] Бормашина • [RU] Настольно-сверильный станок [SL] Namizni vrtalni stroj • [EL] Κροουτίκο Δράπανο • [HR] Stupna bušilica • [FR] Perceuse d'établi • [IT] Trapano da banco • [ES] Benka trilo • [PT] Berbequim vertical

RAIDER Pro SPINDLE TAPER: B16 SPINDLE SPEED

220 min⁻¹
330 min⁻¹
350 min⁻¹
450 min⁻¹
520 min⁻¹
560 min⁻¹
1050 min⁻¹
1130 min⁻¹
1300 min⁻¹
1630 min⁻¹
1800 min⁻¹
2450 min⁻¹

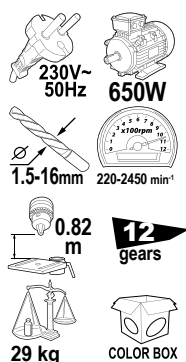

Art.No	gross weight	in cartoon	barcode
011105	31 kg	1	3800972018457

BENCH DRILL RDP-BD02

[BG] Настолна бормашина • [RO] Masina de gaurit fixa • [SR] Bušilica stubna • [MK] Бормашина • [RU] Настольно-сверильный станок [SL] Namizni vrtalni stroj • [EL] Κροουτίκο Δράπανο • [HR] Stupna bušilica • [FR] Perceuse d'établi • [IT] Trapano da banco • [ES] Benka trilo • [PT] Berbequim vertical

RAIDER Pro SPINDLE TAPER: MT2 SPINDLE SPEED

210 min⁻¹
300 min⁻¹
350 min⁻¹
450 min⁻¹
500 min⁻¹
540 min⁻¹
970 min⁻¹
1040 min⁻¹
1170 min⁻¹
1480 min⁻¹
1580 min⁻¹
2220 min⁻¹

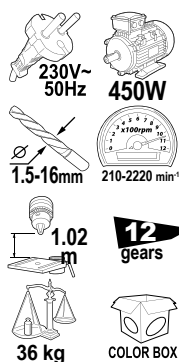

Art.No	gross weight	in cartoon	barcode
011102	38 kg	1	3800123123122

BENCH DRILL RDP-BD03

[BG] Настолна бормашина • [RO] Masina de gaurit fixa • [SR] Bušilica stubna • [MK] Бормашина • [RU] Настольно-сверильный станок [SL] Namizni vrtalni stroj • [EL] Κροουτίκο Δράπανο • [HR] Stupna bušilica • [FR] Perceuse d'établi • [IT] Trapano da banco • [ES] Benka trilo • [PT] Berbequim vertical

RAIDER Pro SPINDLE TAPER: B16 SPINDLE SPEED

270 min⁻¹
360 min⁻¹
490 min⁻¹
560 min⁻¹
590 min⁻¹
970 min⁻¹
1100 min⁻¹
1250 min⁻¹
1350 min⁻¹
1620 min⁻¹
2120 min⁻¹
2800 min⁻¹

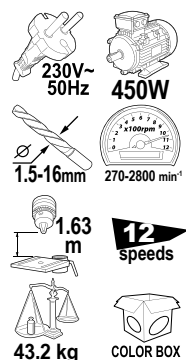

Art.No	gross weight	in cartoon	barcode
011103	48 kg	1	3800123124860

DRAYWALL SCREWDRIVER RD-CDD04

[BG] Винтоверт • [RO] Surubelnita electrica • [SR] Električni Odvijač • [MK] Штрафилица • [RU] Электрическая отвёртка • [SL] Izvijajč zavijake zagips plošče • [EL] Ηλεκτρικό κατσαβίδι για γυψοσανίδες • [HR] Odvijač • [FR] Tournevis à cloisons sèches • [IT] Cacciavite per cartongesso • [ES] Desengnilo drywall • [PT] Aparafusadora p/ gesso cartonado

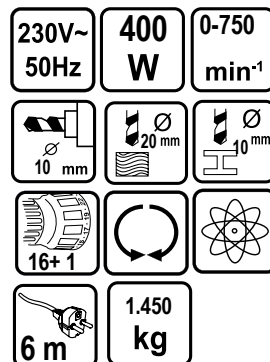

Art.No	gross weight	in cartoon	barcode
073105	1.650 kg	10 pcs	3800972004221

DRAYWALL SCREWDRIVER RD-CDD08

[BG] Винтоверт • [RO] Surubelnita electrica • [SR] Električni Odvijač • [MK] Штрафилица • [RU] Электрическая отвёртка • [SL] Izvijač zavijake zagips plošče • [EL] Ηλεκτρικό κατσαβίδι για γυψοσανίδες • [HR] Odvijač • [FR] Tournevis à cloisons sèches • [IT] Cacciavite per cartongesso • [ES] Desegnilo drywall • [PT] Aparafusadora p/ gesso cartonado

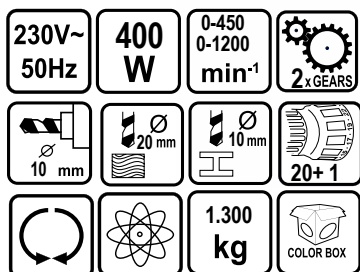

Art.No	barcode
073109	3800972016453

DRAYWALL SCREWDRIVER RD-CDD07

[BG] Винтоверт • [RO] Surubelnita electrica • [SR] Električni Odvijač • [MK] Штрафилица • [RU] Электрическая отвёртка • [SL] Izvijač zavijake zagips plošče • [EL] Ηλεκτρικό κατσαβίδι για γυψοσανίδες • [HR] Odvijač • [FR] Tournevis à cloisons sèches • [IT] Cacciavite per cartongesso • [ES] Desegnilo drywall • [PT] Aparafusadora p/ gesso cartonado

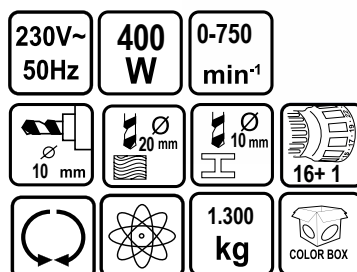

Art.No	barcode
073108	3800972016446

DRAYWALL SCREWDRIVER RDP-CDD02

[BG] Винтоверт • [RO] Surubelnita electrica • [SR] Električni Odvijač • [MK] Штрафилица • [RU] Электрическая отвёртка • [SL] Izvijač zavijake zagips plošče • [EL] Ηλεκτρικό κατσαβίδι για γυψοσανίδες • [HR] Odvijač • [FR] Tournevis à cloisons sèches • [IT] Cacciavite per cartongesso • [ES] Desegnilo drywall • [PT] Aparafusadora p/ gesso cartonado

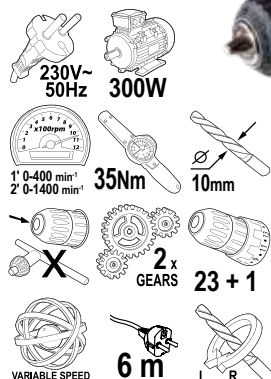

Art.No	gross weight	in cartoon	barcode
073103	1.800 kg	5 pcs	3800123166075

DRAYWALL SCREWDRIVER RDP-CDD06

[BG] Винтоверт • [RO] Surubelnita electrica • [SR] Električni Odvijač • [MK] Штрафилица • [RU] Электрическая отвёртка • [SL] Izvijač zavijake zagips plošče • [EL] Ηλεκτρικό κατσαβίδι για γυψοσανίδες • [HR] Odvijač • [FR] Tournevis à cloisons sèches • [IT] Cacciavite per cartongesso • [ES] Desegnilo drywall • [PT] Aparafusadora p/ gesso cartonado

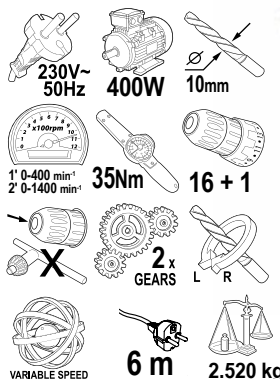

Art.No	barcode
073301	3800972016439

DRAYWALL SCREWDRIVER RD-CDD03

[BG] Винтоверт • [RO] Surubelnita electrica • [SR] Električni Odvijač • [MK] Штрафилица • [RU] Электрическая отвёртка • [SL] Izvijač zavijake zagips plošče • [EL] Ηλεκτρικό κατσαβίδι για γυψοσανίδες • [HR] Odvijač • [FR] Tournevis à cloisons sèches • [IT] Cacciavite per cartongesso • [ES] Desegnilo drywall • [PT] Aparafusadora p/ gesso cartonado

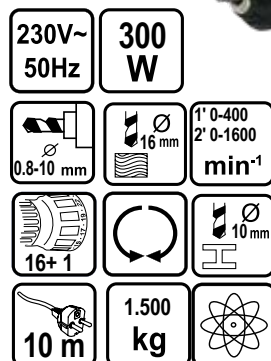

Art.No	gross weight	in cartoon	barcode
073104	1.700 kg	5 pcs	3800123167539

CORDED DRILL DRIVER RDP-CDD09

[BG] Винтоверт • [RO] Surubelnita electrica • [SR] Električni Odvijač • [MK] Штрафилица • [RU] Электрическая отвёртка • [SL] Izvijač zavijake zagips plošče • [EL] Ηλεκτρικό κατσαβίδι για γυψοσανίδες • [HR] Odvijač • [FR] Tournevis à cloisons sèches • [IT] Cacciavite per cartongesso • [ES] Desegnilo drywall • [PT] Aparafusadora p/ gesso cartonado

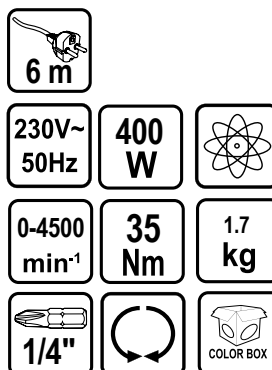

Art.No	gross weight	in cartoon	barcode
073302	2.400 kg	5 pcs	3800972023659

DRAYWALL SCREWDRIVER RD-ES46

[BG] Винтоверт • [RO] Surubelnita electrica • [SR] Električni Otvijač • [MK] Штрафилица • [RU] Электрическая отвёртка • [SL] Izvijač zavijake zagips plošče • [EL] Ηλεκτρικό κατσαβίδι για γυψοσανίδες • [HR] Otvijač • [FR] Tournevis à cloisons sèches • [IT] Cacciavite per cartongesso • [ES] Desegnilo drywall • [PT] Aparafusadora p/ gesso cartonado



230V~ 50Hz	520 W	
0-4500 min ⁻¹	10 Nm	1.7 kg
 1/4"		 COLOR BOX

Art.No	gross weight	in cartoon	barcode
073101	1.900 kg	5 pcs	3800123163616

DRAYWALL SCREWDRIVER RD-ES47

[BG] Винтоверт • [RO] Surubelnita electrica • [SR] Električni Otvijač • [MK] Штрафилица • [RU] Электрическая отвёртка • [SL] Izvijač zavijake zagips plošče • [EL] Ηλεκτρικό κατσαβίδι για γυψοσανίδες • [HR] Otvijač • [FR] Tournevis à cloisons sèches • [IT] Cacciavite per cartongesso • [ES] Desegnilo drywall • [PT] Aparafusadora p/ gesso cartonado



230V~ 50Hz	710 W	
0-4000 min ⁻¹	10 Nm	1.8 kg
 1/4"		

Art.No	gross weight	in cartoon	barcode
073107	2.000 kg	10 pcs	3800972010642

IMPACT WRENCH RD-EIW07

[BG] Гайковерт ударен • [RO] Pistol de impact • [SR] Zavrtáč udarni • [MK] Електронски ударен одвртвач • [RU] Импульсный гайковерт • [SL] Udarni avto vijačnik • [EL] Κρουστικό κλειδί αυτοκινήτου • [HR] Udarni odvijač • [FR] Clé à chocs • [IT] Chiave di impatto • [ES] Llave de impacto • [PT] Chave de impacto



230V~ 50Hz	450 W	
0-3000 min ⁻¹	350 Nm	2.9 kg
 1/2" inch		

ACCESSORIES 4pcs:
Sockets 17,19,21,22 mm



Art.No	gross weight	in cartoon	barcode
073206	3.120 kg	5 pcs	3800972016385

IMPACT WRENCH RD-EIW08

[BG] Гайковерт ударен • [RO] Pistol de impact • [SR] Zavrtáč udarni • [MK] Електронски ударен одвртвач • [RU] Импульсный гайковерт • [SL] Udarni avto vijačnik • [EL] Κρουστικό κλειδί αυτοκινήτου • [HR] Udarni odvijač • [FR] Clé à chocs • [IT] Chiave di impatto • [ES] Llave de impacto • [PT] Chave de impacto



230V~ 50Hz	950 W	
0-3000 min ⁻¹	500 Nm	2.9 kg
 1/2" inch		

Art.No	gross weight	in cartoon	barcode
073208	3.120 kg	5 pcs	3800972026537

IMPACT WRENCH RD-EIW04

[BG] Гайковерт ударен • [RO] Pistol de impact • [SR] Zavrtáč udarni • [MK] Електронски ударен одвртвач • [RU] Импульсный гайковерт • [SL] Udarni avto vijačnik • [EL] Κρουστικό κλειδί αυτοκινήτου • [HR] Udarni odvijač • [FR] Clé à chocs • [IT] Chiave di impatto • [ES] Llave de impacto • [PT] Chave de impacto



230V~ 50Hz	1100 W	
2200 min ⁻¹	450 Nm	4.3 kg
 1/2" inch		

Art.No	gross weight	in cartoon	barcode
073203	4.800 kg	5 pcs	3800972002555

IMPACT WRENCH RD-EIW05

[BG] Гайковерт ударен • [RO] Pistol de impact • [SR] Zavrtáč udarni • [MK] Електронски ударен одвртвач • [RU] Импульсный гайковерт • [SL] Udarni avto vijačnik • [EL] Κρουστικό κλειδί αυτοκινήτου • [HR] Udarni odvijač • [FR] Clé à chocs • [IT] Chiave di impatto • [ES] Llave de impacto • [PT] Chave de impacto



230V~ 50Hz	1050 W	
2200 min ⁻¹	500 Nm	5.3 kg
 1/2" inch		

Art.No	gross weight	in cartoon	barcode
073204	5.900 kg	4 pcs	3800972002562

ROTARY HAMMER RD-HD53

[BG] Перфоратор • [RO] Ciocan rotopercutor • [SR] Čekić bušilica • [MK] Ударен чекан
 • [RU] Перфоратор • [SL] Rotacijski udarni vrtnik • [EL] Περιστροφικό δρασπανο με σφύρι
 • [HR] Čekić udarni • [FR] Marteau rotatif • [IT] Martello rotante • [ES] Rotaj hammer • [PT] Martelo perfurador

230V~ 50Hz	620 W
4850 min ⁻¹	2.0 J
13mm	24mm
2 functions	SDS+
0-1000 min ⁻¹	30mm



Art.No	gross weight	in cartoon	barcode
013135	3.330 kg	5 pcs	3800972009189

ROTARY HAMMER RD-HD54

[BG] Перфоратор • [RO] Ciocan rotopercutor • [SR] Čekić bušilica • [MK] Ударен чекан
 • [RU] Перфоратор • [SL] Rotacijski udarni vrtnik • [EL] Περιστροφικό δρασπανο με σφύρι
 • [HR] Čekić udarni • [FR] Marteau rotatif • [IT] Martello rotante • [ES] Rotaj hammer • [PT] Martelo perfurador

230V~ 50Hz	750 W
4850 min ⁻¹	2.2 J
13mm	30mm
4 functions	SDS+
0-1000 min ⁻¹	26mm



Art.No	gross weight	in cartoon	barcode
013136	4.070 kg	5 pcs	3800972009196

ROTARY HAMMER RD-HD40

[BG] Перфоратор • [RO] Ciocan rotopercutor • [SR] Čekić bušilica • [MK] Ударен чекан
 • [RU] Перфоратор • [SL] Rotacijski udarni vrtnik • [EL] Περιστροφικό δρασπανο με σφύρι
 • [HR] Čekić udarni • [FR] Marteau rotatif • [IT] Martello rotante • [ES] Rotaj hammer • [PT] Martelo perfurador

230V~ 50Hz	800 W
4850 min ⁻¹	2.2 J
13mm	26mm
4 functions	SDS+
0-1000 min ⁻¹	30mm



ACCESSORIES:
 3 drill bits (Ø6 / 8 / 10 x 150mm)
 1pc flat chisel (14 x 250mm)
 1pc point chisel (14 x 250mm)
 1pc depth ruler

Art.No	gross weight	in cartoon	barcode
012104	5.300 kg	2 pcs	3800123173431

ROTARY HAMMER RD-HD38

[BG] Перфоратор • [RO] Ciocan rotopercutor • [SR] Čekić bušilica • [MK] Ударен чекан
 • [RU] Перфоратор • [SL] Rotacijski udarni vrtnik • [EL] Περιστροφικό δρασπανο με σφύρι
 • [HR] Čekić udarni • [FR] Marteau rotatif • [IT] Martello rotante • [ES] Rotaj hammer • [PT] Martelo perfurador

230V~ 50Hz	800 W
5000 min ⁻¹	2.5 J
13mm	26mm
4 functions	SDS+
0-930 min ⁻¹	30mm



ACCESSORIES:
 3 drill bits (Ø6 / 8 / 10 x 150mm)
 1pc flat chisel (14 x 250mm)
 1pc point chisel (14 x 250mm)
 1pc depth ruler

Art.No	gross weight	in cartoon	barcode
013126	5.660 kg	2 pcs	3800123167003

ROTARY HAMMER RD-HD51

[BG] Перфоратор • [RO] Ciocan rotopercutor • [SR] Čekić bušilica • [MK] Ударен чекан
 • [RU] Перфоратор • [SL] Rotacijski udarni vrtnik • [EL] Περιστροφικό δρασπανο με σφύρι
 • [HR] Čekić udarni • [FR] Marteau rotatif • [IT] Martello rotante • [ES] Rotaj hammer • [PT] Martelo perfurador

230V~ 50Hz	1050 W
5000 min ⁻¹	3.4 J
13mm	32mm
4 functions	SDS+
0-900 min ⁻¹	30mm



Art.No	gross weight	in cartoon	barcode
012105	3.800 kg	2 pcs	3800972008434

ROTARY HAMMER RDP-HD05S

[BG] Перфоратор • [RO] Ciocan rotopercutor • [SR] Čekić bušilica • [MK] Ударен чекан
 • [RU] Перфоратор • [SL] Rotacijski udarni vrtnik • [EL] Περιστροφικό δρασπανο με σφύρι
 • [HR] Čekić udarni • [FR] Marteau rotatif • [IT] Martello rotante • [ES] Rotaj hammer • [PT] Martelo perfurador

230V~ 50Hz	750W
2.6J	
0-4850 min ⁻¹	
30mm	26mm
L R	VARIABLE SPEED
0-980 min ⁻¹	13mm



SDS+

**RAIDER®
Pro**

Art.No	gross weight	in cartoon	barcode
012101	4 kg	3 pcs	3800123124785

ROTARY HAMMER RDP-HD12H

[BG] Перфоратор • [RO] Ciocan rotoperculator • [SR] Čekić bušilica • [MK] Ударен чекан
 • [RU] Перфоратор • [SL] Rotacijski udarni vrtnalnik • [EL] Περιστροφικό δρασπανο με σφύρι
 • [HR] Čekić udarni • [FR] Marteau rotatif • [IT] Martello rotante • [ES] Rotaj hammer • [PT] Martelo perforador

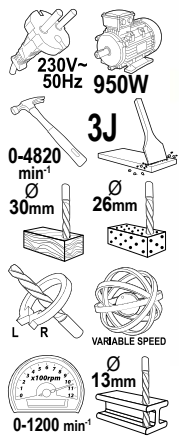

Art.No	gross weight	in cartoon	barcode
012103	4.200 kg	3 pcs	3800123153884

ROTARY HAMMER RD-HD52

[BG] Перфоратор • [RO] Ciocan rotoperculator • [SR] Čekić bušilica • [MK] Ударен чекан
 • [RU] Перфоратор • [SL] Rotacijski udarni vrtnalnik • [EL] Περιστροφικό δρασπανο με σφύρι
 • [HR] Čekić udarni • [FR] Marteau rotatif • [IT] Martello rotante • [ES] Rotaj hammer • [PT] Martelo perforador

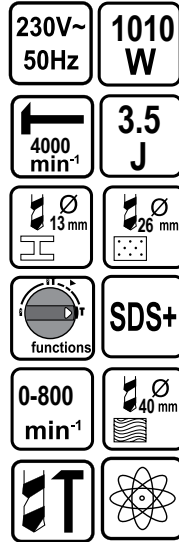

ACCESSORIES:
 3 drill bits (Ø8/10/12 x 150mm)
 1pc flat chisel
 1pc point chisel (Ø14 x 250mm)
 1bottle grease
 1pc dust cover
 1pc depth ruler

Art.No	gross weight	in cartoon	barcode
013134	6.330 kg	3 pcs	3800972008915

ROTARY HAMMER RD-HD04

[BG] Перфоратор • [RO] Ciocan rotoperculator • [SR] Čekić bušilica • [MK] Ударен чекан
 • [RU] Перфоратор • [SL] Rotacijski udarni vrtnalnik • [EL] Περιστροφικό δρασπανο με σφύρι
 • [HR] Čekić udarni • [FR] Marteau rotatif • [IT] Martello rotante • [ES] Rotaj hammer • [PT] Martelo perforador

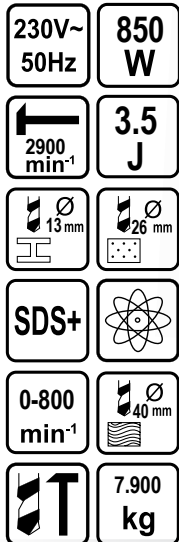

ACCESSORIES:
 SDS+ 08x150 mm drill bit
 SDS+ 10x150 mm drill bit
 SDS+ 12x150 mm drill bit
 SDS+ 14x250 mm flat chisel
 SDS+ 14x250 mm pointed chisel

Art.No	gross weight	in cartoon	barcode
013111	8.200 kg	2 pcs	3800123160837

ROTARY HAMMER RD-HD37

[BG] Перфоратор • [RO] Ciocan rotoperculator • [SR] Čekić bušilica • [MK] Ударен чекан
 • [RU] Перфоратор • [SL] Rotacijski udarni vrtnalnik • [EL] Περιστροφικό δρασπανο με σφύρι
 • [HR] Čekić udarni • [FR] Marteau rotatif • [IT] Martello rotante • [ES] Rotaj hammer • [PT] Martelo perforador

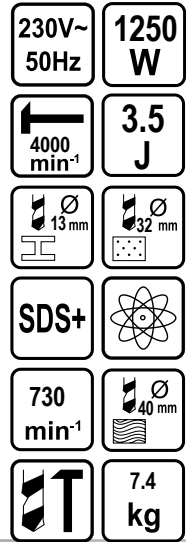

ACCESSORIES:
 3 drill bits (Ø8/10/12 x 150mm)
 1pc flat chisel
 1pc point chisel (Ø14 x 250mm)
 1bottle grease
 1pc dust cover
 1pc depth ruler

Art.No	gross weight	in cartoon	barcode
013125	8.200 kg	2 pcs	3800123167027

ROTARY HAMMER RD-HD46

[BG] Перфоратор • [RO] Ciocan rotoperculator • [SR] Čekić bušilica • [MK] Ударен чекан
 • [RU] Перфоратор • [SL] Rotacijski udarni vrtnalnik • [EL] Περιστροφικό δρασπανο με σφύρι
 • [HR] Čekić udarni • [FR] Marteau rotatif • [IT] Martello rotante • [ES] Rotaj hammer • [PT] Martelo perforador

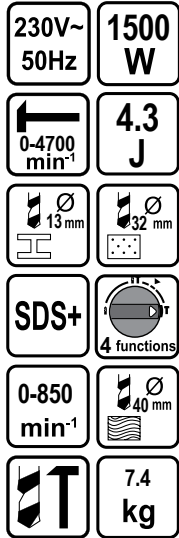

ACCESSORIES:
 SDS+ 6x150 mm drill bit
 SDS+ 8x150 mm drill bit
 SDS+ 10x150 mm drill bit
 SDS+ 14x250 mm flat chisel
 SDS+ 14x250 mm pointed chisel

Art.No	gross weight	in cartoon	barcode
013132	8.260 kg	2 pcs	3800123174841

ROTARY HAMMER RD-HD47

[BG] Перфоратор • [RO] Ciocan rotoperculator • [SR] Čekić bušilica • [MK] Ударен чекан
 • [RU] Перфоратор • [SL] Rotacijski udarni vrtnalnik • [EL] Περιστροφικό δρασπανο με σφύρι
 • [HR] Čekić udarni • [FR] Marteau rotatif • [IT] Martello rotante • [ES] Rotaj hammer • [PT] Martelo perforador

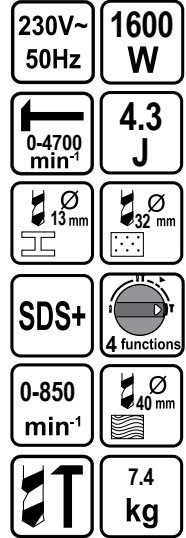

ACCESSORIES:
 3 drill bits (Ø6 / 8 / 10 x 150mm)
 1pc flat chisel (Ø14 x 250mm)
 1pc point chisel (Ø14 x 250mm)

Art.No	gross weight	in cartoon	barcode
013133	8.250 kg	2 pcs	3800972001503

ROTARY HAMMER RDP-HD35

[BG] Перфоратор • [RO] Ciocan rotopercutor • [SR] Čekić bušilica • [MK] Ударен чекан
 • [RU] Перфоратор • [SL] Rotacijski udarni vrtalnik • [EL] Περιστροφικό δρασπανο με σφυρι
 • [HR] Čekić udarni • [FR] Marteau rotatif • [IT] Martello rotante • [ES] Rotaj hammer • [PT] Martelo perforador

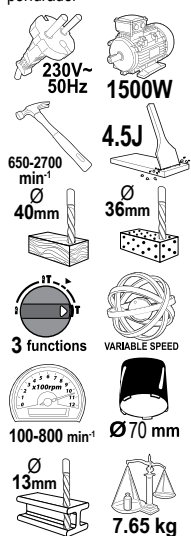

Art.No	gross weight	in cartoon	barcode
013123	8.500 kg	2 pcs	3800123165603

ROTARY HAMMER RDP-HD57

[BG] Перфоратор • [RO] Ciocan rotopercutor • [SR] Čekić bušilica • [MK] Ударен чекан
 • [RU] Перфоратор • [SL] Rotacijski udarni vrtalnik • [EL] Περιστροφικό δρασπανο με σφυρι
 • [HR] Čekić udarni • [FR] Marteau rotatif • [IT] Martello rotante • [ES] Rotaj hammer • [PT] Martelo perforador

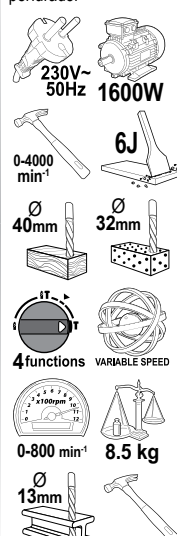

Art.No	gross weight	in cartoon	barcode
012203	9.000 kg	2 pcs	3800972016460

ROTARY HAMMER RDP-HD56

[BG] Перфоратор • [RO] Ciocan rotopercutor • [SR] Čekić bušilica • [MK] Ударен чекан
 • [RU] Перфоратор • [SL] Rotacijski udarni vrtalnik • [EL] Περιστροφικό δρασπανο με σφυρι
 • [HR] Čekić udarni • [FR] Marteau rotatif • [IT] Martello rotante • [ES] Rotaj hammer • [PT] Martelo perforador

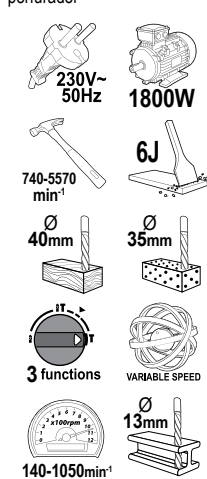

Art.No	barcode
012202	3800972016187

ROTARY HAMMER RDP-HD31

[BG] Перфоратор • [RO] Ciocan rotopercutor • [SR] Čekić bušilica • [MK] Ударен чекан
 • [RU] Перфоратор • [SL] Rotacijski udarni vrtalnik • [EL] Περιστροφικό δρασπανο με σφυρι
 • [HR] Čekić udarni • [FR] Marteau rotatif • [IT] Martello rotante • [ES] Rotaj hammer • [PT] Martelo perforador

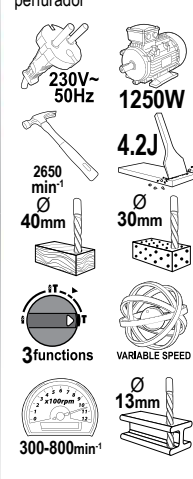

Art.No	gross weight	in cartoon	barcode
013112	9.100 kg	2 pcs	3800123160844

ROTARY HAMMER RDP-HD30

[BG] Перфоратор • [RO] Ciocan rotopercutor • [SR] Čekić bušilica • [MK] Ударен чекан
 • [RU] Перфоратор • [SL] Rotacijski udarni vrtalnik • [EL] Περιστροφικό δρασπανο με σφυρι
 • [HR] Čekić udarni • [FR] Marteau rotatif • [IT] Martello rotante • [ES] Rotaj hammer • [PT] Martelo perforador

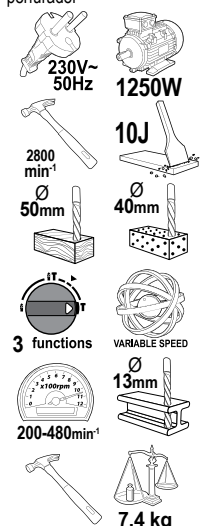

Art.No	gross weight	in cartoon	barcode
013201	8.4	2 pcs	3800123158575

ROTARY HAMMER RDP-HD55

[BG] Перфоратор • [RO] Ciocan rotopercutor • [SR] Čekić bušilica • [MK] Ударен чекан
 • [RU] Перфоратор • [SL] Rotacijski udarni vrtalnik • [EL] Περιστροφικό δρασπανο με σφυρι
 • [HR] Čekić udarni • [FR] Marteau rotatif • [IT] Martello rotante • [ES] Rotaj hammer • [PT] Martelo perforador

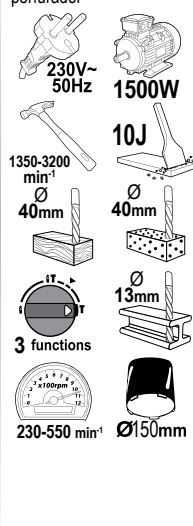

Art.No	gross weight	in cartoon	barcode
013202	11.250 kg	2 pcs	3800972009622

UNIVERSAL DUST EXTRACTOR MAX DRILL SDS Ø17/Ø70 MM WITH HOSE VACUUM ADAPTOR

DUST COLLECTOR FOR IMPACT DRILL Ø10



Art.No	barcode
499801	3800972001497



Art.No	barcode
138001	3800972023727
138002	3800972023734

DEMOLITION HAMMER RDP-DH03

[BG] Къртач • [RO] Ciocan rotopercutor • [SR] Čekić bušilica • [MK] Ударен чекач
• [RU] Перфоратор • [SL] Rotacijski udarni vrtalnik • [EL] Περιστροφικό δρασπανο με σφύρι
• [HR] Čekić udarni • [FR] Marteau rotatif • [IT] Martello rotante • [ES] Rotaj hammer
• [PT] Martelo perfurador

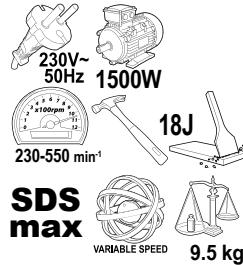

RAIDER[®]
Pro

Art.No	gross weight	in cartoon	barcode
012204	10.00 kg	2 pcs	3800972016477

DEMOLITION HAMMER RD-DH02

[BG] Къртач • [RO] Ciocan rotopercutor • [SR] Čekić bušilica • [MK] Ударен чекач
• [RU] Перфоратор • [SL] Rotacijski udarni vrtalnik • [EL] Περιστροφικό δρασπανο με σφύρι
• [HR] Čekić udarni • [FR] Marteau rotatif • [IT] Martello rotante • [ES] Rotaj hammer
• [PT] Martelo perfurador

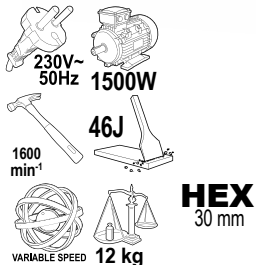

Art.No	barcode
013137	3800972016347

ANGLE GRINDER HANDLE 115 И 125 MM



Art.No	barcode
139502	3800972014923

ANGLE GRINDER RDP-AG68

[BG] Ъглошлайф • [RO] Polizor unghiular • [SR] Brusilica ugaona • [MK] Брусилка • [RU] Угловая
шлифовальная машина • [SL] Kotni brusilnik • [EL] ΓΩΝΙΑΚΟΣ ΤΡΟΧΟΣ • [HR] Kutna brusilica
• [FR] Meuleuse à angle • [IT] Smerigliatrice angolare • [ES] Angulo muelillo • [PT] Rebarbadora

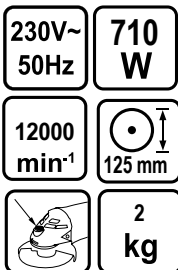

RAIDER[®]
Pro

Art.No	gross weight	in cartoon	barcode
020306	2.00 kg	2 pcs	3800972023086

ANGLE GRINDER RDP-AG43 BLACK EDITION

[BG] Ъглошлайф • [RO] Polizor unghiular • [SR] Brusilica ugaona • [MK] Брусилка • [RU] Угловая
шлифовальная машина • [SL] Kotni brusilnik • [EL] ΓΩΝΙΑΚΟΣ ΤΡΟΧΟΣ • [HR] Kutna brusilica
• [FR] Meuleuse à angle • [IT] Smerigliatrice angolare • [ES] Angulo muelillo • [PT] Rebarbadora

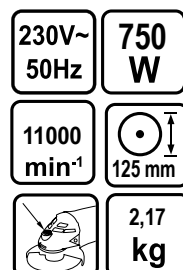

RAIDER[®]
Pro

Art.No	gross weight	in cartoon	barcode
020143	2.17 kg	1 pcs	3800123166839

ANGLE GRINDER RDP-AG62 BLACK EDITION

[BG] Ъглошлайф • [RO] Polizor unghiular • [SR] Brusilica ugaona • [MK] Брусилка • [RU] Угловая шлифовальная машина • [SL] Kotni brusilnik • [EL] ΓΩΝΙΑΚΟΣ ΤΡΟΧΟΣ • [HR] Kutna brusilica • [FR] Meuleuse à angle • [IT] Smerigliatrice angolare • [ES] Angulo muelillo • [PT] Rebarbadora



230V~ 50Hz	900 W
11000 min ⁻¹	125 mm
	2,5 kg



Art.No	gross weight	in cartoon	barcode
020302	2.5 kg	2 pcs	3800972015128

ANGLE GRINDER RDP-AG43 BLACK EDITION

[BG] Ъглошлайф • [RO] Polizor unghiular • [SR] Brusilica ugaona • [MK] Брусилка • [RU] Угловая шлифовальная машина • [SL] Kotni brusilnik • [EL] ΓΩΝΙΑΚΟΣ ΤΡΟΧΟΣ • [HR] Kutna brusilica • [FR] Meuleuse à angle • [IT] Smerigliatrice angolare • [ES] Angulo muelillo • [PT] Rebarbadora



230V~ 50Hz	910 W
6000- 12000 min ⁻¹	125 mm
	2,33 kg



Art.No	gross weight	in cartoon	barcode
020144	2.33 kg	1 pcs	3800123166822

ANGLE GRINDER RDP-AG67

[BG] Ъглошлайф • [RO] Polizor unghiular • [SR] Brusilica ugaona • [MK] Брусилка • [RU] Угловая шлифовальная машина • [SL] Kotni brusilnik • [EL] ΓΩΝΙΑΚΟΣ ΤΡΟΧΟΣ • [HR] Kutna brusilica • [FR] Meuleuse à angle • [IT] Smerigliatrice angolare • [ES] Angulo muelillo • [PT] Rebarbadora

230V~ 50Hz	1100 W
11000 min ⁻¹	125 mm
	2,10 kg



Art.No	gross weight	in cartoon	barcode
020305	2.10 kg	1 pcs	3800972020245

ANGLE GRINDER RDP-AG63 BLACK EDITION

[BG] Ъглошлайф • [RO] Polizor unghiular • [SR] Brusilica ugaona • [MK] Брусилка • [RU] Угловая шлифовальная машина • [SL] Kotni brusilnik • [EL] ΓΩΝΙΑΚΟΣ ΤΡΟΧΟΣ • [HR] Kutna brusilica • [FR] Meuleuse à angle • [IT] Smerigliatrice angolare • [ES] Angulo muelillo • [PT] Rebarbadora



230V~ 50Hz	1200 W
9000 min ⁻¹	125 mm
	3.0 kg



Art.No	gross weight	in cartoon	barcode
020303	3.0 kg	1 pcs	3800972015135

ANGLE GRINDER RDP-AG63 BLACK EDITION

[BG] Ъглошлайф • [RO] Polizor unghiular • [SR] Brusilica ugaona • [MK] Брусилка • [RU] Угловая шлифовальная машина • [SL] Kotni brusilnik • [EL] ΓΩΝΙΑΚΟΣ ΤΡΟΧΟΣ • [HR] Kutna brusilica • [FR] Meuleuse à angle • [IT] Smerigliatrice angolare • [ES] Angulo muelillo • [PT] Rebarbadora



230V~ 50Hz	1500 W
4000- 8000 min ⁻¹	125 mm
	3.42 kg



Art.No	gross weight	in cartoon	barcode
020304	3.42 kg	1 pcs	3800972015142

ANGLE GRINDER RDP-AG21Z

[BG] Ъглошлайф • [RO] Polizor unghiular • [SR] Brusilica ugaona • [MK] Брусилка • [RU] Угловая шлифовальная машина • [SL] Kotni brusilnik • [EL] ΓΩΝΙΑΚΟΣ ΤΡΟΧΟΣ • [HR] Kutna brusilica • [FR] Meuleuse à angle • [IT] Smerigliatrice angolare • [ES] Angulo muelillo • [PT] Rebarbadora



	230V~ 50Hz	1200W	150 mm
	8800min ⁻¹	22.2 mm	
		3.41 kg	COLOR BOX



Art.No	gross weight	in cartoon	barcode
020118	3.790 kg	4 pcs	3800123122552

ANGLE GRINDER RDP-AG65 BLACK EDITION

[BG] Ъглошлайф • [RO] Polizor unghiular • [SR] Brusilica ugaona • [MK] Брусилка • [RU] Угловая шлифовальная машина • [SL] Kotni brusilnik • [EL] ΓΩΝΙΑΚΟΣ ΤΡΟΧΟΣ • [HR] Kutna brusilica • [FR] Meuleuse à angle • [IT] Smerigliatrice angolare • [ES] Angulo muelillo • [PT] Rebarbadora

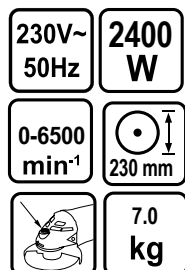

RAIDER[®]
Pro

Art.No	gross weight	in cartoon	barcode
020401	7.0 kg	1 pcs	3800972015159

ANGLE GRINDER RD-AG49

[BG] Ъглошлайф • [RO] Polizor unghiular • [SR] Brusilica ugaona • [MK] Брусилка • [RU] Угловая шлифовальная машина • [SL] Kotni brusilnik • [EL] ΓΩΝΙΑΚΟΣ ΤΡΟΧΟΣ • [HR] Kutna brusilica • [FR] Meuleuse à angle • [IT] Smerigliatrice angolare • [ES] Angulo muelillo • [PT] Rebarbadora

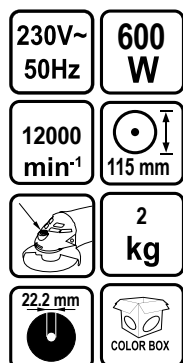

Art.No	gross weight	in cartoon	barcode
020147	2.170 kg	6 pcs	3800123166822

ANGLE GRINDER RD-AG66

[BG] Ъглошлайф • [RO] Polizor unghiular • [SR] Brusilica ugaona • [MK] Брусилка • [RU] Угловая шлифовальная машина • [SL] Kotni brusilnik • [EL] ΓΩΝΙΑΚΟΣ ΤΡΟΧΟΣ • [HR] Kutna brusilica • [FR] Meuleuse à angle • [IT] Smerigliatrice angolare • [ES] Angulo muelillo • [PT] Rebarbadora

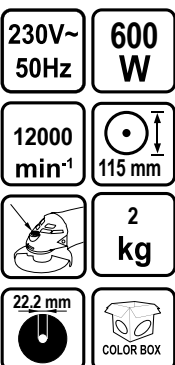

Art.No	gross weight	in cartoon	barcode
020154	2.170 kg	6 pcs	3800972018860

ANGLE GRINDER RD-AG34

[BG] Ъглошлайф • [RO] Polizor unghiular • [SR] Brusilica ugaona • [MK] Брусилка • [RU] Угловая шлифовальная машина • [SL] Kotni brusilnik • [EL] ΓΩΝΙΑΚΟΣ ΤΡΟΧΟΣ • [HR] Kutna brusilica • [FR] Meuleuse à angle • [IT] Smerigliatrice angolare • [ES] Angulo muelillo • [PT] Rebarbadora



Art.No	gross weight	in cartoon	barcode
020136	2.340 kg	6 pcs	3800123162466

ANGLE GRINDER RD-AG60

[BG] Ъглошлайф • [RO] Polizor unghiular • [SR] Brusilica ugaona • [MK] Брусилка • [RU] Угловая шлифовальная машина • [SL] Kotni brusilnik • [EL] ΓΩΝΙΑΚΟΣ ΤΡΟΧΟΣ • [HR] Kutna brusilica • [FR] Meuleuse à angle • [IT] Smerigliatrice angolare • [ES] Angulo muelillo • [PT] Rebarbadora

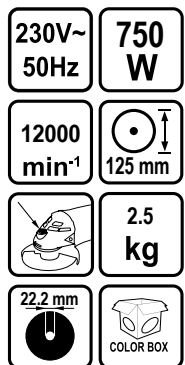

Art.No	gross weight	in cartoon	barcode
020153	2.700 kg	6 pcs	3800972009868

ANGLE GRINDER RD-AG51

[BG] Ъглошлайф • [RO] Polizor unghiular • [SR] Brusilica ugaona • [MK] Брусилка • [RU] Угловая шлифовальная машина • [SL] Kotni brusilnik • [EL] ΓΩΝΙΑΚΟΣ ΤΡΟΧΟΣ • [HR] Kutna brusilica • [FR] Meuleuse à angle • [IT] Smerigliatrice angolare • [ES] Angulo muelillo • [PT] Rebarbadora



Art.No	gross weight	in cartoon	barcode
020149	3.100 kg	4 pcs	3800972000780

ANGLE GRINDER RD-AG36

[BG] Ъглошлайф • [RO] Polizor unghiular • [SR] Brusilica ugaona • [MK] Брусилка • [RU] Угловая шлифовальная машина • [SL] Kotni brusilnik • [EL] ΓΩΝΙΑΚΟΣ ΤΡΟΧΟΣ • [HR] Kutna brusilica • [FR] Meuleuse à angle • [IT] Smerigliatrice angolare • [ES] Angulo muelillo • [PT] Rebarbadora

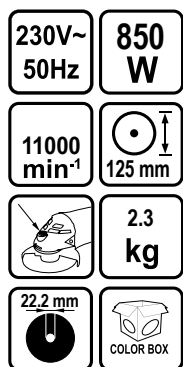

Art.No	gross weight	in cartoon	barcode
020138	2.600 kg	6 pcs	3800123162480

ANGLE GRINDER RD-AG44T

[BG] Ъглошлайф • [RO] Polizor unghiular • [SR] Brusilica ugaona • [MK] Брусилка • [RU] Угловая шлифовальная машина • [SL] Kotni brusilnik • [EL] ΓΩΝΙΑΚΟΣ ΤΡΟΧΟΣ • [HR] Kutna brusilica • [FR] Meuleuse à angle • [IT] Smerigliatrice angolare • [ES] Angulo muelillo • [PT] Rebarbadora



Art.No	gross weight	in cartoon	barcode
020145	2.600 kg	6 pcs	3800123167355

ANGLE GRINDER RD-AG37

[BG] Ъглошлайф • [RO] Polizor unghiular • [SR] Brusilica ugaona • [MK] Брусилка • [RU] Угловая шлифовальная машина • [SL] Kotni brusilnik • [EL] ΓΩΝΙΑΚΟΣ ΤΡΟΧΟΣ • [HR] Kutna brusilica • [FR] Meuleuse à angle • [IT] Smerigliatrice angolare • [ES] Angulo muelillo • [PT] Rebarbadora

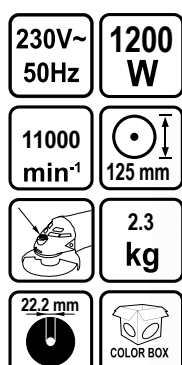

Art.No	gross weight	in cartoon	barcode
020139	2.500 kg	6 pcs	3800123162497

ANGLE GRINDER RD-AG39

[BG] Ъглошлайф • [RO] Polizor unghiular • [SR] Brusilica ugaona • [MK] Брусилка • [RU] Угловая шлифовальная машина • [SL] Kotni brusilnik • [EL] ΓΩΝΙΑΚΟΣ ΤΡΟΧΟΣ • [HR] Kutna brusilica • [FR] Meuleuse à angle • [IT] Smerigliatrice angolare • [ES] Angulo muelillo • [PT] Rebarbadora



Art.No	gross weight	in cartoon	barcode
020140	2.300 kg	6 pcs	3800123162534

ANGLE GRINDER RD-AG54

[BG] Ъглошлайф • [RO] Polizor unghiular • [SR] Brusilica ugaona • [MK] Брусилка • [RU] Угловая шлифовальная машина • [SL] Kotni brusilnik • [EL] ΓΩΝΙΑΚΟΣ ΤΡΟΧΟΣ • [HR] Kutna brusilica • [FR] Meuleuse à angle • [IT] Smerigliatrice angolare • [ES] Angulo muelillo • [PT] Rebarbadora



Art.No	gross weight	in cartoon	barcode
020152	4.0 kg	4 pcs	3800972000810

DUST EXTRACTION GUARD WITH VACUUM CLEANER HOSE ADAPTER FOR SANDING WITH ANGLE GRINDERS 125MM

Art.No	barcode
139504	3800972023710

ANGLE GRINDER RD-AG10T

[BG] Ъглошлайф • [RO] Polizor unghiular • [SR] Brusilica ugaona • [MK] Брусилка • [RU] Угловая шлифовальная машина • [SL] Kotni brusilnik • [EL] ΓΩΝΙΑΚΟΣ ΤΡΟΧΟΣ • [HR] Kutna brusilica • [FR] Meuleuse à angle • [IT] Smerigliatrice angolare • [ES] Angulo muelillo • [PT] Rebarbadora

230V~ 50Hz	1400 W
SOFT START	180 mm
	3.900 kg
4000- 8000 min ⁻¹	22.2 mm



Art.No	gross weight	in cartoon	barcode
020107	4.060 kg	2 pcs	3800123124617

ANGLE GRINDER RD-AG38

[BG] Ъглошлайф • [RO] Polizor unghiular • [SR] Brusilica ugaona • [MK] Брусилка • [RU] Угловая шлифовальная машина • [SL] Kotni brusilnik • [EL] ΓΩΝΙΑΚΟΣ ΤΡΟΧΟΣ • [HR] Kutna brusilica • [FR] Meuleuse à angle • [IT] Smerigliatrice angolare • [ES] Angulo muelillo • [PT] Rebarbadora

230V~ 50Hz	2350 W
SOFT START	230 mm
	5.200 kg
6000 min ⁻¹	22.2 mm



Art.No	gross weight	in cartoon	barcode
020201	5.760 kg	2 pcs	3800123162503

ANGLE GRINDER RD-AG55

[BG] Ъглошлайф • [RO] Polizor unghiular • [SR] Brusilica ugaona • [MK] Брусилка • [RU] Угловая шлифовальная машина • [SL] Kotni brusilnik • [EL] ΓΩΝΙΑΚΟΣ ΤΡΟΧΟΣ • [HR] Kutna brusilica • [FR] Meuleuse à angle • [IT] Smerigliatrice angolare • [ES] Angulo muelillo • [PT] Rebarbadora

230V~ 50Hz	2350 W
SOFT START	230 mm
	5.1 kg
6500 min ⁻¹	22.2 mm



Art.No	gross weight	in cartoon	barcode
020203	5.700 kg	2 pcs	3800972000827

ANGLE GRINDER RD-AG45

[BG] Ъглошлайф • [RO] Polizor unghiular • [SR] Brusilica ugaona • [MK] Брусилка • [RU] Угловая шлифовальная машина • [SL] Kotni brusilnik • [EL] ΓΩΝΙΑΚΟΣ ΤΡΟΧΟΣ • [HR] Kutna brusilica • [FR] Meuleuse à angle • [IT] Smerigliatrice angolare • [ES] Angulo muelillo • [PT] Rebarbadora

230V~ 50Hz	2500 W
SOFT START	230 mm
	6.3 kg
11000 min ⁻¹	22.2 mm



Art.No	gross weight	in cartoon	barcode
020202	6.580 kg	2 pcs	3800123171796



WALL CHASER RDP-WCH02

[BG] Фреза за канали • [RO] Cutter de canale • [SR] Rezač kanala • [MK] Секач за канали
 • [RU] Штроборез • [SL] Reznik kanalov • [EL] Κόφτης καναλιών • [HR] Rezač kanala
 • [FR] Coupe-canal • [IT] Tagliacanal • [ES] cortador de canales • [PT] Cortador de canal

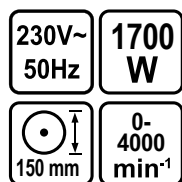

Art.No	gross weight	in cartoon	barcode
020901	5.700 kg	2 pcs	3800972022614

JIG SAW RD-JS31

[BG] Прободен трион • [RO] Ferstrau pendular • [SR] Ubodna testera • [MK] Убодна пила • [RU] Маятниковый лобзик • [SL] Nihajna vbodna žaga • [EL] Παλινδρομική σέγα • [HR] Ubodna pila • [FR] Électrique scie sauteuse • [IT] Sega • [ES] Elektra puzla • [PT] Tico-tico

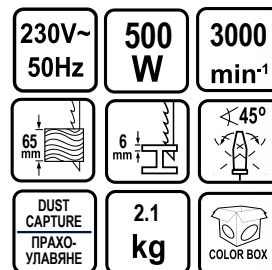

Art.No	gross weight	in cartoon	barcode
050126	2.200 kg	10 pcs	3800972009745

JIG SAW RD-JS32

[BG] Прободен трион • [RO] Ferstrau pendular • [SR] Ubodna testera • [MK] Убодна пила • [RU] Маятниковый лобзик • [SL] Nihajna vbodna žaga • [EL] Παλινδρομική σέγα • [HR] Ubodna pila • [FR] Électrique scie sauteuse • [IT] Sega • [ES] Elektra puzla • [PT] Tico-tico



Art.No	gross weight	in cartoon	barcode
050127	2.200 kg	10 pcs	3800972009864

JIG SAW RD-JS33

[BG] Прободен трион • [RO] Ferstrau pendular • [SR] Ubodna testera • [MK] Убодна пила • [RU] Маятниковый лобзик • [SL] Nihajna vbodna žaga • [EL] Παλινδρομική σέγα • [HR] Ubodna pila • [FR] Électrique scie sauteuse • [IT] Sega • [ES] Elektra puzla • [PT] Tico-tico



Art.No	gross weight	in cartoon	barcode
050128	2.150 kg	10 pcs	3800972009851

JIG SAW RD-JS28

[BG] Прободен трион • [RO] Ferstrau pendular • [SR] Ubodna testera • [MK] Убодна пила • [RU] Маятниковый лобзик • [SL] Nihajna vbodna žaga • [EL] Παλινδρομική σέγα • [HR] Ubodna pila • [FR] Électrique scie sauteuse • [IT] Sega • [ES] Elektra puzla • [PT] Tico-tico



Art.No	gross weight	in cartoon	barcode
050125	2.200 kg	10 pcs	3800972001190

JIG SAW RDP-JS25

[BG] Прободен трион • [RO] Ferstrau pendular • [SR] Ubodna testera • [MK] Убодна пила • [RU] Маятниковый лобзик • [SL] Nihajna vbodna žaga • [EL] Παλινδρομική σέγα • [HR] Ubodna pila • [FR] Électrique scie sauteuse • [IT] Sega • [ES] Elektra puzla • [PT] Tico-tico

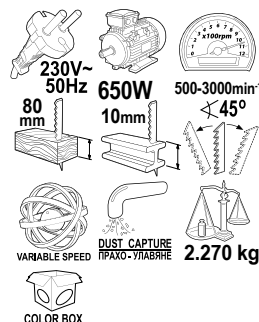

Art.No	gross weight	in cartoon	barcode
050119	2.520 kg	8 pcs	3800123167232

JIG SAW RDP-JS34

[BG] Прободен трион • [RO] Ferstrau pendular • [SR] Ubodna testera • [MK] Убодна пила • [RU] Маятниковый лобзик • [SL] Nihajna vbodna žaga • [EL] Πολινδρομική σέγα • [HR] Ubodna pila • [FR] Électrique scie sauteuse • [IT] Sega • [ES] Elektra puzla • [PT] Tico-tico

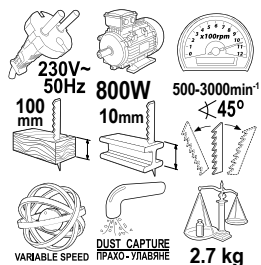

RAIDER[®]
Pro

Art.No	gross weight	in cartoon	barcode
050203	3.00 kg	5 pcs	3800972016361

JIG SAW RDP-JS21

[BG] Прободен трион • [RO] Ferstrau pendular • [SR] Ubodna testera • [MK] Убодна пила • [RU] Маятниковый лобзик • [SL] Nihajna vbodna žaga • [EL] Πολινδρομική σέγα • [HR] Ubodna pila • [FR] Électrique scie sauteuse • [IT] Sega • [ES] Elektra puzla • [PT] Tico-tico

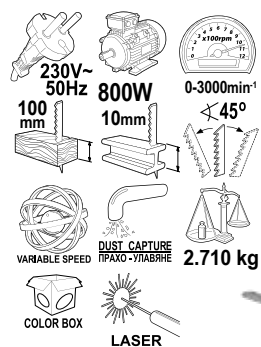

RAIDER[®]
Pro

Art.No	gross weight	in cartoon	barcode
050201	3.020 kg	10 pcs	3800123159022

JIG SAW RDP-JS26

[BG] Прободен трион • [RO] Ferstrau pendular • [SR] Ubodna testera • [MK] Убодна пила • [RU] Маятниковый лобзик • [SL] Nihajna vbodna žaga • [EL] Πολινδρομική σέγα • [HR] Ubodna pila • [FR] Électrique scie sauteuse • [IT] Sega • [ES] Elektra puzla • [PT] Tico-tico

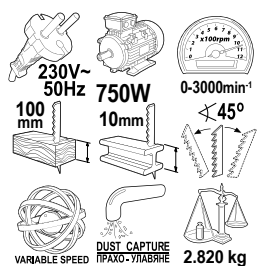

RAIDER[®]
Pro

Art.No	gross weight	in cartoon	barcode
050120	3.140 kg	5 pcs	3800123167249

RECIPROCATING SAW RD-RS29

[BG] Трион саблевиден • [RO] Fierastrau pendular • [SR] Sabljasta testera • [MK] Пила сабјарка • [RU] Сабельная пила • [SL] Nihajna vbodna žaga • [EL] Πριони σέγα • [HR] Recipro pila • [FR] Scie à mouvement alternative • [IT] Sega universal • [ES] Sierra de sable • [PT] Serra sabre

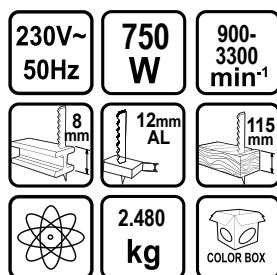

Art.No	gross weight	in cartoon	barcode
050129	2.880 kg	4 pcs	3800972010437

RECIPROCATING SAW RD-RS32

[BG] Трион саблевиден • [RO] Fierastrau pendular • [SR] Sabljasta testera • [MK] Сабельная пила • [RU] Сабельная пила • [SL] Nihajna vbodna žaga • [EL] Πριони σέγα • [HR] Recipro pila • [FR] Scie à mouvement alternative • [IT] Sega universal • [ES] Sierra de sable • [PT] Serra sabre

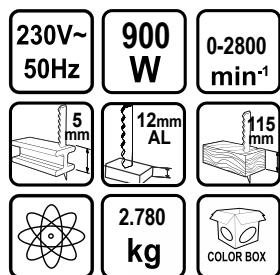

Art.No	gross weight	in cartoon	barcode
050131	3.000 kg	4 pcs	3800972016354

RECIPROCATING SAW RDP-RS28

[BG] Трион саблевиден • [RO] Fierastrau pendular • [SR] Sabljasta testera • [MK] Пила сабјарка • [RU] Сабельная пила • [SL] Nihajna vbodna žaga • [EL] Πριони σέγα • [HR] Recipro pila • [FR] Scie à mouvement alternative • [IT] Sega universal • [ES] Sierra de sable • [PT] Serra sabre

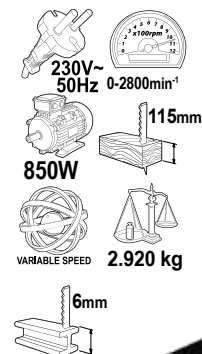

ROTATING HANDLE



RAIDER[®]
Pro

Art.No	gross weight	in cartoon	barcode
050202	3.260 kg	4 pcs	3800123173202

RECIPROCATING SAW RD-RS36

[BG] Трион саблевиден • [RO] Fierastrau pendular • [SR] Sabljasta testera • [MK] Пила сабјарка • [RU] Сабельная пила • [SL] Nihajna vbozna žaga • [EL] Πριονι σιγα • [HR] Recipro pila • [FR] Scie à mouvement alternative • [IT] Sega universal • [ES] Sierra de sable • [PT] Serra sabre



Art.No	gross weight	in cartoon	barcode
050136	3.260 kg	4 pcs	3800972026841

RECIPROCATING SAW RD-RS35

[BG] Трион саблевиден • [RO] Fierastrau pendular • [SR] Sabljasta testera • [MK] Пила сабјарка • [RU] Сабельная пила • [SL] Nihajna vbozna žaga • [EL] Πριονι σιγα • [HR] Recipro pila • [FR] Scie à mouvement alternative • [IT] Sega universal • [ES] Sierra de sable • [PT] Serra sabre



Art.No	gross weight	in cartoon	barcode
050135	3.260 kg	4 pcs	3800972026544

JIGSAW BLADE FOR WOOD "T" SHANK 2 PCS SET

[BG] Нож За Прободен Трион За Дърво "Т" 2 Бр. Комплект • [RO] Rezerve Ferestaru Pendular - 2Buc/Set • [SR] List Testere Za Ubodna Testera Set 2 Kom • [MK] Нож За Убодна Пила Сет 2 Ком • [RU] Полотно для лобзика Набор 2шт [SL] Žagin List 2 kos • [EL] Πριονόλαμες Σέγας Σет 2 τεμ • [HR] Listovi pile za drvo • [FR] Lame de scie pour scie sabre, lot de 2 • [IT]Seghetto per seghe a sciabola Set di 2 pezzi • [ES] Vidita Klingo Por Scianta Saúco Aro de 2pcs • [PT] Lâmina de serra para sabre Serras Conjunto de 2pcs

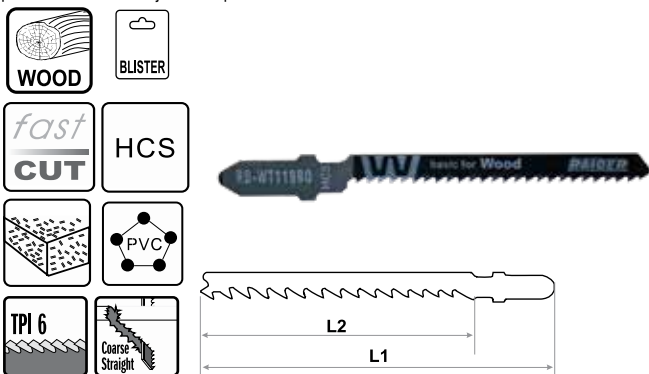

art. №	step mm	L1/mm	L2/mm	pcs	BARCODE
155401 RD-WT119BC	2	76	50	2	3800123164101

JIGSAW BLADE FOR WOOD "T" SHANK 2 PCS SET

[BG] Нож За Прободен Трион За Дърво "Т" 2 Бр. Комплект • [RO] Rezerve Ferestaru Pendular - 2Buc/Set • [SR] List Testere Za Ubodna Testera Set 2 Kom • [MK] Нож За Убодна Пила Сет 2 Ком • [RU] Полотно для лобзика Набор 2шт [SL] Žagin List 2 kos • [EL] Πριονόλαμες Σέγας Σет 2 τεμ • [HR] Listovi pile za drvo • [FR] Lame de scie pour scie sabre, lot de 2 • [IT]Seghetto per seghe a sciabola Set di 2 pezzi • [ES] Vidita Klingo Por Scianta Saúco Aro de 2pcs • [PT] Lâmina de serra para sabre Serras Conjunto de 2pcs

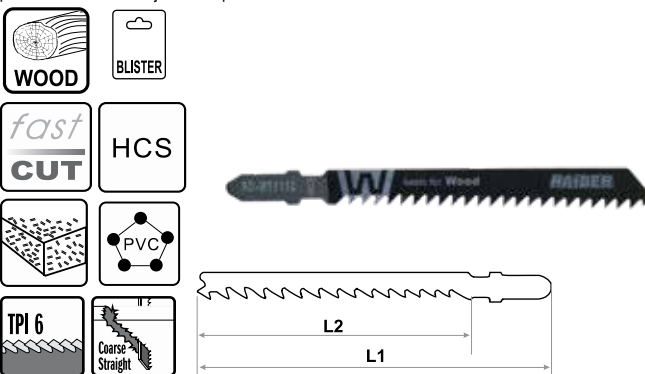

art. №	step mm	L1/mm	L2/mm	pcs	BARCODE
155402 RD-WT111C	3	100	75	2	3800123164118

JIGSAW BLADE FOR WOOD "T" SHANK 2 PCS SET

[BG] Нож За Прободен Трион За Дърво "Т" 2 Бр. Комплект • [RO] Rezerve Ferestaru Pendular - 2Buc/Set • [SR] List Testere Za Ubodna Testera Set 2 Kom • [MK] Нож За Убодна Пила Сет 2 Ком • [RU] Полотно для лобзика Набор 2шт [SL] Žagin List 2 kos • [EL] Πριονόλαμες Σέγας Σет 2 τεμ • [HR] Listovi pile za drvo • [FR] Lame de scie pour scie sabre, lot de 2 • [IT]Seghetto per seghe a sciabola Set di 2 pezzi • [ES] Vidita Klingo Por Scianta Saúco Aro de 2pcs • [PT] Lâmina de serra para sabre Serras Conjunto de 2pcs

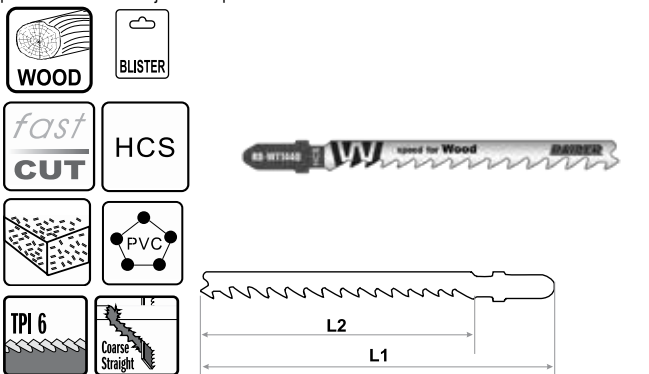

art. №	step mm	L1/mm	L2/mm	pcs	BARCODE
155403 RD-WT144D	4	100	75	2	3800123164125

JIGSAW BLADE FOR WOOD "T" SHANK 2 PCS SET

[BG] Нож За Прободен Трион За Дърво "Т" 2 Бр. Комплект • [RO] Rezerve Ferestaru Pendular - 2Buc/Set • [SR] List Testere Za Ubodna Testera Set 2 Kom • [MK] Нож За Убодна Пила Сет 2 Ком • [RU] Полотно для лобзика Набор 2шт [SL] Žagin List 2 kos • [EL] Πριονόλαμες Σέγας Σет 2 τεμ • [HR] Listovi pile za drvo • [FR] Lame de scie pour scie sabre, lot de 2 • [IT]Seghetto per seghe a sciabola Set di 2 pezzi • [ES] Vidita Klingo Por Scianta Saúco Aro de 2pcs • [PT] Lâmina de serra para sabre Serras Conjunto de 2pcs

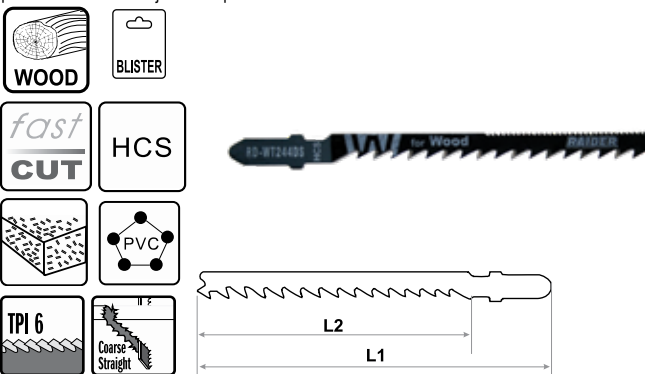

art. №	step mm	L1/mm	L2/mm	pcs	BARCODE
155404 RD-WT244DS	4	100	75	2	3800123164132

JIGSAW BLADE FOR WOOD "T" SHANK 2 PCS SET

[BG] Нож За Прободен Трион За Дърво "Т" 2 Бр. Комплект • [RO] Rezerve Ferestaru Pendular - 2Buc/Set • [SR] List Testere Za Ubodna Testera Set 2 Kom • [MK] Нож За Убодна Пила Сет 2 Ком • [RU] Полотно для лобзика Набор 2шт [SL] Žagin List 2 kos • [EL] Приονόλαμες Σέγας Σет 2 τεμ • [HR] Listovi pile za drvo • [FR] Lame de scie pour scie sabre, lot de 2 • [IT] Seghetto per seghe a sciabola Set di 2 pezzi • [ES] Vidita Klingo Por Scienta Saúco Aro de 2pcs • [PT] Lâmina de serra para sabre Serras Conjunto de 2pcs

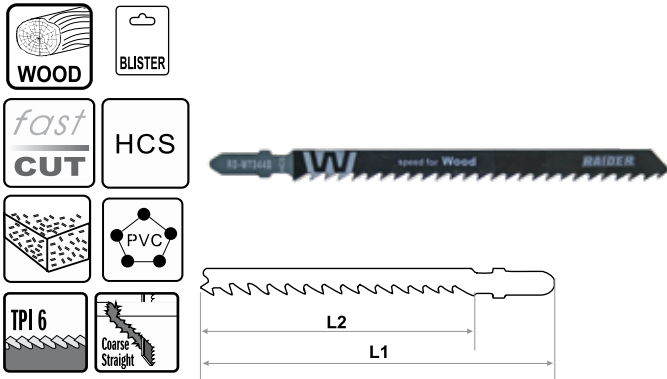

art. №	step mm	L1/mm	L2/mm	pcs	BARCODE
155405 RD-WT344D	4	132	110	2	3800123164149

JIGSAW BLADE FOR WOOD "T" SHANK 2 PCS SET

[BG] Нож За Прободен Трион За Дърво "Т" 2 Бр. Комплект • [RO] Rezerve Ferestaru Pendular - 2Buc/Set • [SR] List Testere Za Ubodna Testera Set 2 Kom • [MK] Нож За Убодна Пила Сет 2 Ком • [RU] Полотно для лобзика Набор 2шт [SL] Žagin List 2 kos • [EL] Приονόλαμες Σέγας Σет 2 τεμ • [HR] Listovi pile za drvo • [FR] Lame de scie pour scie sabre, lot de 2 • [IT] Seghetto per seghe a sciabola Set di 2 pezzi • [ES] Vidita Klingo Por Scienta Saúco Aro de 2pcs • [PT] Lâmina de serra para sabre Serras Conjunto de 2pcs

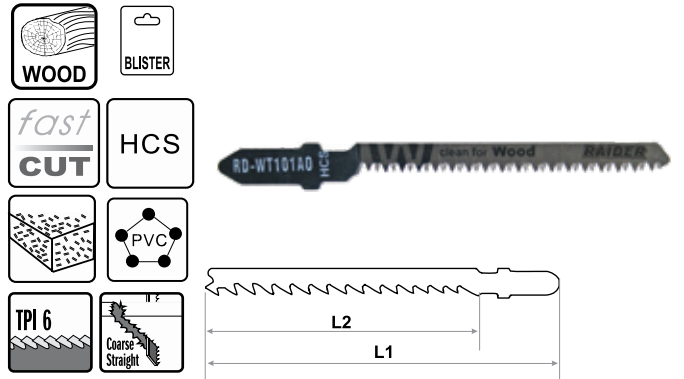

art. №	step mm	L1/mm	L2/mm	pcs	BARCODE
155406 RD-WT101AO	1.4	76	50	2	3800123164156

JIGSAW BLADE FOR WOOD "T" SHANK 2 PCS SET

[BG] Нож За Прободен Трион За Дърво "Т" 2 Бр. Комплект • [RO] Rezerve Ferestaru Pendular - 2Buc/Set • [SR] List Testere Za Ubodna Testera Set 2 Kom • [MK] Нож За Убодна Пила Сет 2 Ком • [RU] Полотно для лобзика Пил Набор 2шт [SL] Žagin List 2 kos • [EL] Приονόλαμες Σέγας Σет 2 τεμ • [HR] Listovi pile za drvo • [FR] Lame de scie pour scie sabre, lot de 2 • [IT] Seghetto per seghe a sciabola Set di 2 pezzi • [ES] Vidita Klingo Por Scienta Saúco Aro de 2pcs • [PT] Lâmina de serra para sabre Serras Conjunto de 2pcs

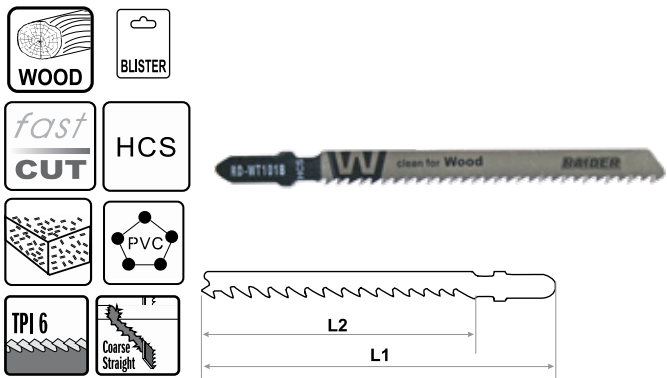

art. №	step mm	L1/mm	L2/mm	pcs	BARCODE
155407 RD-WT101B	2.5	100	75	2	3800123164163

JIGSAW BLADE FOR WOOD "T" SHANK 2 PCS SET

[BG] Нож За Прободен Трион За Дърво "Т" 2 Бр. Комплект • [RO] Rezerve Ferestaru Pendular - 2Buc/Set • [SR] List Testere Za Ubodna Testera Set 2 Kom • [MK] Нож За Убодна Пила Сет 2 Ком • [RU] Полотно для лобзика Набор 2шт [SL] Žagin List 2 kos • [EL] Приονόλαμες Σέγας Σет 2 τεμ • [HR] Listovi pile za drvo • [FR] Lame de scie pour scie sabre, lot de 2 • [IT] Seghetto per seghe a sciabola Set di 2 pezzi • [ES] Vidita Klingo Por Scienta Saúco Aro de 2pcs • [PT] Lâmina de serra para sabre Serras Conjunto de 2pcs

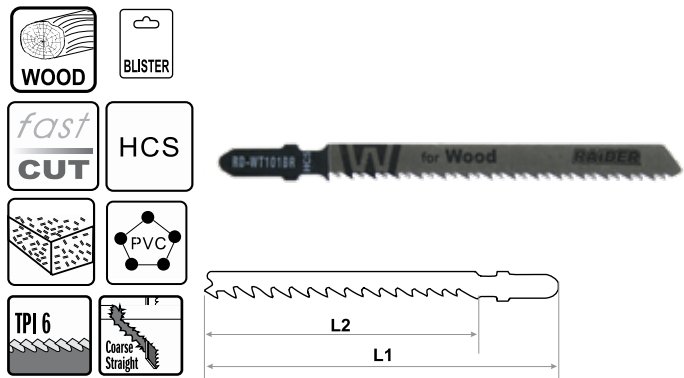

art. №	step mm	L1/mm	L2/mm	pcs	BARCODE
155408 RD-WT101BR	2.5	100	75	2	3800123164170

JIGSAW BLADE FOR WOOD "T" SHANK 2 PCS SET

[BG] Нож За Прободен Трион За Дърво "Т" 2 Бр. Комплект • [RO] Rezerve Ferestaru Pendular - 2Buc/Set • [SR] List Testere Za Ubodna Testera Set 2 Kom • [MK] Нож За Убодна Пила Сет 2 Ком • [RU] Полотно для лобзика Набор 2шт [SL] Žagin List 2 kos • [EL] Приονόλαμες Σέγας Σет 2 τεμ • [HR] Listovi pile za drvo • [FR] Lame de scie pour scie sabre, lot de 2 • [IT] Seghetto per seghe a sciabola Set di 2 pezzi • [ES] Vidita Klingo Por Scienta Saúco Aro de 2pcs • [PT] Lâmina de serra para sabre Serras Conjunto de 2pcs

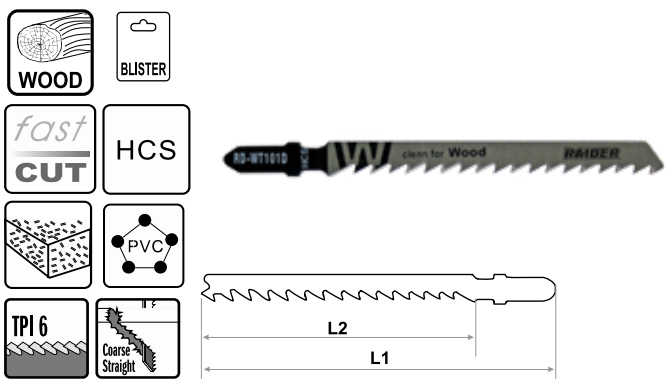

art. №	step mm	L1/mm	L2/mm	pcs	BARCODE
155409 RD-WT101D	4	100	75	2	3800123164187

JIGSAW BLADE FOR WOOD "T" SHANK 2 PCS SET

[BG] Нож За Прободен Трион За Дърво "Т" 2 Бр. Комплект • [RO] Rezerve Ferestaru Pendular - 2Buc/Set • [SR] List Testere Za Ubodna Testera Set 2 Kom • [MK] Нож За Убодна Пила Сет 2 Ком • [RU] Полотно для лобзика Набор 2шт [SL] Žagin List 2 kos • [EL] Приονόλαμες Σέγας Σет 2 τεμ • [HR] Listovi pile za drvo • [FR] Lame de scie pour scie sabre, lot de 2 • [IT] Seghetto per seghe a sciabola Set di 2 pezzi • [ES] Vidita Klingo Por Scienta Saúco Aro de 2pcs • [PT] Lâmina de serra para sabre Serras Conjunto de 2pcs

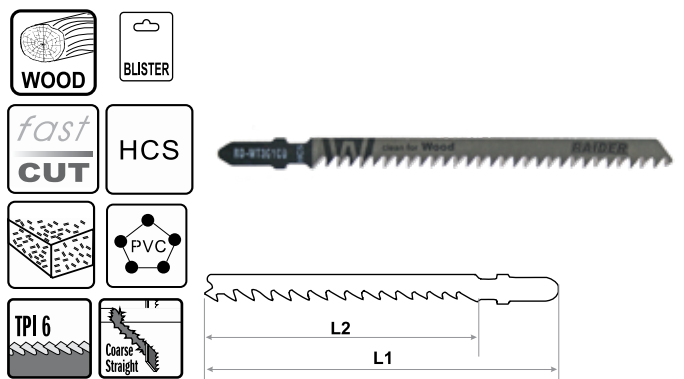

art. №	step mm	L1/mm	L2/mm	pcs	BARCODE
155410 RD-WT301CD	3	116	90	2	3800123164194

JIGSAW BLADE FOR WOOD "T" SHANK 2 PCS SET

[BG] Нож За Прободен Трион За Дърво "Т" 2 Бр. Комплект • [RO] Rezerve Ferestaru Pendular - 2Buc/Set • [SR] List Testere Za Ubodna Testera Set 2 Kom • [MK] Нож За Убодна Пила Сет 2 Ком • [RU] Полотно для лобзика Набор 2шт [SL] Žagin List 2 kos • [EL] Приονόλαμες Σέγας Σετ 2 τεμ • [HR] Listovi pile za drvo • [FR] Lame de scie pour scie sabre, lot de 2 • [IT] Seghetto per seghe a sciabola Set di 2 pezzi • [ES] Vidita Klingo Por Scianta Saúco Aro de 2pcs • [PT] Lâmina de serra para sabre Serras Conjunto de 2pcs

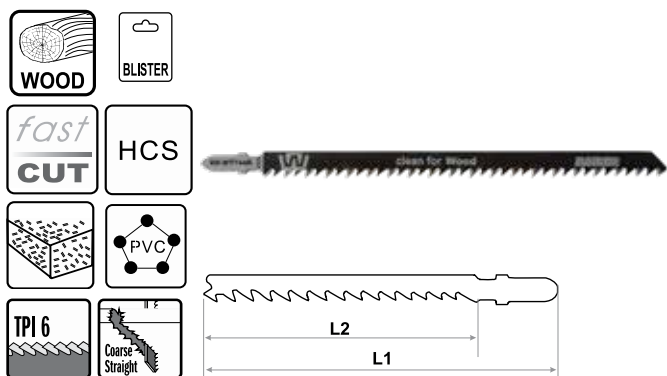

art. №	step mm	L1/mm	L2/mm	pcs	BARCODE
155419** RD-WT744D	4	180	155	2	3800972009707

JIGSAW BLADES FOR WOOD "T" 116(90) 2PCS. RD-WT344CB

[BG] Нож За Прободен Трион За Дърво "Т" 2 Бр. Комплект • [RO] Rezerve Ferestaru Pendular - 2Buc/Set • [SR] List Testere Za Ubodna Testera Set 2 Kom • [MK] Нож За Убодна Пила Сет 2 Ком • [RU] Полотно для лобзика Набор 2шт [SL] Žagin List 2 kos • [EL] Приονόλαμες Σέγας Σετ 2 τεμ • [HR] Listovi pile za drvo • [FR] Lame de scie pour scie sabre, lot de 2 • [IT] Seghetto per seghe a sciabola Set di 2 pezzi • [ES] Vidita Klingo Por Scianta Saúco Aro de 2pcs • [PT] Lâmina de serra para sabre Serras Conjunto de 2pcs

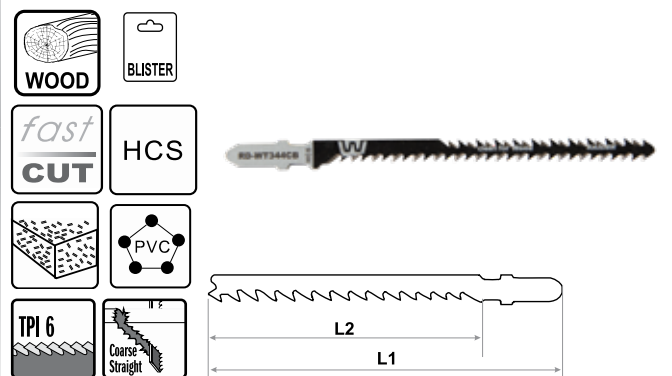

art. №	step mm	L1/mm	L2/mm	pcs	BARCODE
155418 RD-WT344CB	4	180	155	2	3800972009691

JIGSAW BLADE CARBIDE "T" SHANK

[BG] Нож За Прободен Трион Carbide "Т" • [RO] Rezerve Ferestaru Pendular - Carbide "Т" • [SR] List Testere Za Ubodna Testera Carbide "Т" • [MK] Нож За Убодна Пила Carbide "Т" • [RU] Полотно для лобзика Carbide "Т" • [SL] Žagin List Carbide "Т" • [EL] Приονόλαμες σέγας Carbide "Т" • [HR] Listovi pile za metal Carbide "Т" • [FR] Ensemble Carbide "Т" [IT] Seghetto Carbide "Т" • [ES] Vidita Carbide "Т" • [PT] Lâmina Carbide "Т"

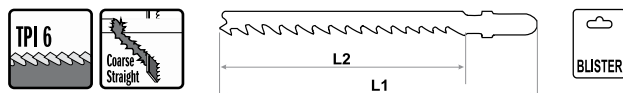

art. №	mm	L1/mm	L2/mm	pcs	BARCODE
155417 RD-CT141HM	4.3	100	75	2	3800972009684

JIGSAW BLADE FOR METAL "T" SHANK

[BG] Нож За Прободен Трион За Метал "Т" 2 Бр. Комплект • [RO] Rezerve Ferestaru Pendular - 2Buc/Set • [SR] List Testere Za Ubodna Testera Set 2 Kom • [MK] Нож За Убодна Пила Сет 2 Ком • [RU] Полотно для лобзика Набор 2шт • [SL] Žagin List 2 kos • [EL] Приονόλαμες σέγας Σετ 2 τεμ • [HR] Listovi pile za metal • [FR] Ensemble de 2 lames de scie sauteuse pour tige en "Т" en métal • [IT] Seghetto per seghe a sciabola Set di 2 pezzi • [ES] Vidita Klingo Por Scianta Saúco Aro de 2pcs • [PT] Lâmina de serra para sabre Serras Conjunto de 2pcs

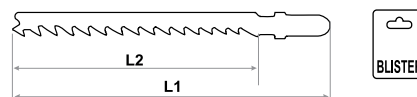

art. №	mm	L1/mm	L2/mm	pcs	BARCODE
155411 RD-MT118G	0.8	76	50	2	3800123164200
154412 RD-MT118A	1.2	76	50	2	3800123164217

ASSORTED JIGSAW BLADES "T" SHANK SET

[BG] Нож за Прободен Трион за дърво & метал "Т" • [RO] Rezerve ferestaru pendular set • [SR] List testere za ubodna testera set • [MK] Нож за убодна пила сет • [RU] Полотно для лобзика набор • [SL] žagin list • [EL] Приονόλαμες σέγας Σετ • [HR] Listovi pile • [FR] Lame de scie pour scie sabre sets • [IT] Lama per sega a sciabola set • [ES] Širita klingo por sabročambroj starigis 5 komputilojn • [PT] Lâmina de serra para serras de sabre com



art. №	models	pcs	BARCODE
155413	T119BO, T144D, T101B, T111C, T118A	5	3800123164224

ASSORTED JIGSAW BLADES "T" SHANK SET

[BG] Нож за Прободен Трион за дърво & метал "Т" • [RO] Rezerve ferestaru pendular set • [SR] List testere za ubodna testera set • [MK] Нож за убодна пила сет • [RU] Полотно для лобзика набор • [SL] žagin list • [EL] Приονόλαμες σέγας Σετ • [HR] Listovi pile • [FR] Lame de scie pour scie sabre sets • [IT] Lama per sega a sciabola set • [ES] Širita klingo por sabročambroj starigis 5 komputilojn • [PT] Lâmina de serra para serras de sabre com



art. №	models	pcs	BARCODE
155414	T19BO 2pcs; T144D 2pcs; T101B 2pcs.; T111C 2pcs.; T118A 1pcs.; T118G 1pcs.	10	3800123164231

ASSORTED JIGSAW BLADES "T" SHANK SET

[BG] Нож за Прободен Трион за дърво & метал "Т" • [RO] Rezerve ferestaru pendular set • [SR] List testere za uobodna testera set • [MK] Нож за уводна пила сет • [RU] Полотно для лобзика набор • [SL] žagin list • [EL] Приονόλαμες σέγας Σετ • [HR] Listovi pile • [FR] Lame de scie pour scie sabre sets • [IT] Lama per sega a sciabola set • [ES] Širitita klingo por sabročambro starigis 5 komputilojn • [PT] Lâmina de serra para serras de sabre com

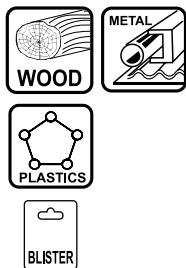

art. №	models	pcs	BARCODE
155416	T119BO 2pcs.; T144D 2pcs.; T101B 2pcs.; T123X 1pcs.; T111C 2pcs.; T118A 2pcs.; T118B 3pcs.; T101BR 2pcs.	16	3800972009677

JIGSAW BLADES "T" SHANK 5 PCS. SET

[BG] Нож за прободен трион "Т" 5 бр. комплект • [RO] Rezerve ferestaru pendular-5buc/set • [SR] List testere za uobodna testera set 5 kom • [MK] Нож за уводна пила сет 5 ком • [RU] Полотно для лобзика набор 5 шт [SL] žagin list 5 kos • [EL] Приονόλαμες σέγας Σετ 5 τεμ • [HR] Listovi pile za drvo 5 kom • [FR] Couteau à découper "T" 5 pcs. kit • [IT] Coltello da taglio "T" 5 pz. set • [ES] Tranchilo trančilo "T" 5 PC. kit • [PT] Faca de corte "T" 5 pçs. kit



art. №	tpi	pcs	BARCODE
209911 for wood	8	5	3800123107269



RECIPROCATING SAW BLADE FOR WOOD 10TPI HSS

[BG] Нож за саблевиден трион за дърво • [RO] Lama ferestrau sabie ptr lemn HSS • [SR] List testere za sabljasta testera za drvo • [MK] Нож за уводна пила за дърво • [RU] Полотно для сабельной пилы • [SL] Žagin list za nihajna vobodna žaga • [EL] Приονόλαμες σέγας πριони σεγα • [HR] Listovi pile za drvo za Recipročna pila • [FR] Soucoupe scie à bois • [IT] Seghe piatte per legno • [ES] Saucer vidis por ligno • [PT] Serra de discos para madeira

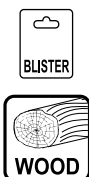

art. №	length/mm	tpi	pcs	BARCODE
155502 RD-WS1531L	240x19x1.5	10	2	3800123164248
155420 RD-WS644D	150x1.25x4.3		2	3800972009714
155421 RD-WS1111K	225x1.25x8.5		2	3800972009721

RECIPROCATING SAW BLADE FOR WOOD AND METAL 2 PCS.

[BG] Нож за саблевиден трион за дърво и метал • [RO] Lama ferestrau sabie ptr lemn HSS • [SR] List testere za sabljasta testera za drvo • [MK] Нож за уводна пила за дърво • [RU] Полотно для сабельной пилы • [SL] Žagin list za nihajna vobodna žaga • [EL] Приονόλαμες σέγας πριони сега • [HR] Listovi pile za drvo za Recipročna pila • [FR] Soucoupe scie à bois • [IT] Seghe piatte per legno • [ES] Saucer vidis por ligno • [PT] Serra de discos para madeira



art. №	length/mm	tpi	pcs	BARCODE
155422	225x0.9(1.8-2.6)	10	2	3800972009738

RECIPROCATING SAW BLADE FOR METAL

[BG] Нож за саблевиден трион за метал • [RO] Lama ferestrau sabie ptr metal HSS • [SR] List testere za sabljasta testera za metal • [MK] Нож за уводна пила за метал • [RU] Полотно для сабельной пилы • [SL] Žagin list za nihajna vobodna žaga • [EL] Приονόλαμες σέγας πριони сега • [HR] Listovi pile za metal za Recipročna pila • [FR] Lame de scie alternative pour métal • [IT] Seghetto alternativo per metallo • [ES] Reciprocating Saw Blade for Metalo • [PT] Lâmina de Serra Reciprocante para Metal

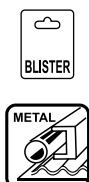

art. №	length/mm	tpi	pcs	BARCODE
155503	225x19x0.9	24	2	3800123164255

RECIPROCATING SAW BLADE FOR BRICKS RD-RS2243

[BG] Нож за саблевиден трион за тухли • [RO] Lama ferestrau sabie ptr cărămidă • [SR] List testere za sabljasta testera za oreke • [MK] Нож за уводна пила за тухла • [RU] Полотно для сабельной пилы • [SL] Žagin list za nihajna vobodna žaga • [EL] Приονόλαμες σέγας πριони сега • [HR] Listovi pile za cigla za Recipročna pila • [FR] Lame de scie alternative pour briques • [IT] Seghetto alternativo per mattoni • [ES] Reciproca Sudo-klingo por Brikoj • [PT] Lâmina de Serra Reciprocante para Tijolos

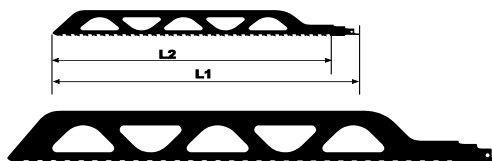

art. №	mm	L1/mm	L2/mm	pcs	BARCODE
155415	12..7	455	405	1	3800123173813

MULTI-TOOL RD-OMT01

[BG] Многофункционален инструмент • [RO] Unealta multifunctionala • [SR] Višenamenski alat • [MK] Повеќенаменски алат • [RU] Многофункциональный инструмент • [SL] Večnamensko orodje • [EL] Πολυεργαλείο μπαταρίας • [HR] Višenamjenski alat • [FR] Outil multifonctionnel • [IT] Multi-utensile oscillante • [ES] Herramienta multifuncional • [PT] Multi-ferramenta oscilante



Art.No	gross weight	in cartoon	barcode
050115	2.070 kg	5 pcs	3800123163623

SAW BLADE FOR OSCILLATING MULTI-TOOL FOR WOOD

[BG] Нож за многофункционален инструмент за дърво • [RO] Rezerve ptr sculă multifuncțională • [SR] List testere za višenamenski alat • [MK] Нож за повеќенаменски алат • [RU] Пильное полотно для многофункциональный инструмент • [SL] Žagin list za večnamensko orodje • [EL] Μαχαιρί για εργαλείο πολλαπλής χρήσης • [HR] Ravna oštrica • [FR] Lame de scie pour outil polyvalent oscillant pour bois • [IT] Lama per sega per utensile oscillante per legno • [ES] Sírta klingon por oscillating multi-tool por wood • [PT] Lámina de serra para multiferramenta oscilante para madeira

34x40mm

Art. No. 155601
EAN: 3800123164507



SAW BLADE FOR OSCILLATING MULTI-TOOL FOR METAL & WOOD

[BG] Нож за Многофункционален Инструмент за метал и дърво • [RO] Rezerve ptr Sculă Multifuncțională [SR] List Testere Za Višenamenski Alat [MK] Нож За Повеќенаменски Алат • [RU] Пильное Полотно Для Многофункциональный Инструмент • [SL] Žagin List za Večnamensko Orodje • [EL] μαχαιρί για Εργαλείο Πολλαπλής Χρήσης • [HR] Ravna oštrica • [FR] Lame de scie pour outil polyvalent oscillant pour métal et bois • [IT] Saw Blade for Oscillating Multi-Tool per metallo e legno • [ES] Saw Blade por Oscillating Multi-Tool por Metallo & Ligno • [PT] Lámina de serra para multiferramenta oscilante para metal e madeira

32x40mm

Art. No. 155602
EAN: 3800123164514

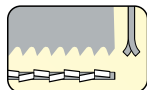

Milled and side set teeth



SAW BLADE FOR OSCILLATING MULTI-TOOL FOR WOOD

Ø 87mm

Art. No. 155603
EAN: 3800123164521

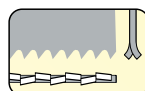

Milled and side set teeth



SAW BLADE FOR OSCILLATING MULTI-TOOL FOR METAL & WOOD

Ø 87mm

Art. No. 155604
EAN: 3800123164538



SCRAPER FOR OSCILLATING MULTI-TOOL

[BG] Шабър за многофункционален инструмент • [RO] Rezerve ptr sculă multifuncțională • [SR] Strugač za višenamenski alat • [MK] Стругало за повеќенаменски алат [RU] Скребок для многофункциональный инструмент [SL] Strgalo za večnamensko orodje • [EL] Ξύστρα για εργαλείο πολλαπλής χρήσης • [HR] Strugač [FR] Racloir pour outil polyvalent oscillant • [IT] Raschietto per multi attrezzo oscillante • [ES] Skrapilo por oscilla multi-ilo • [PT] Raspador para multiferramenta oscilante

52x45mm

Art. No. 155605
EAN: 3800123164545



SAW BLADE FOR OSCILLATING MULTI-TOOL CARBIDE

[BG] Нож за многофункционален инструмент за фуги Carbide • [RO] Rezervez ptr Sculă Multifuncțională Carbide • [SR] List Testere Za Višenamenski Alat Carbide • [MK] Нож За Повеќенаменски Алат • [RU] Пильное Полотно Для Многофункциональный Инструмент • [SL] Žagin List za Večnamensko Orodje Carbide • [EL] μαχαίρι για Εργαλείο Πολλαπλής Χρήσης Carbide • [HR] Okrugla oštrica • [FR] Lame de scie pour outil polyvalent oscillant • [IT] Lama per sega per attrezzo oscillante multi-utensile • [ES] Saw Blade por Oscilla Multi-Ilo • [PT] Lâmina de serra para multi-ferramenta oscilante

Ø **85mm**

Art. No. 155606

EAN: 3800123164552



CARBIDE



SANDING PLATE FOR MULTI-TOOL VELCRO

[BG] Шлифовъчна плоча за многофункционален инструмент Velcro • [RO] Placă de Şlefuire ptr Sculă Multifuncțională Velcro [SR] Brusna ploča Za Višenamenski Alat • [MK] Плоча за Брусьење За Повеќенаменски Алат • [RU] Шлифпластина Для Многофункциональный Инструмент • [SL] Brušenje Ploščo za Večnamensko Orodje Velcro • [EL] Πλάκα Λείανσης για Εργαλείο Πολλαπλής Χρήσης Velcro • [HR] Brusni disk • [FR] Plaque de ponçage pour velcro multi-outils • [IT] Piastra di levigatura per velcro oscillante multi-utensile • [ES] Sanding Plate por Multi-Ila Velcro • [PT] Placa de lixamento para o velcro oscilante de várias ferramentas

93mm

Art. No. 155608

EAN: 3800123164576



SANDING PLATE FOR OSCILLATING MULTI-TOOL CARBIDE

[BG] Шлифовъчна плоча за многофункционален инструмент Carbide • [RO] Placă de Şlefuire ptr Sculă Multifuncțională Carbide • [SR] Brusna ploča Za Višenamenski Alat • [MK] Плоча за Брусьење За Повеќенаменски Алат • [RU] Шлифпластина Для Многофункциональный Инструмент [SL] Brušenje Ploščo za Večnamensko Orodje Carbide • [EL] Πλάκα Λείανσης για Εργαλείο Πολλαπλής Χρήσης Carbide • [HR] Brusni disk • [FR] Plateau abrasif pour carbure multi-utensile oscillant • [IT] Piastra di levigatura per carburo multi-utensile oscillante • [ES] Sanding Plate por Oscilla Multi-Ilo • [PT] Placa de lixamento para multi-ferramenta oscilante

80mm

Art. No. 155607

EAN: 3800123164569



CARBIDE



SANDING SHEETS FOR OSCILLATING MULTI-TOOL 10 PCS

[BG] Шкурка за многофункционален инструмент 10 бр. комплект Velcro • [RO] 10Psc/Set banda smirghel ptr Sculă Multifuncțională Velcro • [SR] Brusni papir 10 kom za Višenamenski Alat • [MK] Абразивна Хартија 10 ком за Повеќенаменски Алат • [RU] Бумага наждачная 10 шт. Для Многофункциональный Инструмент • [SL] Brusni platna 10 kos za Večnamensko Orodje Velcro • [EL] Γυαλόχαρτο Σετ 10 Τεμ για Εργαλείο Πολλαπλής Χρήσης Velcro • [HR] Brusni papir 10 kom • [FR] Lame de scie pour outil polyvalent oscillant • [IT] Lama per sega per attrezzo oscillante multi-utensile • [ES] Saw Blade por Oscilla Multi-Ilo • [PT] Lâmina de serra para multi-ferramenta oscilante

GRIT: 60-240

93mm

Art. No. 155609

EAN: 3800123164583



ACCESSORIES FOR OSCILLATING MULTIFUNCTIONAL TOOL 10PCS. KIT

[BG] Аксесоари за многофункционален инструмент 10 бр. комплект • [RO] Set 10 buc banda smirghel Velcro pentru scula multifunctionala • [SR] Prinađležnosti 10 kom za višenamenski alat • [MK] Додатоци 10 ком за повеќенаменски алат • [RU] Аксессуары 10 шт. для многофункциональный инструмент • [SL] Dodatki 10 kos za večnamensko orodje • [EL] Αξεσουάρ Σετ 10 Τεμ για Εργαλείο Πολλαπλής Χρήσης • [HR] Oscilacijski alat 10 kom • [FR] Accessoires pour outil multifonction oscillant 10 pcs. Trousse • [IT] Accessori per utensile multifunzione oscillante 10 pz. Kit • [ES] Accesorajoj por Oscillating Multifunction Tool 10 komputiloj. Kit • [PT] Acessórios para ferramenta multifuncional oscilante 10 pcs.



Art. No. 155610

EAN: 3800123164613

155609 6pcs; 155608 1pc;

155605 1pc;

155604 1pc, Saw Blade 28 mm



10pcs



SANDER RD-SA26

[BG] Виброшлайф • [RO] Slefuitor cu vibratii • [SR] Brusilica vibraciona • [MK] Виброшлјаферица • [RU] Шлифмашина вибрационная • [SL] Vibracijski brusilnik • [EL] Τριβείο • [HR] Jednorusna brusilica • [FR] Ponceuse électrique • [IT] Sanderia elettrica • [ES] Elektra sandero • [PT] Lixadora



Art.No	gross weight	in cartoon	barcode
040115	2.0 kg	10 pcs	3800972010413

SANDER RD-SA08

[BG] Виброшлайф • [RO] Slefuitor cu vibratii • [SR] Brusilica vibraciona • [MK] Виброшлјаферица • [RU] Шлифмашина вибрационная • [SL] Vibracijski brusilnik • [EL] Τριβείο • [HR] Jednorusna brusilica • [FR] Ponceuse électrique • [IT] Sanderia elettrica • [ES] Elektra sandero • [PT] Lixadora



Art.No	gross weight	in cartoon	barcode
040112	2.310 kg	8 pcs	3800123160813

SANDER RDP-SA22

[BG] Виброшлайф • [RO] Slefuitor cu vibratii • [SR] Brusilica vibraciona • [MK] Виброшлјаферица • [RU] Шлифмашина вибрационная • [SL] Vibracijski brusilnik • [EL] Τριβείο • [HR] Jednorusna brusilica • [FR] Ponceuse électrique • [IT] Sanderia elettrica • [ES] Elektra sandero • [PT] Lixadora

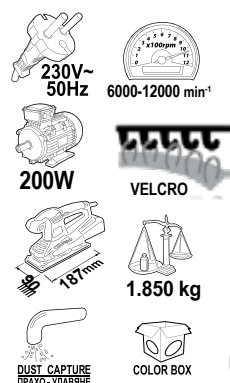
RAIDER®
Pro

Art.No	gross weight	in cartoon	barcode
040401	2.060 kg	5 pcs	3800123167263

SANDER RD-SA 19

[BG] Виброшлайф • [RO] Slefuitor cu vibratii • [SR] Brusilica vibraciona • [MK] Виброшлјаферица • [RU] Шлифмашина вибрационная • [SL] Vibracijski brusilnik • [EL] Τριβείο • [HR] Jednorusna brusilica • [FR] Ponceuse électrique • [IT] Sanderia elettrica • [ES] Elektra sandero • [PT] Lixadora



Art.No	gross weight	in cartoon	barcode
040111	1.710 kg	8 pcs	3800123151477

SANDER RDP-SA27 BLACK EDITION

[BG] Виброшлайф • [RO] Slefuitor cu vibratii • [SR] Brusilica vibraciona • [MK] Виброшлјаферица • [RU] Шлифмашина вибрационная • [SL] Vibracijski brusilnik • [EL] Τριβείο • [HR] Jednorusna brusilica • [FR] Ponceuse électrique • [IT] Sanderia elettrica • [ES] Elektra sandero • [PT] Lixadora

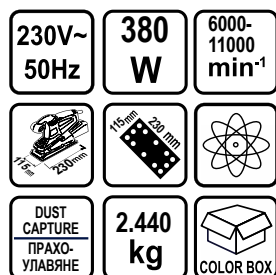
RAIDER®
Pro

Art.No	gross weight	in cartoon	barcode
040406	---	---	3800972025813

SANDER RD-SA28 BLACK EDITION

[BG] Виброшлайф • [RO] Slefuitor cu vibratii • [SR] Brusilica vibraciona • [MK] Виброшлјаферица • [RU] Шлифмашина вибрационная • [SL] Vibracijski brusilnik • [EL] Τριβείο • [HR] Jednorusna brusilica • [FR] Ponceuse électrique • [IT] Sanderia elettrica • [ES] Elektra sandero • [PT] Lixadora



Art.No	gross weight	in cartoon	barcode
040407	---	---	3800972026803

RANDOM ORBIT SANDER RD-RSA06

[BG] Екцентършлайф • [RO] Slefuitor orbital • [SR] Brusilica rotaciona • [MK] Екцентрична брусилка • [RU] Эксцентрикковые шлифовальные машины • [SL] Ekscentrični brusilnik • [EL] Εκκεντρο τρίβειο • [HR] Ekscentrična brusilica • [FR] Ponceuse excentrique • [IT] Levigatrice orbitale • [ES] Lijadora de órbita • [PT] Lixadora orbital

230V~ 50Hz	380 W
DUST CAPTURE ПРАХО-УЛАВЯНЕ	2.440 kg
	COLOR BOX
6000-11000 min ⁻¹	



Art.No	gross weight	in cartoon	barcode
040117	---	---	3800972023635

RANDOM ORBIT SANDER RD-RSA05

[BG] Екцентършлайф • [RO] Slefuitor orbital • [SR] Brusilica rotaciona • [MK] Екцентрична брусилка • [RU] Эксцентрикковые шлифовальные машины • [SL] Ekscentrični brusilnik • [EL] Εκκεντρο τρίβειο • [HR] Ekscentrična brusilica • [FR] Ponceuse excentrique • [IT] Levigatrice orbitale • [ES] Lijadora de órbita • [PT] Lixadora orbital

230V~ 50Hz	450 W
∅ 125 mm	
DUST CAPTURE ПРАХО-УЛАВЯНЕ	1.910 kg
	6000-11000 min ⁻¹



Art.No	barcode
040116	3800972016705

RANDOM ORBIT SANDER RDP-RSA03

[BG] Екцентършлайф • [RO] Slefuitor orbital • [SR] Brusilica rotaciona • [MK] Екцентрична брусилка • [RU] Эксцентрикковые шлифовальные машины • [SL] Ekscentrični brusilnik • [EL] Εκκεντρο τρίβειο • [HR] Ekscentrična brusilica • [FR] Ponceuse excentrique • [IT] Levigatrice orbitale • [ES] Lijadora de órbita • [PT] Lixadora orbital

230V~ 50Hz	420 W	6000-11000 min ⁻¹
∅ 125 mm		
DUST CAPTURE ПРАХО-УЛАВЯНЕ	1.810 kg	COLOR BOX



Art.No	gross weight	in cartoon	barcode
042102	2.220 kg	8 pcs	3800123151484

RANDOM ORBIT SANDER RDP-RSA07 BLACK EDITION

[BG] Екцентършлайф • [RO] Slefuitor orbital • [SR] Brusilica rotaciona • [MK] Екцентрична брусилка • [RU] Эксцентрикковые шлифовальные машины • [SL] Ekscentrični brusilnik • [EL] Εκκεντρο τρίβειο • [HR] Ekscentrična brusilica • [FR] Ponceuse excentrique • [IT] Levigatrice orbitale • [ES] Lijadora de órbita • [PT] Lixadora orbital

230V~ 50Hz	480 W
∅ 125 mm	
DUST CAPTURE ПРАХО-УЛАВЯНЕ	1.910 kg
	6000-11000 min ⁻¹



Art.No	barcode
040405	3800972025806

RANDOM ORBIT SANDER RDP-RSA04

[BG] Екцентършлайф • [RO] Slefuitor orbital • [SR] Brusilica rotaciona • [MK] Екцентрична брусилка • [RU] Эксцентрикковые шлифовальные машины • [SL] Ekscentrični brusilnik • [EL] Εκκεντρο τρίβειο • [HR] Ekscentrična brusilica • [FR] Ponceuse excentrique • [IT] Levigatrice orbitale • [ES] Lijadora de órbita • [PT] Lixadora orbital

230V~ 50Hz	380W
6000-13000 min ⁻¹	∅150mm
VELCRO	VARIABLE SPEED
DUST CAPTURE ПРАХО-УЛАВЯНЕ	2.200 kg
COLOR BOX	



Art.No	gross weight	in cartoon	barcode
042201	2.450 kg	6	3800123167256

BELT SANDER RD-BS09

[BG] Лентов шлайф • [RO] Slefuitor orbital • [SR] Brusilica rotaciona • [MK] Екцентрична брусилка • [RU] Шлифмашина ленточная • [SL] Ekscentrični brusilnik • [EL] Εκκεντρο τρίβειο • [HR] Ekscentrična brusilica • [FR] Ponceuse excentrique • [IT] Levigatrice orbitale • [ES] Lijadora de órbita • [PT] Lixadora orbital

230V~ 50Hz	800 W
75x475mm	380 m/min
DUST CAPTURE ПРАХО-УЛАВЯНЕ	3.655 kg
11500-32000 min ⁻¹	COLOR BOX



Art.No	gross weight	in cartoon	barcode
043107	2.450 kg	2	3800972026810

BELT SANDER RD-BS10

[BG] Лентов шлайф • [RO] Slefuitor orbital • [SR] Brusilica rotaciona • [MK] Екцентрична брусилка • [RU] Шлифмашина ленточная • [SL] Ekscentrični brusilnik • [EL] Εκκεντρο τριβείο • [HR] Ekscentrična brusilica • [FR] Ponçeuse excentrique • [IT] Levigatrice orbitale • [ES] Lijadora de órbita • [PT] Lixadora orbital



Art.No	gross weight	in cartoon	barcode
043108	2.450 kg	2	3800972026827

BELT SANDER RD-BS06

[BG] Лентов шлайф • [RO] Slefuitor electric cu banda • [SR] Vibrirajuća brusilica • [MK] Шлјаферица кружна • [RU] Шлифмашина ленточная • [SL] Tračni brusilnik • [EL] Ταϊνιολειαντήρας • [HR] Tračna brusilica • [FR] Ponçeuse à bande • [IT] Levigatrice a nastro • [ES] Litroj brusher • [PT] Lixadora



Art.No	gross weight	in cartoon	barcode
043105	4.000 kg	6 pcs	3800123158957

BELT SANDER RDP-BS07

[BG] Лентов шлайф • [RO] Slefuitor electric cu banda • [SR] Vibrirajuća brusilica • [MK] Шлјаферица кружна • [RU] Шлифмашина ленточная • [SL] Tračni brusilnik • [EL] Ταϊνιολειαντήρας • [HR] Tračna brusilica • [FR] Ponçeuse à bande • [IT] Levigatrice a nastro • [ES] Litroj brusher • [PT] Lixadora

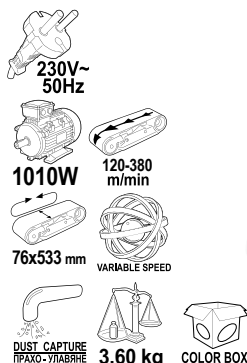

RAIDER®
Pro

Art.No	gross weight	in cartoon	barcode
043201	4.00 kg	6 pcs	3800123158940

BELT SANDER RDP-BS11

[BG] Лентов шлайф • [RO] Slefuitor electric cu banda • [SR] Vibrirajuća brusilica • [MK] Шлјаферица кружна • [RU] Шлифмашина ленточная • [SL] Tračni brusilnik • [EL] Ταϊνιολειαντήρας • [HR] Tračna brusilica • [FR] Ponçeuse à bande • [IT] Levigatrice a nastro • [ES] Litroj brusher • [PT] Lixadora

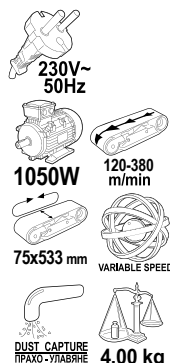

RAIDER®
Pro

Art.No	gross weight	in cartoon	barcode
043203	4.00 kg	6 pcs	3800972026889

DRYWALL SANDER RD-DS05

[BG] Шлайфмашина за стени и тавани • [RO] Slefuitor pentru pereti • [SR] Brusilice za zid i plafon • [MK] Машина За полирање на ѕидови и плафони • [RU] Машинка шлифовальная • [SL] Brusilnik za stene • [EL] Τριβείο Τοίχων Γυψοσανίδας • [HR] Zidna brusilica • [FR] Ponçeuse de cloison sèche • [IT] Levigatrice per cartongesso • [ES] Sander por muroj • [PT] Lixadora de parede



Art.No	gross weight	in cartoon	barcode
049907	5.000 kg	1 pcs	3800972009202

DRYWALL SANDER RD-DS08

[BG] Шлайфмашина за стени и тавани • [RO] Slefuitor pentru pereti • [SR] Brusilice za zid i plafon • [MK] Машина За полирање на ѕидови и плафони • [RU] Машинка шлифовальная • [SL] Brusilnik za stene • [EL] Τριβείο Τοίχων Γυψοσανίδας • [HR] Zidna brusilica • [FR] Ponçeuse de cloison sèche • [IT] Levigatrice per cartongesso • [ES] Sander por muroj • [PT] Lixadora de parede



Art.No	gross weight	in cartoon	barcode
049910	5.000 kg	1 pcs	3800972025714

DRYWALL SANDER RD-DS06

[BG] Шлайфмашина за стени и тавани • [RO] Slefuitor pentru pereti • [SR] Brusilice za zid i plafon
 • [MK] Машина За полирање на ѕидови и плафони • [RU] Машинка шлифовальная
 [SL] Brusilnik za stene • [EL] Τριβείο Τοίχων Γυψοσανίδας • [HR] Zidna brusilica • [FR] Ponceuse
 de cloison sèche • [IT] Levigatrice per cartongesso • [ES] Sander por muros • [PT] Lixadora de
 parede

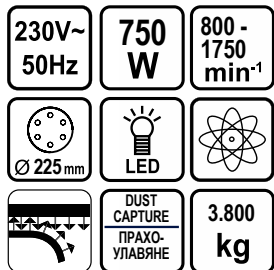

x6



DUST BAG FOR DRYWALL SANDER

Art.No	gross weight	barcode
049908	2.100 kg	3800972010178
Art.No	gross weight	barcode
049906	5.000 kg	3800972009165

DRYWALL SANDER RD-DS07

[BG] Шлайфмашина за стени и тавани • [RO] Slefuitor pentru pereti • [SR] Brusilice za zid i plafon
 • [MK] Машина За полирање на ѕидови и плафони • [RU] Машинка шлифовальная
 [SL] Brusilnik za stene • [EL] Τριβείο Τοίχων Γυψοσανίδας • [HR] Zidna brusilica • [FR] Ponceuse
 de cloison sèche • [IT] Levigatrice per cartongesso • [ES] Sander por muros • [PT] Lixadora de
 parede



Art.No	gross weight	barcode
049909	5.000 kg	3800972019737

DRYWALL SANDER RD-DS09

[BG] Шлайфмашина за стени и тавани • [RO] Slefuitor pentru pereti • [SR] Brusilice za zid i plafon
 • [MK] Машина За полирање на ѕидови и плафони • [RU] Машинка шлифовальная
 [SL] Brusilnik za stene • [EL] Τριβείο Τοίχων Γυψοσανίδας • [HR] Zidna brusilica • [FR] Ponceuse
 de cloison sèche • [IT] Levigatrice per cartongesso • [ES] Sander por muros • [PT] Lixadora de
 parede

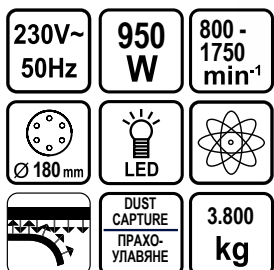

Art.No	gross weight	barcode
049911	5.000 kg	3800972027923

PAPER SANDING DISC VELCRO FOR LONG-NECK SANDERS VELCRO

[BG] Шкурка VELCRO • [RO] Benzi circulare smirghel VELCRO • [SR] Brusni papir VELCRO • [MK] Абразивна Хартија VELCRO • [RU] Бумага наждачная • [SL] Brusni platna VELCRO • [EL] Γυαλόχαρτο VELCRO • [HR] Brusni papir VELCRO • [FR] Disques à poncer VELCRO 10pcs
 • [IT] Dischi abrasivi per carta VELCRO • [ES] Discos de lija de papel VELCRO • [PT] Discos de
 lixamento de papel VELCRO

art. №	Ø (mm)	grit	barcode
180721	225	80	3800123166266
180724	225	100	3800123166723
180722	225	120	3800123166273
180723	225	150	3800123166280
180725	225	180	3800972002180

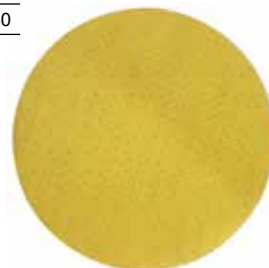
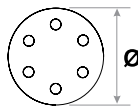

TRIANGULAR SANDING SHEETS

[BG] Шкурка VELCRO • [RO] Benzi circulare smirghel VELCRO • [SR] Brusni papir VELCRO • [MK] Абразивна Хартија VELCRO • [RU] Бумага наждачная • [SL] Brusni platna VELCRO • [EL] Γυαλόχαρτο VELCRO • [HR] Brusni papir VELCRO • [FR] Disques à poncer VELCRO 10pcs
 • [IT] Dischi abrasivi per carta VELCRO • [ES] Discos de lija de papel VELCRO • [PT] Discos de
 lixamento de papel VELCRO

art. №	Ø (mm)	grit	barcode
180726	285	80	3800972003378
180727	285	100	3800972003385
180728	285	120	3800972003392
180729	285	150	3800972003408
180730	285	180	3800972003415

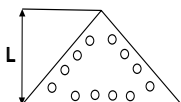

POLISHER RD-PC03

[BG] Полирмашина • [RO] Masina de polisat • [SR] Polirka ugaona • [MK] Полирка
 • [RU] Электрический полировщик • [SL] Kotni polirni stroj • [EL] Γωνιακος Λειαντης
 • [HR] Brusilica za poliranje • [FR] Polisseuse • [IT] Lucidatrice • [ES] Elektra polisilo
 • [PT] Polidora



Ø 240 mm



Art.No	gross weight	in cartoon	barcode
045101	2.650 kg	4 pcs	3800123124419

POLISHER RD-PC06

[BG] Полирмашина • [RO] Masina de polishat • [SR] Polirka ugaona • [MK] Полирка
 • [RU] Электрический полировщик • [SL] Kotni polirni stroj • [EL] Γωνιακος λειαντης
 • [HR] Brusilica za poliranje • [FR] Polisseuse • [IT] Lucidatrice • [ES] Elektra polisilo
 • [PT] Polidora

230V~ 50Hz	1400 W
300 3500 min ⁻¹	180 mm
2.100 kg	COLOR BOX



Art.No	gross weight	in cartoon	barcode
045106	2.100 kg	4 pcs	3800972026896

POLISHER RD-PC04T

[BG] Полирмашина • [RO] Masina de polishat • [SR] Polirka ugaona • [MK] Полирка
 • [RU] Электрический полировщик • [SL] Kotni polirni stroj • [EL] Γωνιακος λειαντης
 • [HR] Brusilica za poliranje • [FR] Polisseuse • [IT] Lucidatrice • [ES] Elektra polisilo
 • [PT] Polidora

230V~ 50Hz	1200 W
300 - 3000 min ⁻¹	180 mm
2.9 kg	COLOR BOX



Art.No	gross weight	in cartoon	barcode
045102	3.260 kg	2 pcs	3800123124167

BURNISHING MACHINE RDP-BM01

[BG] Шлайф ролков • [RO] Masina de polishat • [SR] Polirka • [MK] Полирка • [RU] Машина
 шлифовальная щеточная • [SL] Satinirka • [EL] Γωνιακος λειαντης • [HR] Brusilica za poliranje
 • [FR] Satineuse Trinoxflex • [IT] Satinatrice • [ES] Satinadora • [PT] Polidora

230V~ 50Hz
700-3000
2100W



Art.No	barcode
041601	3800972019676

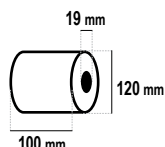

POLISHING FLEECE WHEEL
middle grit ◆◆◆◆◆



Art.No	barcode
155802	3800972019669

STRAIGHT GRINDER RDP-DG01

[BG] Прав шлайф • [RO] Polizor unghiular • [SR] Brusilica ugaona • [MK] Брусилка • [RU] Прямая
 шлифовальная машина • [SL] Brusilnik • [EL] ΤΡΟΧΟΣ • [HR] Kutna brusilica
 • [FR] Meuleuse à angle • [IT] Smerigliatrice angolare • [ES] Angulo muelillo • [PT] Rebarbadora

230V~ 50Hz	500W
0-28000	∅ 6 mm



**RAIDER®
Pro**

Art.No	barcode
041602	3800972019683

ROTARY RASP FILE 5 PCS SET

[BG] Борчета за дърво • [RO] Set 5 buc raspile pentru slefuit biax • [SR] 5-delni set gladala za drvo •
 [MK] Уметок за дрво сет 5 ком • [RU] Фреза для дерева набор 5 шт. • [SL] Rezkari komplet 5 kos • [EL] Σετ
 φρεζς 5 τετ • [HR] Nastavci za brušenje 5 kom • [FR] Baves pour le bois mis 5 pcs. • [IT] Bave per legno set 5
 pezzi • [ES] Conjunto rebabas para madera 5 uds. • [PT] Rebarbas para madeira set 5 pcs.

Art. No. 159902
 EAN: 3800123121319

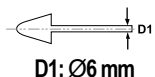

5 pcs	WOOD
-------	------



BLISTER

MOUNTED GRINDING POINT 5 PCS SET

[BG] Борчета абразивни • [RO] Set 5 buc pietre slefuit pentru bormasina • [SR] Bruni kamen set 5kom • [MK] Сет
 абразивен камен 5 ком • [RU] Каменные фрезы набор 5 шт. • [SL] Brusilni cepi komplet 5 kos • [EL] Σετ Πέτρης
 τροχιουτος από οβόλιο αργυλιου 5 τετ • [HR] Nastavci za brušenje 5 kom • [FR] Point de meulage monté, 5 pièces •
 [IT] Set di 5 pezzi per smerigliatrice montata • [ES] Juego de 5 puntos de molinda montada • [PT] Ponto de moagem
 montado 5 pcs Set

Art. No. 159903
 EAN: 3800123121104

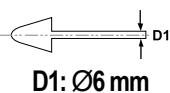

5 pcs

BLISTER

MINI GRINDER SET RD-MG07

[BG] Шлифовалка права с 40 аксесоара • [RO] Mini polizor drept • [SR] Brusilica deona 40 kom
 pribora • [MK] Рамна брусилка со додатоци • [RU] Мини шлифмашина • [SL] Mini brusilnik
 • [EL] Μινι Τροχιου • [HR] Ravna brusilica • [FR] Mini meuleuse set 40 accessoires • [IT] Mini grinder
 set 40 accessori • [ES] Mini-muelillo aro 40 aksesorajoj • [PT] Kit mini multifunções c/ 60 acessórios

230V~ 50Hz	160 W
5000- 35000 min ⁻¹	2.4 / 3.2 ∅mm
40 pcs	COLOR BOX

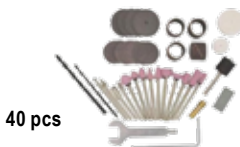

40 pcs

Art.No	gross weight	in cartoon	barcode
044105	1.020 kg	10 pcs	3800123166082

MINI GRINDER SET FLEXIBLE SHAFT RD-MG06D

[BG] Шлифовалка права с жило 210 аксесоара • [RO] Mini polizor drept • [SR] Brusilica беопа 210 ком прибора • [MK] Рамна брусилка со додатоци • [RU] Мини шлифмашина • [SL] Mini brusilnik • [EL] Μίνι Τροχέιο • [HR] Ravna brusilica • [FR] Mini meuleuse set 210 accessoires • [IT] Mini grinder set 210 accessori • [ES] Mini-mueillo aro 210аксесорајој • [PT] Kit mini multifunções c/ 210 acessórios

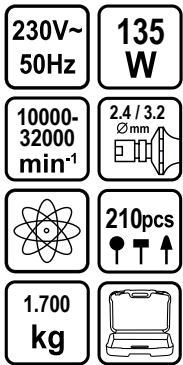

Art.No	gross weight	in cartoon	barcode
044104	2.000 kg	5 pcs	3800123124242

MINI GRINDER SET FLEXIBLE SHAFT, TOOL HOLDER RD-MG09

[BG] Шлифовалка права с жило 126 аксесоара • [RO] Mini polizor drept • [SR] Brusilica беопа 126 ком прибора • [MK] Рамна брусилка со додатоци • [RU] Мини шлифмашина • [SL] Mini brusilnik • [EL] Μίνι Τροχέιο • [HR] Ravna brusilica • [FR] Mini meuleuse set 126 accessoires • [IT] Mini grinder set 126 accessori • [ES] Mini-mueillo aro 126 аксесорајој • [PT] Kit mini multifunções c/ 126 acessórios

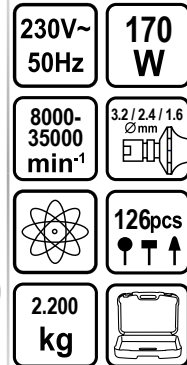

Art.No	gross weight	in cartoon	barcode
044107	2.760 kg	6 pcs	3800123170782

ACCESSORIES FOR MINI GRINDER 100PCS. SET IN CASE

[BG] Адаптер SDS-plus за патронник • [RO] Adaptor mandrina SDS-PLUS • [SR] Adapter SDS-plus • [MK] Адаптер SDS-plus за пречник • [RU] Переходник для патрона SDS-Plus • [SL] Adapter SDS-plus za vrtna glava • [EL] Στελεχος υποδοχης sds plus για τσoк • [HR] Adapter stezne glave • [FR] Adaptateur SDS-plus au mandrin • [IT] Adattatore SDS-plus a Chuck • [ES] Adaptador SDS-plus a Chuck • [PT] Adaptador SDS-plus para Chuck



Art.No	barcode
139901	3800123124969

ACCESSORIES FOR MINI GRINDER 249 PCS SET

[BG] Аксесоари за шлифовалка 249 бр. комплект • [RO] Set accesorii ptr. minipolizor - 249 buc/set • [SR] Set zacišćenje/poliranje 249 kom • [MK] Set додатоци за Рамна брусилка со осило 249 ком • [RU] Набор насадок для полировки 249 шт. • [SL] 249-delni komplet za poliranje • [EL] Σετ στίλβωσης 249 τεμ • [HR] Nastavci za brušenje 249 kom • [FR] Accessoires pour Mini Grinder 100 pcs Set • [IT] Accessori per Mini Grinder Set 100 pezzi • [ES] Accesorios para Mini Grinder 100 piezas Set • [PT] Acessórios para Mini Grinder 100 pcs Set



Art.No	barcode
138402	3800123170751

CARBIDE ENGRAVING FLAT TIP FOR RD-ENGO1

[BG] Накрайник карбиден с плосък връх • [RO] Freze pantograf proxon Carbid • [SR] Vrh za graviranje karbidni • [MK] Бит за гравирање карбид • [RU] Карбидная гравировальная насадка • [SL] Bit za graviranje • [EL] Μύτεσ χαράξης κορβιδίου • [HR] Vrh za graviranje karbidni • [FR] Pointe plate de gravure au carbure • [IT] Punta piatta per incisione in carburo • [ES] Carbide Grabado Flat Tip • [PT] Ponta plana de gravação de metal duro



Art.No	barcode
138403	3800123170768

CARBIDE ENGRAVING FLAT TIP FOR RD-ENGO1

[BG] Накрайник карбиден с плосък връх • [RO] Freze pantograf proxon Carbid • [SR] Vrh za graviranje karbidni • [MK] Бит за гравирање карбид • [RU] Карбидная гравировальная насадка • [SL] Bit za graviranje • [EL] Μύτεσ χαράξης κορβιδίου • [HR] Vrh za graviranje karbidni • [FR] Pointe plate de gravure au carbure • [IT] Punta piatta per incisione in carburo • [ES] Carbide Grabado Flat Tip • [PT] Ponta plana de gravação de metal duro



Art.No	barcode
138405	3800123173035

ENGRAVER RD-ENGO1

[BG] Уред за гравирање • [RO] Masina de gravat • [SR] Uredaj za graviranje • [MK] Апарат за гравирање • [RU] Машина для гравировки • [SL] Ročni gravirnik • [EL] Εργαλείο χαρακτικής • [HR] Alat za graviranje • [FR] Graveur • [IT] Incisore • [ES] Gravruristo • [PT] Gravadora



Art.No	gross weight	in cartoon	barcode
044108	0.500 kg	20 pcs	3800123172625

DIAMOND BURRS 20 PCS SET

[BG] Борчета диамантени 20 бр. комплект • [RO] Set 20 buc ace pentru slefuit biax • [SR] 20-delni set glodala dijamantski • [MK] Дијамантски уметок сет 20 ком • [RU] Фреза алмазная набор 20 шт. • [SL] Rezkari - dijamantni komplet 20 kos • [EL] Σετ Διαμόντια φρέζες 20 τεμ • [HR] Nastavci za brušenje dijamantni 20 kom • [FR] Jeu de 20 fraises diamantées • [IT] Diamond Burrs Set da 20 pezzi • [ES] Diamond Burrs 20 piezas Set • [PT] Diapasão 20 unidades

Art. No. 157709
EAN: 3800123121333

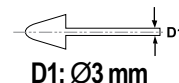

DIAMOND BURRS 30 PCS SET

[BG] Борчета диамантени 30 бр. комплект • [RO] Set 30 buc ace pentru slefuit biax • [SR] 30-delni set glodala dijamantski • [MK] Дијамантски уметок сет 30 ком • [RU] Фреза алмазная набор 30 шт. • [SL] Rezkari - dijamantni komplet 30 kos • [EL] Σετ Διαμόντια φρέζες 30 τεμ • [HR] Nastavci za brušenje dijamantni 30 kom • [FR] Set de 30 fraises diamantées • [IT] DDIAMOND Burrs Set da 30 pezzi • [ES] Diamond Burrs 30 piezas Set • [PT] Brocas de diamante 30 peças

Art. No. 157708
EAN: 3800123121340

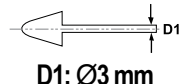

CIRCULAR SAW RD-CS24

[BG] Циркулярен ръчен • [RO] Fierastrau circular • [SR] Ručni cirkular • [MK] Циркулар рачен
• [RU] Дисковая пила • [SL] Krožna žaga • [EL] Δίσκος οπρίοιο • [HR] Ručna kružna pila
• [FR] Meuleuse d'angle • [IT] Sega circolare • [ES] Amoladora angular • [PT] Serra circular

230V~ 50Hz	480 W	4000 min ⁻¹	Ø (mm) 85 80T	27 mm (max)	1.820 kg	
---------------	----------	---------------------------	---------------------	-------------------	-------------	--



Art.No	gross weight	in cartoon	barcode
052108	3.580 kg	4 pcs	3800123166099

CIRCULAR SAW BLADE

[BG] Диск за циркуляр • [RO] Disc circular • [SR] List testere • [MK] Кружна Пила за Дрво
• [RU] Циркулярный диск • [SL] List za krožno žago • [EL] Δίσκος κοπρίοιο • [HR] Listova pila
• [FR] Lame de scie circulaire • [IT] Lama per seghe circolari • [ES] Vidita klingo • [PT] Lâmina de serra circular



art. No	Ø (mm)	D1 (mm)	D1 (ring)	teeth (pcs)	BARCODE
163137	85	10	-	30	3800123166105
163138	85	10	-	80	3800123166112

CUTTING DISC METAL

[BG] Диск за метал • [RO] Disc pentru taiat metal • [SR] Rezna ploča za metal • [MK] Диск за сечење на метал
• [RU] Отрезной диск для резки металла • [SL] Rezalne plošče - kovina • [EL] Δίσκος κοπής μετάλλου
• [HR] Ploča za rezanje metal • [FR] Disque de coupe en métal • [IT] Disco da taglio in metallo
• [ES] Trancanta Diskon Metalo • [PT] Metal de disco de corte



art. No	Ø (mm)	D1 (mm)	D2 (mm)	BARCODE
160150	85	10	1.0	3800123166129

DIAMOND CUTTING DISC DRY

[BG] Диск диамантен DRY • [RO] Disc diamantat segmentat DRY • [SR] Rezna ploča dijamantska DRY
• [MK] Дијамантски диск • [RU] Алмазный диск DRY • [SL] Diamantna rezalna plošča DRY • [EL] Κύκλοι κοπής διαμαντιών DRY
• [HR] Dijamantne ploče DRY • [FR] Disque de coupe le diamant • [IT] Diamond Disco da taglio • [ES] Tranča disko • [PT] Diamond Disco de corte



art. No	model	Ø (mm)	D1 (mm)	BARCODE
162122	-	85	10	3800123166143

DIAMOND CUTTING DISC WET

[BG] Диск диамантен WET • [RO] Disc diamantat segmentat WET • [SR] Rezna ploča dijamantska WET
• [MK] Дијамантски диск WET • [RU] Алмазный диск WET • [SL] Diamantna rezalna plošča WET • [EL] Κύκλοι κοπής διαμαντιών WET
• [HR] Dijamantne ploče WET • [FR] Disque de coupe le diamant • [IT] Diamond Disco da taglio • [ES] Tranča disko • [PT] Diamond Disco de corte



art. No	model	Ø (mm)	D1 (mm)	BARCODE
162121	CS24	85	10	3800123166136

CIRCULAR SAW BLADE METAL AND WOOD FOR RD-CS28

[BG] Диск за циркуляр за метал и дрво • [RO] Disc circular metal și lemn • [SR] List testere metal i drvo
• [MK] Кружна Пила за метал и дрво • [RU] Циркулярный диск для металл и дерево • [SL] List za krožno žago kovine in lesa
• [EL] Δίσκος κοπρίοιο μέταλλο και ξύλο • [HR] Listova pila za metal i drvo • [FR] Lame de scie circulaire métal et bois • [IT] Lama per seghe circolari in metallo e legno
• [ES] Circular Saw Blade Metalo kaj Ligno • [PT] Lâmina de serra circular de metal e madeira

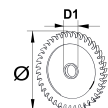

art. No	Ø (mm)	D1 (mm)	teeth	BARCODE
163139	110	20	24	3800123167560

DIAMOND CUTTING DISC WET

[BG] Диск диамантен WET • [RO] Disc diamantat segmentat WET • [SR] Rezna ploča dijamantska WET
• [MK] Дијамантски диск WET • [RU] Абразивный круг диаманта WET • [SL] Diamantna rezalna plošča WET
• [EL] Κύκλοι κοπής διαμαντιών WET • [HR] Dijamantne ploče WET • [FR] Disque de coupe le diamant • [IT] Diamond Disco da taglio • [ES] Tranča disko • [PT] Diamond Disco de corte



art. No	model	Ø (mm)	D1 (mm)	BARCODE
162123	CS25	110	20	3800123167577

CIRCULAR SAW RD-CS210

[BG] Циркулярен ръчен • [RO] Fierastrau circular • [SR] Ručni cirkular • [MK] Циркулар рачен
• [RU] Дисковая пила • [SL] Krožna žaga • [EL] Δίσκος οπρίοιο • [HR] Ručna kružna pila • [FR] Meuleuse d'angle • [IT] Sega circolare • [ES] Amoladora angular • [PT] Serra circular

230V~ 50Hz	1300 W	Ø (mm) 185x20x24T	65 mm (max)	80T	4700 min ⁻¹	0-45°	3.950 kg	LASER
---------------	-----------	----------------------	-------------------	-----	---------------------------	-------	-------------	-------



Art.No	gross weight	in cartoon	barcode
052106	3.580 kg	4 pcs	3800123159039

CIRCULAR SAW RD-CS22

[BG] Циркулярен рѣчен • [RO] Fierastrau circular • [SR] Ručni cirkular • [MK] Циркулар рачен
• [RU] Дисковая пила • [SL] Krožna žaga • [EL] Δίσκος οπρινο • [HR] Ručna kružna pila
• [FR] Meuleuse d'angle • [IT] Sega circolare • [ES] Amoladora angular • [PT] Serra circular

230V~ 50Hz	1500 W
Ø (mm) 190x20x24T 80T	70 mm (max)
4500 min ⁻¹	0-45°
4.020 kg	COLOR BOX



Art.No	gross weight	in cartoon	barcode
052201	4.760 kg	4 pcs	3800123159046

CIRCULAR SAW RDP-CS26X

[BG] Циркулярен рѣчен • [RO] Fierastrau circular • [SR] Ručni cirkular • [MK] Циркулар рачен
• [RU] Дисковая пила • [SL] Krožna žaga • [EL] Δίσκος οπρινο • [HR] Ručna kružna pila
• [FR] Meuleuse d'angle • [IT] Sega circolare • [ES] Amoladora angular • [PT] Serra circular

230V~ 50Hz	1400W	4700min ⁻¹
65 mm (max)	Ø (mm) 190x20	0-45°
0-45°	4.16 kg	COLOR BOX



RAIDER[®]
Pro

Art.No	gross weight	in cartoon	barcode
052110	4.320 kg	4 pcs	3800123167621

CIRCULAR SAW RDP-CS30

[BG] Циркулярен рѣчен • [RO] Fierastrau circular • [SR] Ručni cirkular • [MK] Циркулар рачен
• [RU] Дисковая пила • [SL] Krožna žaga • [EL] Δίσκος οπρινο • [HR] Ručna kružna pila
• [FR] Meuleuse d'angle • [IT] Sega circolare • [ES] Amoladora angular • [PT] Serra circular

230V~ 50Hz	1800 W
Ø (mm) 200x20x24T 80T	70 mm (max)
5500 min ⁻¹	0-45°
7.68 kg	COLOR BOX



RAIDER[®]
Pro

Art.No	gross weight	in cartoon	barcode
052130	7.68 kg	4 pcs	3800972024380

PLANER RD-EP16

[BG] Ренде електрическо • [RO] Rindea electrica • [SR] Električno rende • [MK] Рачен абрихтер
• [RU] Рубанок • [SL] Utorni oblič • [EL] Ηλεκτρική πλάνη • [HR] Jednoručna blanja • [FR] Rabot
électrique [IT] Piatta elettrica • [ES] Elektra ebenajo • [PT] Plaina eléctrica

230V~ 50Hz	710 W	16 000 min ⁻¹
0-12mm	0-2 mm	82 mm
DUST CAPTURE ПРАХО-УЛАВЯНЕ	2.9 kg	COLOR BOX



Art.No	gross weight	in cartoon	barcode
055106	3.260 kg	6 pcs	3800972026834

PLANER RD-EP130

[BG] Ренде електрическо • [RO] Rindea electrica • [SR] Električno rende • [MK] Рачен абрихтер
• [RU] Рубанок • [SL] Utorni oblič • [EL] Ηλεκτρική πλάνη • [HR] Jednoručna blanja • [FR] Rabot
électrique [IT] Piatta elettrica • [ES] Elektra ebenajo • [PT] Plaina eléctrica

230V~ 50Hz	710 W	16 000 min ⁻¹
0-12mm	0-2 mm	82 mm
DUST CAPTURE ПРАХО-УЛАВЯНЕ	2.9 kg	COLOR BOX



Art.No	gross weight	in cartoon	barcode
055105	3.260 kg	6 pcs	3800123158933

PLANER RD-EP12

[BG] Ренде електрическо • [RO] Rindea electrica • [SR] Električno rende • [MK] Рачен абрихтер
• [RU] Рубанок • [SL] Utorni oblič • [EL] Ηλεκτρική πλάνη • [HR] Jednoručna blanja • [FR] Rabot
électrique [IT] Piatta elettrica • [ES] Elektra ebenajo • [PT] Plaina eléctrica

230V~ 50Hz	850 W	16 000 min ⁻¹
0-12.5mm	0-3 mm	82 mm
DUST CAPTURE ПРАХО-УЛАВЯНЕ	3.1 kg	COLOR BOX



Art.No	gross weight	in cartoon	barcode
055201	3.500 kg	6 pcs	3800123158926

PLANER RDP-EP15

[BG] Ренде електрическо • [RO] Rindea electrica • [SR] Električno rende • [MK] Рачен абрихтер • [RU] Рубанок • [SL] Utorni oblič • [EL] Ηλεκτρική πλάνη • [HR] Jednoručna blanja • [FR] Rabot électrique [IT] Pialla elettrica • [ES] Elektra ebenajo • [PT] Plaina eléctrica

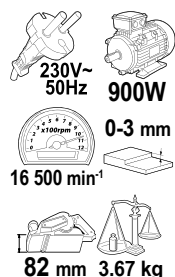
RAIDER®
Pro

Art.No	gross weight	in cartoon	barcode
055202	4.650 kg	4 pcs	3800972016378

PLANER RDP-EP10S

[BG] Ренде електрическо • [RO] Rindea electrica • [SR] Električno rende • [MK] Рачен абрихтер • [RU] Рубанок • [SL] Utorni oblič • [EL] Ηλεκτρική πλάνη • [HR] Jednoručna blanja • [FR] Rabot électrique [IT] Pialla elettrica • [ES] Elektra ebenajo • [PT] Plaina eléctrica

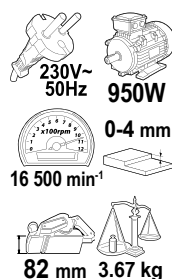
RAIDER®
Pro

Art.No	gross weight	in cartoon	barcode
055102	4.080 kg	6 pcs	3800123122927

REVERSIBLE BLADES FOR PLANERS 82MM 2 PCS. SET FOR RD-EP09, 10 & 11

[BG] Ножове за ренде ел. 2 бр. комплект • [RO] Set 2 buc Lame pentru rindea electrica • [SR] Set Noževa za Električna Hoblarica 2 kom. • [MK] Нож за електрично ренде сет 2 бр • [RU] Нож за Электрический станок набор 2 шт • [SL] Electric planer nož kit 2 kosa • [EL] Ηλεκτρικό μηχανήμα μαχαίρι сет 2 τεμάχια • [HR] Nož blanje 2 kom • [FR] Lames réversibles pour raboteuses 82mm 2 pcs • [IT] Lame reversibili per piallatrici 82mm 2 pz • [ES] Reversibles klingoj por planantoj 82mm 2 PC • [PT] Láminas reversíveis para plainas 82mm 2 peças



art. №	length/mm	pcs	BARCODE
209937	82	2	3800123104800

ROUTER RD-ER07

[BG] Оберфреза • [RO] Freza electrica • [SR] Glodalica • [MK] Фреза • [RU] Фрезер • [SL] Nadrezkar • [EL] Ηλεκτρικό router • [HR] Vertikalna glodalica • [FR] Électrique scie sauteuse • [IT] Router elettrico • [ES] Elektra router • [PT] Roteador elétrico

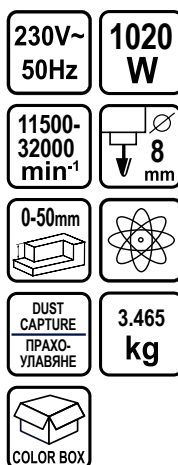

Art.No	gross weight	in cartoon	barcode
051102	4.260 kg	4 pcs	3800123124518

ROUTER RDP-ER13

[BG] Оберфреза • [RO] Freza electrica • [SR] Glodalica • [MK] Фреза • [RU] Фрезер • [SL] Nadrezkar • [EL] Ηλεκτρικό router • [HR] Vertikalna glodalica • [FR] Électrique scie sauteuse • [IT] Router elettrico • [ES] Elektra router • [PT] Roteador elétrico

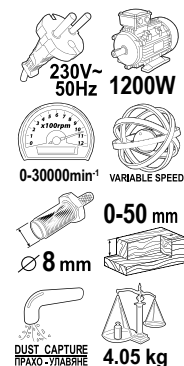
RAIDER®
Pro

Art.No	gross weight	in cartoon	barcode
051108	4.500 kg	4 pcs	3800123162510



ROUTER TABLE RD-RT01

[BG] Маса работна за обертфреза • [RO] Masa pentru frezare • [SR] Radni sto za glodalica • [MK] Masa работна за фрезер • [RU] Фрезеровочный стол • [SL] Delovna miza za nadrezkar • [EL] Τραπέζι ρούτερ • [HR] Radni stol za glodalica • [FR] Table de routeur • [IT] Tavolo del router • [ES] Router-tablo • [PT] Mesa de fresa

230V~
50Hz

Main Table

400 mm 335 mm

Extension Table

200 mm 255 mm

COLOR BOX



Art.No	gross weight	in cartoon	barcode
059907	6.500 kg	4 pcs	3800123123467

HINGE HOLE CUTTER

[BG] Фрезер за отвор • [RO] Freza ptr balamale • [SR] Glodalo • [MK] Глодал • [RU] Зенкер для пробок • [SL] Rezkar za luknjo • [EL] Φρεζων • [HR] Glodalo za utore, bočna • [FR] Charnière trou cutter • [IT] Cerniera per cerniere • [ES] Hinge Hole Cutter • [PT] Cortador De Furo De Dobradiça



art. №	D1 (mm)	BARCODE
154601	Ø15	3800123121258
154602	Ø20	3800123121265
154603	Ø25	3800123121272
154604	Ø30	3800123121289
154605	Ø35	3800123121296
154606	Ø40	3800123121302

HINGE CUTTING BITS TUNGSTEN CARBIDE TIPPED 5 PCS SET

[BG] Фрезери за отвори с твърдосплавни пластини Ø15,20,25,30 и 35mm 5бр. к-т • [RO] 5 Pcs/ Set freze ptr balamale • [SR] Glodala set 5 kom • [MK] Глодалки сет 5 ком • [RU] Зенкеры для пробок набор 5 шт • [SL] Rezkar za luknjo 5 kos • [EL] Σετ φρεζων 5 τεμ • [HR] 5-djelni set glodala • [FR] Charnière trou cutter • [IT] Cerniera per cerniere • [ES] Hinge Hole Cutter • [PT] Cortador De Furo De Dobradiça

Ø15-35mm

CUTTERS D1:Ø15, 20, 25, 30, 35mm

Art. No. 157502

EAN: 3800123121210



5 pcs

ROUTER BIT

[BG] Фрезер за обертфреза • [RO] Freza profilata • [SR] Glodalo • [MK] Глодало • [RU] Зенкер • [SL] Rezkar • [EL] Φρεζων • [HR] Glodalo za utore, bočna / ravna • [FR] Peu de routeur • [IT] Bit del router • [ES] Router Bito • [PT] Bit Router

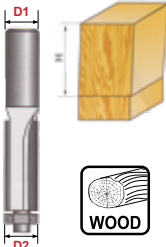

art. №	D2 Ø mm	D1/mm	H/mm	BARCODE
154405	Ø 9.5	Ø 8	38	3800123169700
154402	Ø 12.7	Ø 8	25	3800123121531
154406	Ø 12.7	Ø 8	50.8	3800123169717



art. №	D2 Ø mm	D1/mm	H/mm	BARCODE
154401	Ø 15.9	Ø 8	20	3800123121548

ROUTER BIT

[BG] Фрезер за обертфреза • [RO] Freza profilata • [SR] Glodalo • [MK] Глодало • [RU] Зенкер • [SL] Rezkar • [EL] Φρεζων • [HR] Glodalo za utore, bočna / ravna • [FR] Peu de routeur • [IT] Bit del router • [ES] Router Bito • [PT] Bit Router



art. №	D2 Ø mm	D1/mm	H/mm	BARCODE
154409	Ø 31.75	Ø 8	6.35	3800123169748



art. №	D2 Ø mm	D1/mm	R/mm	B/mm	H/mm	BARCODE
154407	Ø 17.46	Ø 8	2.38	2.38	6.5	3800123169724

ROUTER BIT

[BG] Фрезер за обертфреза • [RO] Freza profilata • [SR] Glodalo • [MK] Глодало • [RU] Зенкер • [SL] Rezkar • [EL] Φρεζων • [HR] Glodalo za utore, bočna / ravna • [FR] Peu de routeur • [IT] Bit del router • [ES] Router Bito • [PT] Bit Router



art. №	D2 Ø mm	D1/mm	R/mm	B/mm	H/mm	BARCODE
154404	Ø 25.7	Ø 8	6.35	6.35	9.52	3800123121524



art. №	Ø mm	D1/mm	D2/mm	R/mm	B/mm	H/mm	BARCODE
154408	Ø 31.7	Ø 8	31.7	9.52	9.52	15.9	3800123169731

ROUTER BIT

[BG] Фрезер за обертфреза • [RO] Freza profilata • [SR] Glodalo • [MK] Глодало • [RU] Зенкер
• [SL] Rezkar • [EL] Φρεζωון • [HR] Glodalo za utore, bočna / ravna • [FR] Peu de routeur • [IT] Bit
del router • [ES] Router Bito • [PT] Bit Router



art. №	D2 Ø mm	D1/mm	B/mm	BARCODE
154403	Ø 30.96	8	12.7	3800123121555

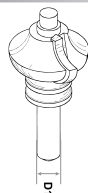

art. №	D1 Ø mm	BARCODE
158301	Ø 8	3800123121500

ROUTER BIT

[BG] Фрезер за обертфреза • [RO] Freza profilata • [SR] Glodalo • [MK] Глодало • [RU] Зенкер
• [SL] Rezkar • [EL] Φρεζωון • [HR] Glodalo za utore, bočna / ravna • [FR] Peu de routeur • [IT] Bit
del router • [ES] Router Bito • [PT] Bit Router

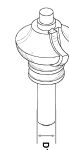

art. №	Ø D1/mm	BARCODE
158302	8	3800123121517

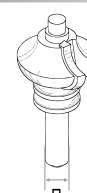

art. №	Ø D1/mm	BARCODE
158303	8	3800123121630

ROUTER BIT

[BG] Фрезер за обертфреза • [RO] Freza profilata • [SR] Glodalo • [MK] Глодало • [RU] Зенкер
• [SL] Rezkar • [EL] Φρεζωון • [HR] Glodalo za utore, bočna / ravna • [FR] Peu de routeur • [IT] Bit
del router • [ES] Router Bito • [PT] Bit Router

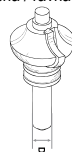

art. №	Ø D1/mm	BARCODE
158304	8	3800123121241

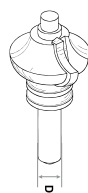

art. №	Ø D1/mm	BARCODE
158305	8	3800123121678

BISCUIT JOINTER RD-BJ01

[BG] Фреза за плоски дибли (Бисквит Машина) • [RO] Freză pentru dibluri plate • [SR] Glodalica
Za žljebove • [MK] Глодалка за жлеbove • [RU] Фрезы для плоских шкантов • [SL] Lamelni
rezkalnik • [EL] Φρεζοκαβλιέρα [HR] Glodalica za utore • [FR] Fraises pour chevilles plates
• [IT] Frese per tasselli piatti • [ES] Tranchío por ebenaj dokaloj • [PT] Tupia angular

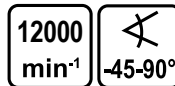
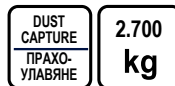
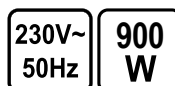

Art.No	gross weight	in cartoon	barcode
059906	6.000 kg	4 pcs	3800123123443

DISC FOR BISCUIT JOINTER

[BG] Диск за фреза за плоски дибли (Бисквит Машина) • [RO] Disc pentru masina de frezat -
dibluri plate • [SR] Rezna ploča za glodalica za žljebove • [MK] Диск за глодалка за жлеbove
• [RU] Отрезной диск для фрезы для плоских шкантов • [SL] Rezalne plošče za lamelni rez-
kalnik • [EL] Δίσκος κοπής Φρεζοκαβλιέρα • [HR] Ploča za rezanje za Glodalica Za Uture
• [FR] Disque de coupe pour le moulin pour goujons plats • [IT] Disco da taglio per il mulino per
tasselli piatti • [ES] Trancha disco por la Muelejo por Platformaj Dokaloj • [PT] Disco de corte para o
moinho para buchas planas

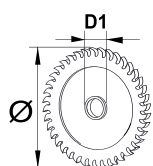

art. №	Ø (mm)	D1 (mm)	Thickness/ mm	teeth	BARCODE
163141	100	22.2 (20)	4	6	3800123167553



ELECTRIC STAPLER RD-ES15

[BG] Такер електрически комбиниран • [RO] Capsator electric • [SR] Heftalica električna • [MK] Хефталица електрична • [RU] Электрический степлер • [SL] Električni spenjalnik • [EL] Ηλεκτρικό Συρραπτικό • [HR] Pištolj za klamerice • [FR] Agrafeuse électrique • [IT] Cucitrice meccanica elettrica • [ES] Elektra grapilo • [PT] Agrafador elétrico

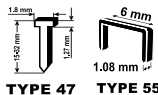
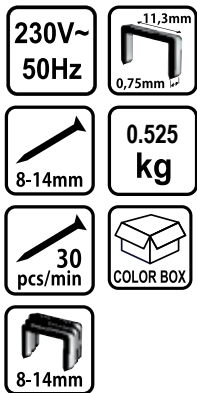

Art.No	gross weight	in cartoon	barcode
129998	0.860 kg	10 pcs	3800123133725

ELECTRIC STAPLER RD-ES16

[BG] Такер електрически комбиниран • [RO] Capsator electric • [SR] Heftalica električna • [MK] Хефталица електрична • [RU] Электрический степлер • [SL] Električni spenjalnik • [EL] Ηλεκτρικό Συρραπτικό • [HR] Pištolj za klamerice • [FR] Agrafeuse électrique • [IT] Cucitrice meccanica elettrica • [ES] Elektra grapilo • [PT] Agrafador elétrico

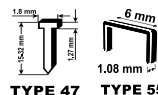

Art.No	gross weight	in cartoon	barcode
059601	1.560 kg	10 pcs	3800123167959

WET AND DRY VACUUM CLEANER RD-WC08

• [BG] Прахосмукачка за сухо и мокро • [RO] Aspirator umed/uscat • [SR] Usisivača za mokro i suvo • [MK] Правосмукалка за суво и мокро • [RU] Мокрый и сухой пылесос • [SL] Sesalnik za mokro in suho • [EL] Ηλεκτρική σκούπα για υγρή και ξηρή • [HR] Usisavač za mokre i suhe podloge • [FR] Aspirateur humide et sec • [IT] Aspirapolvere a umido ea secco • [ES] Malseka kaj seka malplena • [PT] Aspirador "WET & DRY"

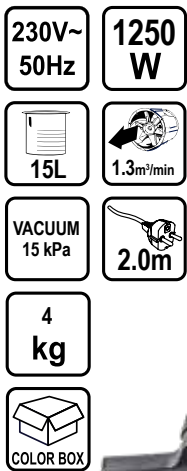

Art.No	gross weight	barcode
090317	4.900 kg	3800972015869

WET AND DRY VACUUM CLEANER RD-WC09

• [BG] Прахосмукачка за сухо и мокро • [RO] Aspirator umed/uscat • [SR] Usisivača za mokro i suvo • [MK] Правосмукалка за суво и мокро • [RU] Мокрый и сухой пылесос • [SL] Sesalnik za mokro in suho • [EL] Ηλεκτρική σκούπα για υγρή και ξηρή • [HR] Usisavač za mokre i suhe podloge • [FR] Aspirateur humide et sec • [IT] Aspirapolvere a umido ea secco • [ES] Malseka kaj seka malplena • [PT] Aspirador "WET & DRY"

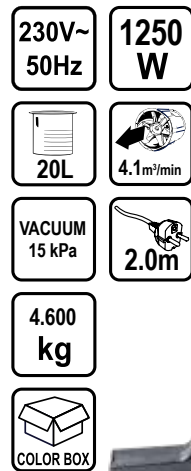

Art.No	gross weight	barcode
090318	5.500 kg	3800972015876

WET AND DRY VACUUM CLEANER RD-WC10

• [BG] Прахосмукачка за сухо и мокро • [RO] Aspirator umed/uscat • [SR] Usisivača za mokro i suvo • [MK] Правосмукалка за суво и мокро • [RU] Мокрый и сухой пылесос • [SL] Sesalnik za mokro in suho • [EL] Ηλεκτρική σκούπα για υγρή και ξηρή • [HR] Usisavač za mokre i suhe podloge • [FR] Aspirateur humide et sec • [IT] Aspirapolvere a umido ea secco • [ES] Malseka kaj seka malplena • [PT] Aspirador "WET & DRY"

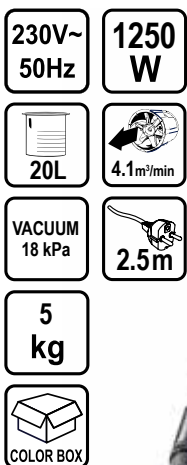

Art.No	gross weight	barcode
090321	5.500 kg	3800972015913

WET AND DRY VACUUM CLEANER RD-WC07

[BG] Прахосмукачка за сухо и мокро • [RO] Aspirator umed/uscat • [SR] Usisivača za mokro i suvo • [MK] Правосмукалка за суво и мокро • [RU] Мокрый и сухой пылесос • [SL] Sesalnik za mokro in suho • [EL] Ηλεκτρική σκούπα για υγρή και ξηρή • [HR] Usisavač za mokre i suhe podloge • [FR] Aspirateur humide et sec • [IT] Aspirapolvere a umido ea secco • [ES] Malseka kaj seka malplena • [PT] Aspirador "WET & DRY"

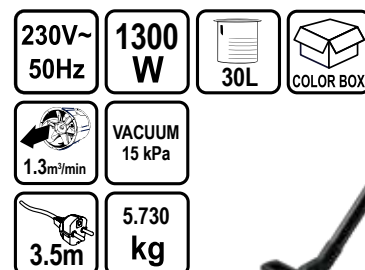

VACUUM CLEANER BAGS
SET FOR RD-WC07



Art.No	barcode
090328	3800972024311



Art.No	gross weight	in cartoon	barcode
090316	6.100 kg		3800972015852

WET AND DRY VACUUM CLEANER RDP-WC04

[BG] Прахосмукачка за сухо и мокро • [RO] Aspirator umed/uscat • [SR] Usisivača za mokro i suvo • [MK] Правосмукалка за суво и мокро • [RU] Мокрый и сухой пылесос • [SL] Sesalnik za mokro in suho • [EL] Ηλεκτρική σκούπα για υγρή και ξηρή • [HR] Usisivač za mokre i suhe podloge • [FR] Aspirateur humide et sec • [IT] Aspirapolvere a umido ea secco • [ES] Malseka kaj seka malplena [PT] Aspirador "WET & DRY"

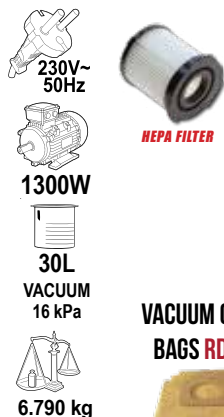

VACUUM CLEANER
BAGS RD-WC04



INOX

RAIDER®
PRO

Art.No	gross weight	barcode
090312	0.120 kg	3800972014978

Art.No	gross weight	barcode
090310	7.300 kg	3800972012622

ASH VACUUM CLEANER RD-WC06

[BG] Прахосмукачка за пепел • [RO] Aspirator pentru cenusa • [SR] Usisivač za pepeo • [MK] Правосмукалка за пепел • [RU] Пепла пылесос • [SL] Sesalnik pepela • [EL] Σκούπα φίλτρο σταχτήσ • [HR] Usisivač za uklanjanje pepela • [FR] Aspirateur de cendre • [IT] Aspirapolvere per cenere • [ES] Ash malplena • [PT] Aspirador de cinzas



Art.No	gross weight	barcode
090314	3.800 kg	3800972015838

ASH VACUUM CLEANER RD-WC02

[BG] Прахосмукачка за пепел • [RO] Aspirator pentru cenusa • [SR] Usisivač za pepeo • [MK] Правосмукалка за пепел • [RU] Пепла пылесос • [SL] Sesalnik pepela • [EL] Σκούπα φίλτρο σταχτήσ • [HR] Usisivač za uklanjanje pepela • [FR] Aspirateur de cendre • [IT] Aspirapolvere per cenere • [ES] Ash malplena • [PT] Aspirador de cinzas

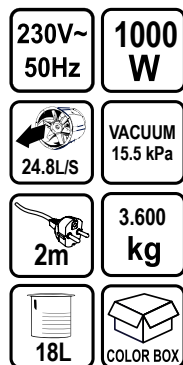

Art.No	gross weight	in carton	barcode
090304	4.300 kg	1	3800123173448

ASH VACUUM CLEANER RD-WC05

[BG] Прахосмукачка за пепел • [RO] Aspirator pentru cenusa • [SR] Usisivač za pepeo • [MK] Правосмукалка за пепел • [RU] Пепла пылесос • [SL] Sesalnik pepela • [EL] Σκούπα φίλτρο σταχτήσ • [HR] Usisivač za uklanjanje pepela • [FR] Aspirateur de cendre • [IT] Aspirapolvere per cenere • [ES] Ash malplena • [PT] Aspirador de cinzas



Art.No	gross weight	in carton	barcode
090313	4.300 kg	1	3800972015821

ASH VACUUM CLEANER RD-WC03

[BG] Прахосмукачка за пепел • [RO] Aspirator pentru cenusa • [SR] Usisivač za pepeo • [MK] Правосмукалка за пепел • [RU] Пепла пылесос • [SL] Sesalnik pepela • [EL] Σκούπα φίλτρο σταχτήσ • [HR] Usisivač za uklanjanje pepela • [FR] Aspirateur de cendre • [IT] Aspirapolvere per cenere • [ES] Ash malplena • [PT] Aspirador de cinzas

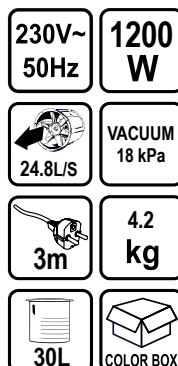

Art.No	gross weight	in carton	barcode
090308	5.000 kg	1	3800972008823

HEPA FILTER FOR METAL ASH CLEANER

[BG] HEPA филтър • [RO] Filtru HEPA • [SR] HEPA filter • [MK] HEPA филтер • [RU] HEPA фильтр • [SL] HEPA filter • [EL] Φίλτρο HEPA • [HR] HEPA filter • [FR] Filtre HEPA • [IT] Filtro HEPA • [ES] HEPA-filtrilo • [PT] Filtro HEPA



art. №	L (capacity)	BARCODE
090307 for metal container	18	3800972003316

HEPA FILTER FOR VACUUM CLEANER

[BG] HEPA филтър • [RO] Filtru HEPA • [SR] HEPA filter • [MK] HEPA филтер • [RU] HEPA фильтр • [SL] HEPA filter • [EL] Φίλτρο HEPA • [HR] HEPA filter • [FR] Filtre HEPA • [IT] Filtro HEPA • [ES] HEPA-filtro • [PT] Filtro HEPA



art. №	L (mm)	Ø mm	BARCODE
090305 for RD-WC02	108	123	3800123173684
090327 for RD-WC02N	120	100	3800972023666
090309 for RD-WC03	120	100	3800972008830
090311 for RD-WC04	107	137	3800972012639

MITRE SAW TABLE SAW RD-TS20

[BG] Циркулар настолен с двустранно наклоняне • [RO] Ferestrau circular • [SR] Pokretna kružna testera • [MK] Циркулар столен • [RU] Торцовочная пила • [SL] Radialna zajeralna žaga • [EL] Ηδίσκοπριόνο για ξύλο • [HR] Kružna pila • [FR] Scie à onglet • [IT] Formare sega • [ES] Formando sa • [PT] Serra de esquadria



Art.No	gross weight	barcode
054105	11.000 kg	3800123159220

MITRE SAW TABLE SAW RD-MS02

[BG] Циркулар настолен с двустранно наклоняне • [RO] Ferestrau circular • [SR] Pokretna kružna testera • [MK] Циркулар столен • [RU] Торцовочная пила • [SL] Radialna zajeralna žaga • [EL] Ηδίσκοπριόνο για ξύλο • [HR] Kružna pila • [FR] Scie à onglet • [IT] Formare sega • [ES] Formando sa • [PT] Serra de esquadria



Art.No	gross weight	barcode
053100	6.500 kg	3800123154690

MITRE SAW TABLE SAW RD-MS21

[BG] Циркулар настолен с двустранно наклоняне • [RO] Ferestrau circular • [SR] Pokretna kružna testera • [MK] Циркулар столен • [RU] Торцовочная пила • [SL] Radialna zajeralna žaga • [EL] Ηδίσκοπριόνο για ξύλο • [HR] Kružna pila • [FR] Scie à onglet • [IT] Formare sega • [ES] Formando sa • [PT] Serra de esquadria

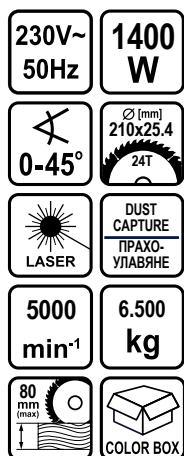

Art.No	gross weight	barcode
053102	8.000 kg	3800123123856

MITRE SAW TABLE SAW RD-MS06

[BG] Циркулар настолен с двустранно наклоняне • [RO] Ferestrau circular • [SR] Pokretna kružna testera • [MK] Циркулар столен • [RU] Торцовочная пила • [SL] Radialna zajeralna žaga • [EL] Ηδίσκοπριόνο για ξύλο • [HR] Kružna pila • [FR] Scie à onglet • [IT] Formare sega • [ES] Formando sa • [PT] Serra de esquadria

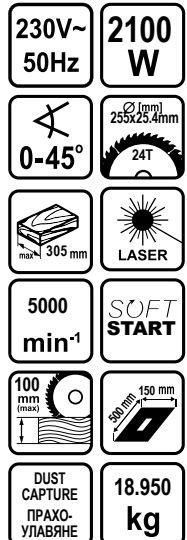

Art.No	gross weight	barcode
053104	20.000 kg	3800123123156

MITRE SAW DOUBLE BEWEL RDP-MS11

[BG] Циркулар настолен с двустранно наклоняне • [RO] Ferestrau circular • [SR] Pokretna kružna testera • [MK] Циркулар столен • [RU] Торцовочная пила • [SL] Radialna zajeralna žaga • [EL] Ηδίσκοπριόνο για ξύλο • [HR] Kružna pila • [FR] Scie à onglet • [IT] Formare sega • [ES] Formando sa • [PT] Serra de esquadria

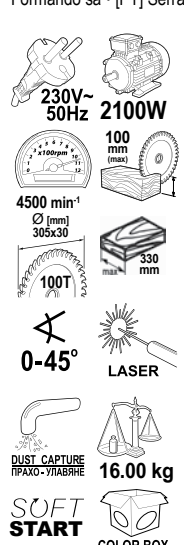

Art.No	gross weight	in cartoon	barcode
053108	20.000 kg	1	3800972010109

MITRE SAW DOUBLE BEVEL RDP-MS12

[BG] Циркуляр настолен с двустранно наклоняне • [RO] Fereastră circular • [SR] Pokretna kružna testera • [MK] Циркулар столен • [RU] Торцовочная пила • [SL] Radialna zajezalna žaga • [EL] Ηδίσκοπριονο για ξύλο • [HR] Kružna pila • [FR] Scie à onglet • [IT] Formare sega • [ES] Formando sa • [PT] Serra de esquadria

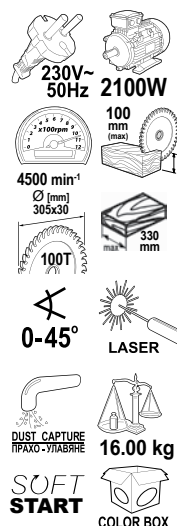

Art.No	gross weight	in cartoon	barcode
053109	20.000 kg	1	3800972027916

COMBINATION TABLE AND MITRE SAW RD-MS10

[BG] Циркуляр настолен комбиниран • [RO] Fierastră circular semi-stacionar si de masa • [SR] Testera kružna kombinovana stacionarna • [MK] Циркулар за дрво столен • [RU] Торцовочная пила • [SL] Radialna zajezalna žaga • [EL] Δίσκοπριονο Για Ξύλο • [HR] Potezno-nagibna pila • [FR] Banc de scie • [IT] Sega da tavolo • [ES] Tablo vidis • [PT] Serra de esquadria



Art.No	gross weight	in cartoon	barcode
054104	12.060 kg	1	3800123141911



BAND SAW RD-BSW18

[BG] Банциг • [RO] Fereastră pendular de banc • [SR] Trakasta testera • [MK] Трачна пила • [RU] Ленточная пила • [SL] Tračna žaga • [EL] Πριονοκορδέλα • [HR] Трачна пила • [FR] Scie à ruban • [IT] Sega a nastro • [ES] Bando vidis • [PT] Serra de mesa

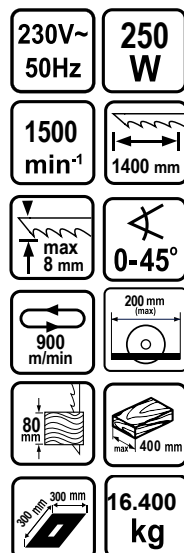

**BAND SAW BLADE
FOR RD-BSW18**



Art. No. 155701
EAN: 3800123162183

Art.No	gross weight	in cartoon	barcode
059902	18.500 kg	1	3800123162176

WOOD LATHE RD-WL03T

[BG] Струг за дърво • [RO] Strung pentru lemn • [SR] Glodalica za drvo • [MK] Струг за дрво • [RU] Токарный станок по дереву • [SL] Lesna stružnica • [EL] Ξυλουργικός τόρνος • [HR] Tokarilica za drvo • [FR] Tour à bois • [IT] Tornio di legno • [ES] Tornilo de ligno • [PT] Torno p/ madeira



Art.No	gross weight	barcode
059905	24.000 kg	3800123124952

SCROLL SAW RD-SS16J

[BG] Машина за изрязване на орнаменти • [RO] Fereastră de banc • [SR] Tračna testera • [MK] Машина за изрязување на украси • [RU] Выделителе пила • [SL] Električna rezbarska žaga • [EL] Πριονοκορδέλες • [HR] Stroj za rezanje ornamentima • [FR] Scie à chantourner • [IT] Scorri sega • [ES] Scroll vidis • [PT] Serra de rolagem

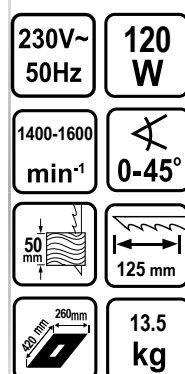

Art.No	gross weight	in cartoon	barcode
059903	15.000 kg		3800123124945

SCROLL SAW BLADE 2 PCS SET

[BG] Нож за машина за орнаменти 2 броя комплект • [RO] set 2 buc lama pentru fierastrau de banc • [SR] List testere za tračna testera 2 kom Set • [MK] Нож за машина за изражување на украси 2 парчиња • [RU] Пильное полотно для выделите пила 2 шт набор • [SL] Žagin list za električna rezbarska žaga 2 kosa • [EL] Приονόλαμες σέγας για приονοκρόδελος Σετ 2 τεμ • [HR] Nož za stroj za rezanje ornamentima 2 kom • [FR] Jeu de 2 lames de scie à chantourner • [IT] Lama per sega a scorporimento Set 2 pezzi • [ES] Blade por vidi 2 komputilojn. Kit • [PT] Lámina para serra 2 unidades



art. №	length/mm	pcs	barcode
209912	127	2	3800123107627

TABLE SAW WITH EXTENSION WINGS AND STAND RD-TS12B

[BG] Циркулар стационарен • [RO] Fierastrau circular de banc • [SR] Testera kružna stacionarna • [MK] Потезна-комбинирана пила • [RU] Настольная пила • [SL] Stabilina in kotna žaga • [EL] Δισκοπριονο • [HR] Stolna kružna pila • [FR] Scie à table avec rallonges et support • [IT] Sega da tavolo con ali di estensione e supporto • [ES] Tablo vidis per etendaj flugiloj kaj staras • [PT] Serra circular de bancada c/ abas extensíveis e suporte

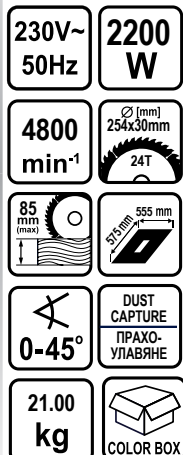

Art.No	gross weight	barcode
059403	25.600 kg	3800123160738

COMBINED WOODWORKING MACHINE RDP-CWM01

[BG] Машина дървообработваща мултифункционална • [RO] Masina combinata pentru tamplarie • [SR] Kombinovana mašina za obradu drveta • [MK] Комбинирана машина за дрво • [RU] Настольная пила • [SL] Stabilina in kotna žaga • [EL] Δισκοπριονο • [HR] Višenamjenski stroj za drvo • [FR] Machine à bois combinée • [IT] Macchina per la lavorazione del legno combinata • [ES] Combinata lignaj mašinoj • [PT] Máquina universal p/ carpintaria



Awarded with a gold medal

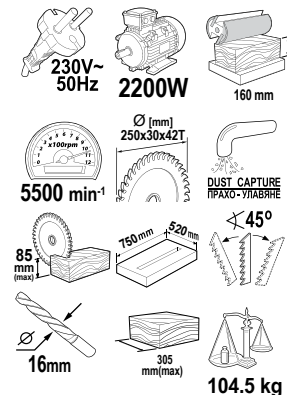

KNIFE FOR PLANNER 2 PCS SET

art. №	length/mm	pcs	BARCODE
155501	250	2	3800123162060
155504	305	2	3800123171215

CIRCULAR OPTION



PLANING OPTION



DRILL OPTION



Art.No	gross weight	in cartoon	barcode
059402	108.500 kg		3800123158995

BENCH THICKNESSER RDP-BPT01

[BG] Щрайхмус

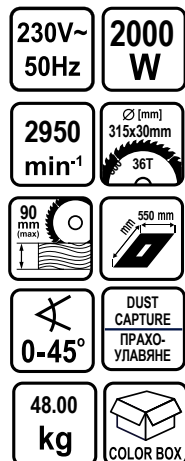

Art.No	gross weight	barcode
059404	--- kg	3800972026513

BLADES FOR THICKNESSER RDP-BPT01 2PCS. SET

[BG] Ножове за щрайхмус

Art.No	gross weight	barcode
155505	--- kg	3800972026520

TABLE SAW WITH EXTENSION WINGS AND STAND RD-TS10

[BG] Циркулар стационарен • [RO] Fierastrau circular de banc • [SR] Testera kružna stacionarna • [MK] Потезна-комбинирана пила • [RU] Настольная пила • [SL] Stabilina in kotna žaga • [EL] Δισκοπριονο • [HR] Stolna kružna pila • [FR] Scie à table avec rallonges et support • [IT] Sega da tavolo con ali di estensione e supporto • [ES] Tablo vidis per etendaj flugiloj kaj staras • [PT] Serra circular de bancada c/ abas extensíveis e suporte



Art.No	gross weight	barcode
053105	52.000 kg	3800123123207

DUST COLLECTOR RD-DCO1Q

- [BG] Прахоуловител • [RO] Aspirator de praf • [SR] Skupljač Prašine
- [MK] Правосмукалак • [RU] Пыле уловитель • [SL] Industrijski sesalnik
- [EL] Απορροφητήρας Σκονής • [HR] Usisavač za prašinu
- [FR] Collecteur de poussière • [IT] Aspirapolvere
- [ES] Polva kolektanto • [PT] Saco p/ lixadora de parede

230V~ 50Hz	750 W
1400 m ³ /h	 80L
2950 min ⁻¹	 102mm
20.950 kg	 COLOR BOX





- **Асинхронен електрически двигател**
- **Asynchronous electric motor.**

Art.No	gross weight	barcode
059908	21.500 kg	3800123123474

CUT OFF MACHINE RD-CM09

- [BG] Циркулар за метал • [RO] Fierastrau circular (metal) • [SR] Testera kružna za metal stacionarna
- [MK] Циркулар за дрво столен • [RU] Торцовочная пила по метал • [SL] Rezalni brusilnik
- [EL] Λειαντήρας κοπής • [HR] Rezna brusilica • [FR] Machine coupée • [IT] Tagliare la macchina
- [ES] Tranču mašīn • [PT] Máquina cortada



230V~ 50Hz	1200 W
5000 min ⁻¹	 180 mm
22.2 mm	7.100 kg
	COLOR BOX



Art.No	gross weight	barcode
060109	18.500 kg	3800972024045

CUT OFF MACHINE RD-CM06

- [BG] Циркулар за метал • [RO] Fierastrau circular (metal) • [SR] Testera kružna za metal stacionarna
- [MK] Циркулар за дрво столен • [RU] Торцовочная пила по метал • [SL] Rezalni brusilnik
- [EL] Λειαντήρας κοπής • [HR] Rezna brusilica • [FR] Machine coupée • [IT] Tagliare la macchina
- [ES] Tranču mašīn • [PT] Máquina cortada



230V~ 50Hz	2000 W
3700 min ⁻¹	 355 mm
25.4 mm	17.800 kg
	COLOR BOX



Art.No	gross weight	barcode
060106	18.500 kg	3800123158650

CUT OFF MACHINE RD-CM08

- [BG] Циркулар за метал • [RO] Fierastrau circular (metal) • [SR] Testera kružna za metal stacionarna
- [MK] Циркулар за дрво столен • [RU] Торцовочная пила по метал • [SL] Rezalni brusilnik
- [EL] Λειαντήρας κοπής • [HR] Rezna brusilica • [FR] Machine coupée • [IT] Tagliare la macchina
- [ES] Tranču mašīn • [PT] Máquina cortada









230V~ 50Hz	2400 W
3700 min ⁻¹	 355 mm
25.4 mm	16.950 kg
	COLOR BOX



Art.No	barcode
060108	3800972016330

METAL-CUTTING BAND SAW SWIVELLING RDP-BSM01

- [BG] Банциг за метал • [RO] Ferestrau pendular de banc • [SR] Trakasta testera
- [MK] Трачна пила • [RU] Ленточная пила • [SL] Tračna žaga
- [EL] Πριονοκορδέλα • [HR] Трачна пила • [FR] Scie à ruban
- [IT] Sega a nastro • [ES] Bando vidis • [PT] Serra de mesa

230V~ 50Hz	1200 W
1500 min ⁻¹	 1400 mm
 max 8 mm	 0-45°
 900 m/min	 200 mm (max)
 80 mm	 max 400 mm
 500 mm 300 mm	16.400 kg



Art.No	gross weight	in cartoon	barcode
060110	18.500 kg	1	3800972027930

SAW BAND FOR STEEL FOR RD-BSW18

- [BG] Лента за банциг за метал • [RO] Ferestrau pendular de banc • [SR] Trakasta testera
- [MK] Трачна пила • [RU] Ленточная пила • [SL] Tračna žaga
- [EL] Πριονοκορδέλα • [HR] Трачна пила • [FR] Scie à ruban
- [IT] Sega a nastro • [ES] Bando vidis • [PT] Serra de mesa



Art.No	gross weight	in cartoon	barcode
155702	18.500 kg	1	3800972027947

BENCH GRINDER RDP-BG02

[BG] Шмиргел • [RO] Polizor de banc • [SR] Stona Brusilica • [MK] Струг • [RU] Станок
Точильный • [SL] Dvojni Brusilnik • [EL] Δίδυμοι τροχοί πάγκου • [HR] Dvostrana stolna brusilica
• [FR] Meuleuse de table • [IT] Smerigliatrice da banco • [ES] Benka muelillo • [PT] Esmeriladora

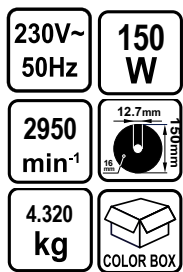

Art.No	gross weight	barcode
061102	4.800 kg	3800123124099

BENCH GRINDER RDP-BG04

[BG] Шмиргел • [RO] Polizor de banc • [SR] Stona Brusilica • [MK] Струг • [RU] Станок
Точильный • [SL] Dvojni Brusilnik • [EL] Δίδυμοι τροχοί πάγκου • [HR] Dvostrana stolna brusilica
• [FR] Meuleuse de table • [IT] Smerigliatrice da banco • [ES] Benka muelillo • [PT] Esmeriladora

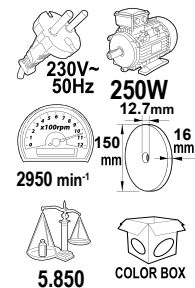

Art.No	gross weight	barcode
061101	6.500 kg	3800123123825

BENCH GRINDER RDP-BG02

[BG] Шмиргел • [RO] Polizor de banc • [SR] Stona Brusilica • [MK] Струг • [RU] Станок
Точильный • [SL] Dvojni Brusilnik • [EL] Δίδυμοι τροχοί πάγκου • [HR] Dvostrana stolna brusilica
• [FR] Meuleuse de table • [IT] Smerigliatrice da banco • [ES] Benka muelillo • [PT] Esmeriladora

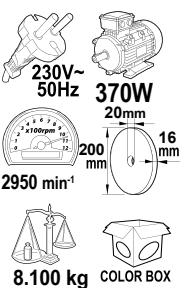

Art.No	gross weight	barcode
061103	9.000 kg	3800123124204

BENCH GRINDER RDP-BG03

[BG] Шмиргел редукторен • [RO] Polizor de banc • [SR] Stona Brusilica • [MK] Струг • [RU]
Станок точильный • [SL] Dvojni brusilnik • [EL] Δίδυμοι τροχοί πάγκου • [HR] Dvostrana stolna
brusilica • [FR] Meuleuse de table • [IT] Smerigliatrice da banco • [ES] Benka muelillo
• [PT] Esmeriladora

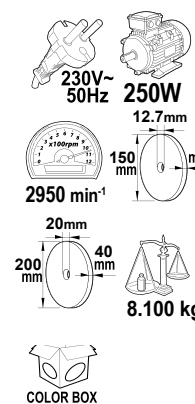

Art.No	gross weight	barcode
061104	9.000 kg	3800123124273

BENCH GRINDER - SANDER RDP-BG05

[BG] Шмиргел с лентов шлайф • [RO] Polizor de banc - Slefuitor • [SR] Stona Brusilica
• [MK] Струг • [RU] Станок Точильный • [SL] Dvojni brusilnik • [EL] Δίδυμοι τροχοί πάγκου
• [HR] Dvostrana stolna brusilica • [FR] Meuleuse d'établi - Ponceuse • [IT] Smerigliatrice da banco
- levigatrice • [ES] Benka Muelillo - sander • [PT] Esmeriladora

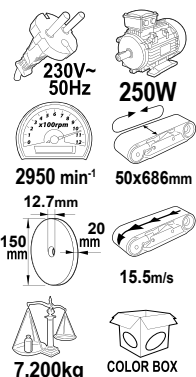

Art.No	gross weight	barcode
061105	8.000 kg	3800123123108

SANDING BELTS FOR BENCH GRINDER WITH SANDING BELT 5 PCS

[BG] Шкурка за лентов шмиргел 5 бр • [RO] Set 5 buc banda smirghel • [SR] Brusna traka Set
5 kom • [MK] Абразивна Трака 5 ком • [RU] Лента для шлифмашины 5 шт. • [SL] Brusni trakovi
kovina 5 kos • [EL] Ιμαντες λειανσης 5 τεμάχια • [HR] Brusna traka za Stolna brusilica 5 kom •
[FR] Papier abrasif pour bande abrasive 5pcs. • [IT] Carta abrasiva per levigatura della cinghia 5
pezzi. • [ES] Papel de lija para lijar cinta 5 pcs. • [PT] Lixa para cinto de lixar 5pcs.

5pcs / 50x686mm



art. №	P	BARCODE
183116	P40	3800123135309
183117	P60	3800123135316
183118	P80	3800123135323
183119	P100	3800123135330
183120	P120	3800123136252

BENCH GRINDER WITH MINI GRINDER RD-BG06

[BG] Шмиргел с мини шлифовалка • [RO] Polizor de banc cu mini polizor drept • [SR] Stona brusilica sa brusilica ђeona • [MK] Струг и брусилка со осило • [RU] Станок точильный с мини шлифмашина [SL] Dvojni brusilnik s mini brusilnik • [EL] Δίδυμοι τροχοί πάγκου мини τροχείο • [HR] Dvostrana stolna brusilica s ravna brusilica • [FR] Meuleuse de table avec mini meuleuse • [IT] Smerigliatrice da banco con mini smerigliatrice • [ES] Benka muelilo kun mini muelillo • [PT] Esmeriladora

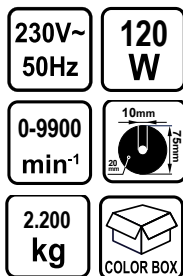

Art.No	gross weight	in cartoon	barcode
129928	2.500 kg	4 pcs	3800123123450

GRINDING WHEEL

[BG] Диск за шмиргел • [RO] Piatra ptr polizor • [SR] Brusni kamen • [MK] Брусни камен бел • [RU] Круг шлифовальный • [SL] Brusilni kamen • [EL] Πέτρα λείανσης (χοντρή) • [HR] Brusna ploča za dvostruke brusilice • [FR] Meule blanche • [IT] Mola bianca • [ES] Muelanta Radon Blanca • [PT] Rebolo branco

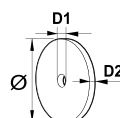

art. №	Ø (mm)	D1 (mm)	D2 (mm)	P	BARCODE
165119	150	13	16	P36	3800123127519
165120	150	13	16	P80	3800123127526
165123	200	16	20	P60	3800123127557
165124	200	20	40	P60	3800123127564

GRINDING WHEEL WHITE

[BG] Диск за шмиргел • [RO] Piatra ptr polizor • [SR] Brusni kamen • [MK] Брусни камен бел • [RU] Круг шлифовальный • [SL] Brusilni kamen • [EL] Πέτρα λείανσης (χοντρή) • [HR] Brusna ploča za dvostruke brusilice • [FR] Meule blanche • [IT] Mola bianca • [ES] Muelanta Radon Blanca • [PT] Rebolo branco

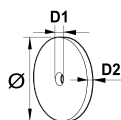

art. №	Ø (mm)	D1 (mm)	D2 (mm)	P	BARCODE
165121	200	16	20	P60	3800123127533

GRINDING WHEEL GREEN

[BG] Диск за шмиргел • [RO] Piatra ptr polizor • [SR] Brusni kamen • [MK] Брусни камен бел • [RU] Круг шлифовальный • [SL] Brusilni kamen • [EL] Πέτρα λείανσης (χοντρή) • [HR] Brusna ploča za dvostruke brusilice • [FR] Meule blanche • [IT] Mola bianca • [ES] Muelanta Radon Blanca • [PT] Rebolo branco

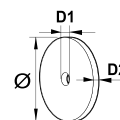

art. №	Ø (mm)	D1 (mm)	D2 (mm)	P	BARCODE
165122	200	16	20	P60	3800123127540

GRINDING WHEEL RED

[BG] Диск за шмиргел • [RO] Piatra ptr polizor • [SR] Brusni kamen • [MK] Брусни камен бел • [RU] Круг шлифовальный • [SL] Brusilni kamen • [EL] Πέτρα λείανσης (χοντρή) • [HR] Brusna ploča za dvostruke brusilice • [FR] Meule blanche • [IT] Mola bianca • [ES] Muelanta Radon Blanca • [PT] Rebolo branco

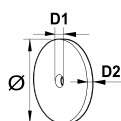

art. №	Ø (mm)	D1 (mm)	D2 (mm)	G	BARCODE
165126	75	10	20	G120	3800123171840

POLISHING WHEEL

[BG] Диск за шмиргел • [RO] Piatra ptr polizor • [SR] Brusni kamen • [MK] Брусни камен бел • [RU] Круг шлифовальный • [SL] Brusilni kamen • [EL] Πέτρα λείανσης (χοντρή) • [HR] Brusna ploča za dvostruke brusilice • [FR] Meule blanche • [IT] Mola bianca • [ES] Muelanta Radon Blanca • [PT] Rebolo branco

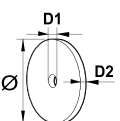

art. №	Ø (mm)	D1 (mm)	D2 (mm)	PVE	BARCODE
165127	75	10	20	400	3800123171857

ELECTRIC SPRAY GUN RD-ESG01

[BG] Пистолет за боя • [RO] Pistol de vopsit • [SR] Pištolj za farbanje električni • [MK] Електричен пистолет за фарбање • [RU] Краскопулт электрический • [SL] Električna razpršilna pištola • [EL] Πιστόλι βαφής ηλεκτρικό • [HR] Pištolj Za prskanje zidne boje • [FR] Pistolet électrique • [IT] Pistola a spruzzo elettrica • [ES] Elektra sprayilo • [PT] Pistola de pintura eléctrica

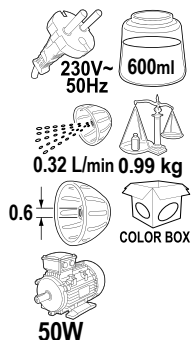

Art.No	gross weight	in cartoon	barcode
129921	2.120 kg	4 pcs	3800123122101

ELECTRIC SPRAY GUN RDP-ESG11P

[BG] Пистолет за боя • [RO] Pistol de vopsit • [SR] Pištolj za farbanje električni • [MK] Електричен пистолет за фарбање • [RU] Краскопулт электрический • [SL] Električna razpršilna pištola • [EL] Πιστόλι βαφής ηλεκτρικό • [HR] Pištolj Za prskanje zidne boje • [FR] Pistolet électrique • [IT] Pistola a spruzzo elettrica • [ES] Elektra sprayilo • [PT] Pistola de pintura eléctrica

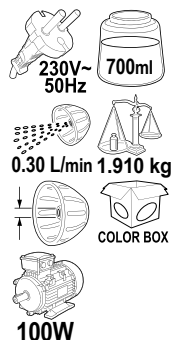

RAIDER[®]
Pro



Art.No	gross weight	in cartoon	barcode
129952	2.120 kg	4 pcs	3800123127861

ELECTRIC SPRAY GUN WITH COMPRESSOR RD-SGC09

[BG] Пистолет за боя с ел. компресор • [RO] Pistol de vopsit cu compresor • [SR] Pištolj za farbanje sa kompresorom • [MK] Пиштол за боја со компресор • [RU] Краскопулт с электрическим компрессором • [SL] lakirna pištola • [EL] Πιστόλι βαφής ηλεκτρικό Κομπρεσσер • [HR] Sustav Za Prskanje Boje • [FR] Pistolet de pulvérisation avec compresseur électrique • [IT] Pistola a spruzzo con compressore elettrico • [ES] Špruca pafilo per elektra kompresoro • [PT] Pistola de pintura com compressor elétrico



Art.No	gross weight	in cartoon	barcode
074107	1.790 kg		3800972015166

ELECTRIC SPRAY GUN WITH COMPRESSOR RD-SGC06

[BG] Пистолет за боя с ел. компресор • [RO] Pistol de vopsit cu compresor • [SR] Pištolj za farbanje sa kompresorom • [MK] Пиштол за боја со компресор • [RU] Краскопулт с электрическим компрессором • [SL] lakirna pištola • [EL] Πιστόλι βαφής ηλεκτρικό Κομπρεσσер • [HR] Sustav Za Prskanje Boje • [FR] Pistolet de pulvérisation avec compresseur électrique • [IT] Pistola a spruzzo con compressore elettrico • [ES] Špruca pafilo per elektra kompresoro • [PT] Pistola de pintura com compressor elétrico

Strap for comfortable and easy carrying



Art.No	gross weight	in cartoon	barcode
074105	3.220 kg	4 pcs	3800123167850

ELECTRIC SPRAY GUN WITH COMPRESSOR RDP-SGC08

[BG] Пистолет за боя с ел. компресор • [RO] Pistol de vopsit cu compresor • [SR] Pištolj za farbanje sa kompresorom • [MK] Пиштол за боја со компресор • [RU] Краскопулт с электрическим компрессором • [SL] lakirna pištola • [EL] Πιστόλι βαφής ηλεκτρικό Κομπρεσσер • [HR] Sustav Za Prskanje Boje • [FR] Pistolet de pulvérisation avec compresseur électrique • [IT] Pistola a spruzzo con compressore elettrico • [ES] Špruca pafilo per elektra kompresoro • [PT] Pistola de pintura com compressor elétrico



Art.No	gross weight	in cartoon	barcode
074201	4.080 kg	6 pcs	3800123162206

HEAT GUN RD-HG17

[BG] Пистолет за горещ въздух • [RO] Pistol cu aer cald • [SR] Pištolj za vrelí vazduh • [MK] Фен • [RU] Пистолет горячего воздуха • [SL] Vroca zrasna pištola • [EL] Πιστόλι φερμου αέρα • [HR] Pištolj za vrući zrak • [FR] Arbre à air chaud • [IT] Pistola aria calda • [ES] Pistola de aire caliente • [PT] Soprador de ar quente

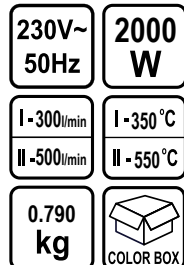

Art.No	gross weight	in cartoon	barcode
074306	0.880 kg	10 pcs	3800972001862

HEAT GUN RD-HG14

[BG] Пистолет за горещ въздух • [RO] Pistol cu aer cald • [SR] Pištolj za vreli vazduh • [MK] Фен
 • [RU] Пистолет горячего воздуха • [SL] Vroca zracna pištola • [EL] Πιστολι φερμου αερα
 • [HR] Pištolj za vrući zrak • [FR] Arbre à air chaud • [IT] Pistola aria calda • [ES] Pistola de aire caliente • [PT] Soprador de ar quente

230V~ 50Hz	2000 W
I - 250 l/min	I - 250 °C
II - 550 l/min	II - 550 °C
5 pcs ↑ ↑ ↑	0.9 kg
 COLOR BOX	



Art.No	gross weight	in cartoon	barcode
074302	1.000 kg	10 pcs	3800123162916

HEAT GUN RD-HG18

[BG] Пистолет за горещ въздух • [RO] Pistol cu aer cald • [SR] Pištolj za vreli vazduh • [MK] Фен
 • [RU] Пистолет горячего воздуха • [SL] Vroca zracna pištola • [EL] Πιστολι φερμου αερα
 • [HR] Pištolj za vrući zrak • [FR] Arbre à air chaud • [IT] Pistola aria calda • [ES] Pistola de aire caliente • [PT] Soprador de ar quente

230V~ 50Hz	2000 W
I - 240 l/min	I - 80-300 °C
II - 480 l/min	II - 80-600 °C
1.580 kg	



Art.No	gross weight	in cartoon	barcode
074307	1.760 kg	5 pcs	3800972001954

HEAT GUN RD-HG22

[BG] Пистолет за горещ въздух • [RO] Pistol cu aer cald • [SR] Pištolj za vreli vazduh • [MK] Фен
 • [RU] Пистолет горячего воздуха • [SL] Vroca zracna pištola • [EL] Πιστολι φερμου αερα
 • [HR] Pištolj za vrući zrak • [FR] Arbre à air chaud • [IT] Pistola aria calda • [ES] Pistola de aire caliente • [PT] Soprador de ar quente

230V~ 50Hz	2000 W
I - 300 l/min	I - 350 °C
II - 500 l/min	II - 550 °C
0.800 kg	



Art.No	gross weight	in cartoon	barcode
074311	1.660 kg	10 pcs	3800972002500

HEAT GUN RD-HG12

[BG] Пистолет за горещ въздух • [RO] Pistol cu aer cald • [SR] Pištolj za vreli vazduh • [MK] Фен
 • [RU] Пистолет горячего воздуха • [SL] Vroca zracna pištola • [EL] Πιστολι φερμου αερα
 • [HR] Pištolj za vrući zrak • [FR] Arbre à air chaud • [IT] Pistola aria calda • [ES] Pistola de aire caliente • [PT] Soprador de ar quente

230V~ 50Hz	2000 W
I - 240 l/min	I - 80-300 °C
II - 480 l/min	II - 80-600 °C
0.790 kg	



Art.No	gross weight	in cartoon	barcode
122105	2.000 kg	5 pcs	3800123143885

HEAT GUN RDP-HG21

[BG] Пистолет за горещ въздух • [RO] Pistol cu aer cald • [SR] Pištolj za vreli vazduh • [MK] Фен
 • [RU] Пистолет горячего воздуха • [SL] Vroca zracna pištola • [EL] Πιστολι φερμου αερα
 • [HR] Pištolj za vrući zrak • [FR] Arbre à air chaud • [IT] Pistola aria calda • [ES] Pistola de aire caliente • [PT] Soprador de ar quente

 230V~ 50Hz 2000W
I - 350 l/min
II - 350 l/min
III - 500 l/min
I - 60 °C
II - 60 - 350 °C
III - 350 - 550 °C

5 pcs ↑ ↑ ↑	LCD DISPLAY
----------------	----------------

 1.22 kg	 COLOR BOX
--	--

**RAIDER®
Pro**

Art.No	gross weight	in cartoon	barcode
074310	1.360 kg	10 pcs	3800972002494

HEAT GUN RD-HG23

[BG] Пистолет за горещ въздух • [RO] Pistol cu aer cald • [SR] Pištolj za vreli vazduh • [MK] Фен
 • [RU] Пистолет горячего воздуха • [SL] Vroca zracna pištola • [EL] Πιστολι φερμου αερα
 • [HR] Pištolj za vrući zrak • [FR] Arbre à air chaud • [IT] Pistola aria calda • [ES] Pistola de aire caliente • [PT] Soprador de ar quente

230V~ 50Hz	2000 W
I - 300 l/min	I - 50 °C
II - 300 l/min	II - 70 - 600 °C
III - 500 l/min	III - 70 - 600 °C
LCD DISPLAY	5 pcs ↑ ↑ ↑
1.490 kg	



Art.No	gross weight	in cartoon	barcode
074312	1.660 kg	10 pcs	3800972002517

ELECTRIC WEED BURNER RD-HG20

[BG] Пистолет за горещ въздух • [RO] Arzator electric de bucurieni • [SR] Pištolj za vreli vazduh • [MK] Фен • [RU] Пистолет горячего воздуха • [SL] Vroca zrasna pištola • [EL] Πιστολι φερμου αερα • [HR] Pištolj za vrući zrak • [FR] Arbre à air chaud • [IT] Pistola aria calda • [ES] Pistola de aire caliente • [PT] Ar quente

230V~
50Hz

2000
W

650°C

1.400
kg

COLOR BOX



Art.No	gross weight	in cartoon	barcode
074309	1.690 kg	8 pcs	3800972001978

HANDLE MIXER RD-HM05

[BG] Миксер • [RO] Amestecator • [SR] Mešač • [MK] Рачна Мешалка • [RU] Перемешиватель • [SL] Mešalnik • [EL] Δραπάνο Αναδευτήρας • [HR] Miješalica • [FR] Mélangeur à poignée • [IT] Maneggiare il mixer • [ES] Manlibro miksažo • [PT] Misturadora manual

230V~
50Hz

850
W

0-550
min⁻¹

10 mm

16 mm

13 mm

3.900
kg

COLOR BOX



Art.No	gross weight	in cartoon	barcode
078503	4.540 kg	4 pcs	3800123133732

HANDLE MIXER RD-HM07

[BG] Миксер • [RO] Amestecator • [SR] Mešač • [MK] Рачна Мешалка • [RU] Перемешиватель • [SL] Mešalnik • [EL] Δραπάνο Αναδευτήρας • [HR] Miješalica • [FR] Mélangeur à poignée • [IT] Maneggiare il mixer • [ES] Manlibro miksažo • [PT] Misturadora manual

230V~
50Hz

1200
W

0-600
min⁻¹

M14x2mm

Ø120/590
mm

max
40L

3.900
kg

COLOR BOX



Art.No	gross weight	in cartoon	barcode
078508	4.400 kg	4 pcs	3800972009219

HANDLE MIXER RD-HM05

[BG] Миксер • [RO] Amestecator • [SR] Mešač • [MK] Рачна Мешалка • [RU] Перемешиватель • [SL] Mešalnik • [EL] Δραπάνο Αναδευτήρας • [HR] Miješalica • [FR] Mélangeur à poignée • [IT] Maneggiare il mixer • [ES] Manlibro miksažo • [PT] Misturadora manual

230V~
50Hz

1600
W

0-750
min⁻¹

10 mm

16 mm

13 mm

4.88
kg

COLOR BOX



Art.No	gross weight	in cartoon	barcode
078511	4.88 kg	4 pcs	3800972019720

HANDLE MIXER RD-HM08

[BG] Миксер • [RO] Amestecator • [SR] Mešač • [MK] Рачна Мешалка • [RU] Перемешиватель • [SL] Mešalnik • [EL] Δραπάνο Αναδευτήρας • [HR] Miješalica • [FR] Mélangeur à poignée • [IT] Maneggiare il mixer • [ES] Manlibro miksažo • [PT] Misturadora manual

230V~
50Hz

1400
W

M14x2mm

Ø120/590
mm

LED

5.030
kg

200-700
min⁻¹

max
40L

COLOR BOX



Art.No	gross weight	in cartoon	barcode
078509	6.000 kg	4 pcs	3800972009158

HANDLE MIXER RDP-HM10

[BG] Миксер • [RO] Amestecator • [SR] Mešač • [MK] Рачна Мешалка • [RU] Перемешиватель • [SL] Mešalnik • [EL] Δραπάνο Αναδευτήρας • [HR] Miješalica • [FR] Mélangeur à poignée • [IT] Maneggiare il mixer • [ES] Manlibro miksažo • [PT] Misturadora manual

230V~
50Hz

2 x
GEARS

1600W

VARIABLE SPEED

1' 100 - 450 min⁻¹
2' 150 - 750 min⁻¹

5.9 kg

Ø120/140
mm

COLOR BOX



Art.No	gross weight	barcode
078602	6.900 kg	380097208020

RAIDER
PRO

HANDLE MIXER WITH TWO PADDLES RDP-HM09

[BG] Миксер с две бържалки • [RO] Amestecator cu două palete • [SR] Mešač sa dve lopatice
 • [MK] Рачна Мешалка со две лостови • [RU] Перемешиватель с двумя лопастями
 • [SL] Mešalnik z dvema ročicama • [EL] Δραπάνο Αναδευτήρας • [HR] Miješalica s dvije lopatice
 • [FR] Mélangeur à deux palettes • [IT] Maneggiare il mixer con due paddle • [ES] Uzu miksajon kun du pakajoj • [PT] Misturadora manual com duas pás

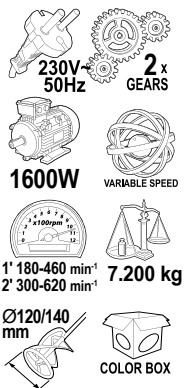
RAIDER®
 Pro

Art.No	gross weight	in cartoon	barcode
078601	8.900 kg	2 pcs	3800972010758

TILE CUTTING MACHINE RD-TC02

[BG] Машина за плочки • [RO] Dispozitiv pt taiat placi • [SR] Mašina za sečenje pločica
 • [MK] Машина за сечење на плочки [RU] Машина для резки плитки • [SL] Rezalnik za keramične ploščice • [EL] Κόφτης πλακιδίων χειρός • [HR] Rezač ručni za keramičke pločice
 • [FR] Machine à couper les carreaux • [IT] Tagliapiastrelle • [ES] Kahela mašino • [PT] Máquina de corte de cerâmica



Art.No	gross weight	in cartoon	barcode
321501	1.700 kg	6 pcs	3800123116308

TILE CUTTING MACHINE RD-TC03

[BG] Машина за плочки • [RO] Dispozitiv pt taiat placi • [SR] Mašina za sečenje pločica
 • [MK] Машина за сечење на плочки [RU] Машина для резки плитки • [SL] Rezalnik za keramične ploščice • [EL] Κόφτης πλακιδίων χειρός • [HR] Rezač ručni za keramičke pločice
 • [FR] Machine à couper les carreaux • [IT] Tagliapiastrelle • [ES] Kahela mašino • [PT] Máquina de corte de cerâmica



Art.No	gross weight	in cartoon	barcode
321511	3.980 kg	6 pcs	3800123116483

TILE CUTTING MACHINE

[BG] Машина за плочки • [RO] Dispozitiv pt taiat placi • [SR] Mašina za sečenje pločica
 • [MK] Машина за сечење на плочки [RU] Машина для резки плитки • [SL] Rezalnik za keramične ploščice • [EL] Κόφτης πλακιδίων χειρός • [HR] Rezač ručni za keramičke pločice
 • [FR] Machine à couper les carreaux • [IT] Tagliapiastrelle • [ES] Kahela mašino • [PT] Máquina de corte de cerâmica



Art.No	Size	Weight	gross weight	in cartoon	barcode
321502 RD-TC10	400	4.800	4.820 kg	4 pcs	3800123116322
321507 RD-TC12	500	5.240	5.270 kg	4 pcs	3800123116315
321503 RD-TC13	600	5.700	5.880 kg	4 pcs	3800123116339

TILE CUTTING MACHINE RD-TC11

[BG] Машина за плочки • [RO] Dispozitiv pt taiat placi • [SR] Mašina za sečenje pločica
 • [MK] Машина за сечење на плочки [RU] Машина для резки плитки • [SL] Rezalnik za keramične ploščice • [EL] Κόφτης πλακιδίων χειρός • [HR] Rezač ručni za keramičke pločice
 • [FR] Machine à couper les carreaux • [IT] Tagliapiastrelle • [ES] Kahela mašino • [PT] Máquina de corte de cerâmica



Art.No	gross weight	in cartoon	barcode
321510	7.750 kg	4 pcs	3800123116292

TILE CUTTING MACHINE RD-TC14

[BG] Машина за плочки • [RO] Dispozitiv pt taiat placi • [SR] Mašina za sečenje pločica
 • [MK] Машина за сечење на плочки [RU] Машина для резки плитки • [SL] Rezalnik za keramične ploščice • [EL] Κόφτης πλακιδίων χειρός • [HR] Rezač ručni za keramičke pločice
 • [FR] Machine à couper les carreaux • [IT] Tagliapiastrelle • [ES] Kahela mašino • [PT] Máquina de corte de cerâmica



Art.No	gross weight	in cartoon	barcode
321514	7.350 kg	2 pcs	3800123150425

TILE CUTTING MACHINE RD-TC16

[BG] Машина за плочки • [RO] Dispozitiv pt taiat placi • [SR] Mašina za sečenje pločica
• [MK] Машина за сечење на плочки [RU] Машина для резки плитки • [SL] Rezalnik za keramične ploščice • [EL] Κόφτης πλακιδίων χειρός • [HR] Rezač ručni za keramičke pločice
• [FR] Machine à couper les carreaux • [IT] Tagliapiastrelle • [ES] Kahela mašino • [PT] Máquina de corte de cerâmica



8.480
kg



Art.No	gross weight	in cartoon	barcode
321509	8.500 kg		3800123116452

TILE CUTTING MACHINE RD-TC31

[BG] Машина за плочки • [RO] Dispozitiv pt taiat placi • [SR] Mašina za sečenje pločica
• [MK] Машина за сечење на плочки [RU] Машина для резки плитки • [SL] Rezalnik za keramične ploščice • [EL] Κόφτης πλακιδίων χειρός • [HR] Rezač ručni za keramičke pločice
• [FR] Machine à couper les carreaux • [IT] Tagliapiastrelle • [ES] Kahela mašino • [PT] Máquina de corte de cerâmica



8.900
kg



Art.No	gross weight	in cartoon	barcode
321522	9.000 kg	2 pcs	3800972008953

TILE CUTTING MACHINE RD-TC18

[BG] Машина за плочки • [RO] Dispozitiv pt taiat placi • [SR] Mašina za sečenje pločica
• [MK] Машина за сечење на плочки [RU] Машина для резки плитки • [SL] Rezalnik za keramične ploščice • [EL] Κόφτης πλακιδίων χειρός • [HR] Rezač ručni za keramičke pločice
• [FR] Machine à couper les carreaux • [IT] Tagliapiastrelle • [ES] Kahela mašino • [PT] Máquina de corte de cerâmica



9.550
kg



Art.No	gross weight	in cartoon	barcode
321515	10.230 kg	2 pcs	3800123150418

TILE CUTTING MACHINE RDP-TC32

[BG] Машина за плочки • [RO] Dispozitiv pt taiat placi • [SR] Mašina za sečenje pločica
• [MK] Машина за сечење на плочки [RU] Машина для резки плитки • [SL] Rezalnik za keramične ploščice • [EL] Κόφτης πλακιδίων χειρός • [HR] Rezač ručni za keramičke pločice
• [FR] Machine à couper les carreaux • [IT] Tagliapiastrelle • [ES] Kahela mašino • [PT] Máquina de corte de cerâmica



12.00
kg



RAIDER[®]
Pro

Art.No	gross weight	in cartoon	barcode
321523	12.00 kg	1 pcs	3800972024359

SAFETY KNEEPADS RAIDER

[BG] Наколенки • [RO] Genunchiere • [SR] Jastučici za kolena • [MK] Влошки за колена
• [RU] Наколенники [SL] Ščitniki za kolena • [EL] Επιγονατίδες • [HR] Štitnici za koljena
• [FR] Genouillères • [IT] Ginocchiere • [ES] Rodilleras • [PT] Joelheiras



Art.No	gross weight	in cartoon	barcode
560501	---	---	3800972025547

TILE CUTTER BLADE

[BG] Резец За машина за плочки • [RO] Cap taiere placi • [SR] Nož za mašinu zasečenje pločica
• [MK] Сечило за машина за сечење на плочки • [RU] Резак машина для резки плитки • [SL] Rezalnik za keramične ploščice • [EL] Κοπή για Κόφτης Πλακιδίων Χειρός • [HR] Nož za ručna pila, precizna za kut • [FR] Lame de coupe de tuile • [IT] Tagliapiastrelle • [ES] Tondilo de Kahelo • [PT] Lámina de corte de telha



art. №	W (mm)	BARCODE
321504 for RD-TC10,12,13	15x6x2	3800123116353
321520 for RD-TC11,14,18	22x10.5x2	3800123153938



art. №	W (mm)	BARCODE
321518 for RD-TC01,02,03	15x6x1.5	3800123150456
321521 for RD-TC16	16x4x3	3800123104749

TILE CUTTING MACHINE RD-ETC25

[BG] Машина за плочки • [RO] Dispozitiv pt taiat placi • [SR] Mašina za sečenje pločica
 • [MK] Машина за сечење на плочки [RU] Машина для резки плитки • [SL] Rezalnik za keramične ploščice • [EL] Κόφτης πλακιδίων χειρός • [HR] Rezač ručni za keramičke pločice
 • [FR] Machine à couper les carreaux • [IT] Tagliapiastrelle • [ES] Kahela mašino • [PT] Máquina de corte de cerâmica

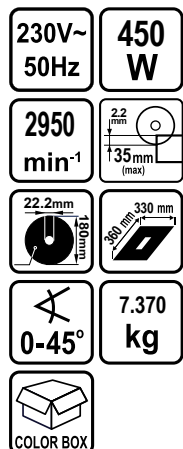

Art.No	gross weight	in cartoon	barcode
129991	10.500 kg		3800123131486

TILE CUTTING MACHINE RD-ETC20

[BG] Машина за плочки • [RO] Dispozitiv pt taiat placi • [SR] Mašina za sečenje pločica
 • [MK] Машина за сечење на плочки [RU] Машина для резки плитки • [SL] Rezalnik za keramične ploščice • [EL] Κόφτης πλακιδίων χειρός • [HR] Rezač ručni za keramičke pločice
 • [FR] Machine à couper les carreaux • [IT] Tagliapiastrelle • [ES] Kahela mašino • [PT] Máquina de corte de cerâmica

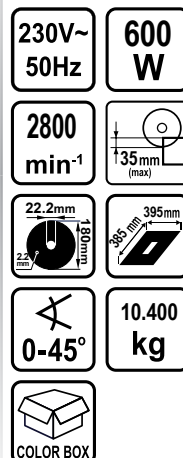

Art.No	gross weight	barcode
129908	11.500 kg	3800123124495

TILE CUTTING MACHINE RD-ETC23

[BG] Машина за плочки • [RO] Dispozitiv pt taiat placi • [SR] Mašina za sečenje pločica
 • [MK] Машина за сечење на плочки [RU] Машина для резки плитки • [SL] Rezalnik za keramične ploščice • [EL] Κόφτης πλακιδίων χειρός • [HR] Rezač ručni za keramičke pločice
 • [FR] Machine à couper les carreaux • [IT] Tagliapiastrelle • [ES] Kahela mašino • [PT] Máquina de corte de cerâmica

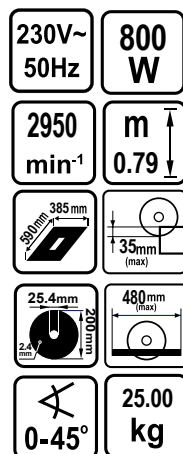

Art.No	gross weight	in cartoon	barcode
129937	27.000 kg	1 pcs	3800123123061

TILE CUTTING MACHINE RDP-ETC27

[BG] Машина за плочки • [RO] Dispozitiv pt taiat placi • [SR] Mašina za sečenje pločica
 • [MK] Машина за сечење на плочки [RU] Машина для резки плитки • [SL] Rezalnik za keramične ploščice • [EL] Κόφτης πλακιδίων χειρός • [HR] Rezač ručni za keramičke pločice
 • [FR] Machine à couper les carreaux • [IT] Tagliapiastrelle • [ES] Kahela mašino • [PT] Máquina de corte de cerâmica

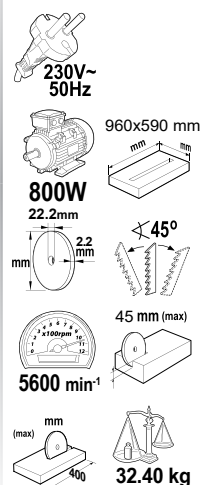

Art.No	gross weight	barcode
078002	36.000 kg	3800123159060

TILE CUTTING MACHINE RDP-ETC30

[BG] Машина за плочки • [RO] Dispozitiv pt taiat placi • [SR] Mašina za sečenje pločica
 • [MK] Машина за сечење на плочки [RU] Машина для резки плитки • [SL] Rezalnik za keramične ploščice • [EL] Κόφτης πλακιδίων χειρός • [HR] Rezač ručni za keramičke pločice
 • [FR] Machine à couper les carreaux • [IT] Tagliapiastrelle • [ES] Kahela mašino • [PT] Máquina de corte de cerâmica

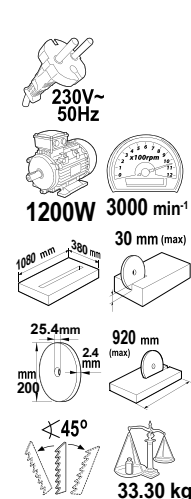

Art.No	gross weight	barcode
078005	37.000 kg	3800123172199

TILE CUTTING MACHINE RDP-ETC31

[BG] Машина за плочки • [RO] Dispozitiv pt taiat placi • [SR] Mašina za sečenje pločica
 • [MK] Машина за сечење на плочки [RU] Машина для резки плитки • [SL] Rezalnik za keramične ploščice • [EL] Κόφτης πλακιδίων χειρός • [HR] Rezač ručni za keramičke pločice
 • [FR] Machine à couper les carreaux • [IT] Tagliapiastrelle • [ES] Kahela mašino • [PT] Máquina de corte de cerâmica

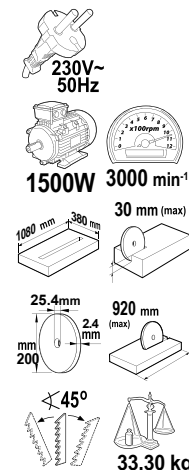

Art.No	gross weight	barcode
078006	---	3800972025219

BLOW TORCH

[BG] Горелка със спусък • [RO] Arzator • [SR] Gasni brener • [MK] Горилник со активирање
• [RU] Газовая горелка • [SL] Plinski gorilnik • [EL] Καμινέτο υγραερίου • [HR] Plamenik Sa
Ručkom • [FR] Brûleur • [IT] Bruciatore • [ES] Burner • [PT] Queimador

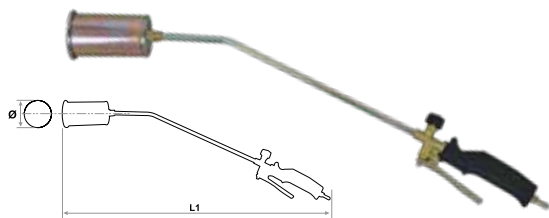

art. №	Ø (mm)	L1 (mm)	BARCODE
491512 for RD-GHT01	40	30	3800123118722
491513 for RD-GHT02	50	40	3800123118739
491514 for RD-GHT03	60	40	3800123118746

BLOW TORCH FOR CARTRIDGE PIEZO

[BG] Горелка за патрон с пиезо • [RO] Lampă de gaz cu arzător • [SR] Gasni brener
• [MK] Горилник со тенк • [RU] Газовая горелка • [SL] Plinski gorilnik • [EL] Καμινέτο υγραερίου
• [HR] Plamenik Plinski • [FR] Brûleur à gaz • [IT] Bruciatore a gas • [ES] Gasfumilo • [PT] Queimador
a gás



Art.No	barcode
450101	3800123164606

PPR PIPE WELDING SET RD-PW01

[BG] Поялник за PP тръби 3 глави • [RO] Dispozitiv pentru lipit tevi PPR set • [SR] Pegla za
plastične sevi • [MK] Греалка за пластични цевки • [RU] Паяльник для сварки пропиленовых
труб • [SL] Spajkalnik polipropilena • [EL] Μηχάνημα συγκόλλησης πλαστικών • [HR] Aparat za
varenje PPR cijevi • [FR] Fer à souder pour le soudage de tubes en propylène • [IT] Saldatore per
saldatura di tubi in propilene • [ES] Solda fero por veldi pipojn de propileno • [PT] Kit soldadora
de PPR

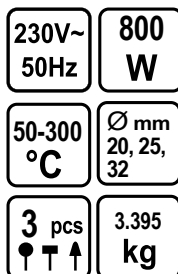

Art.No	gross weight	in cartoon	barcode
123103	4.170 kg	6 pcs	3800123123023

PPR PIPE WELDING SET RD-PW02

[BG] Поялник за PP тръби 3 глави • [RO] Dispozitiv pentru lipit tevi PPR set • [SR] Pegla za
plastične sevi • [MK] Греалка за пластични цевки • [RU] Паяльник для сварки пропиленовых
труб • [SL] Spajkalnik polipropilena • [EL] Μηχάνημα συγκόλλησης πλαστικών • [HR] Aparat za
varenje PPR cijevi • [FR] Fer à souder pour le soudage de tubes en propylène • [IT] Saldatore per
saldatura di tubi in propilene • [ES] Solda fero por veldi pipojn de propileno • [PT] Kit soldadora
de PPR

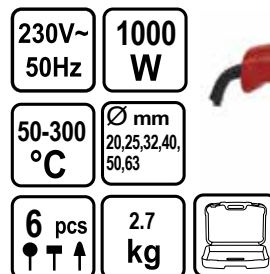

Art.No	gross weight	in cartoon	barcode
123104	3.000 kg	6 pcs	3800123123054

SOCKET FOR PP PIPE WELDING

[BG] Глава за поялник за PP тръби • [RO] Matrita pt lipit tevi PPR • [SR] Nastavak za peglu za
plastične sevi • [MK] Продолжение на Електричен заварувач за пластични цевки • [RU] Насадка
для полипропиленовых труб • [SL] Nastavka za Varilnik za PP-R sevi • [EL] Καλούπια για
Μηχάνημα συγκόλλησης πλαστικών • [HR] Nastavak za varenje PPR-a • [FR] Douille pour soudage
de tubes en PP • [IT] Presa per saldatura tubi in PP • [ES] Socket por PP-tubo-soldado •
[PT] Soquete para soldagem de tubos PP



art. №	Ø (mm)	BARCODE
123108	20	3800123151156
123109	25	3800123151163
123110	32	3800123151170
123111	40	3800123151187



SOLDERING IRON SHARP TIP

[BG] Поялник с остър връх • [RO] Letcon • [SR] Lemilica • [MK] Пиштол за лемење [RU]
Универсальный паяльник • [SL] Spajkalnik • [EL] Κολλητήρι • [HR] Lemilica Tanki Vrh • [FR] Fer à
souder universel • [IT] Saldatore universale • [ES] Universala solderilo • [PT] Soldador

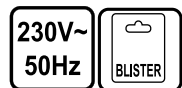

art. №	W	weight kg	BARCODE
123107 RD-S101J	40	0.255	3800123143854
076401 RD-S102J	60	0.255	3800123159145
076402 RD-S103J	80	0.290	3800123159152

SOLDERING IRON, TIN ABSORPTION PUMP, TIN KIT

[BG] Поялник, Помпа за калай, Тинол паста к-т • [RO] Set lipire Letcon, Pompa, Fluidor • [SR] Lemilica, Apsorcija pumpe, Pasta za lemljenje • [MK] Пиштол за лемене, Пумпа за калај, Паста за лемене к-т • [RU] Паяльник, Насос олова, Паяльная паста Набор • [SL] Sprajkalnik, črpalka za kositer, Pasta za sprajkanje Set • [EL] Κολλητήρι, Αποκόλλησης της αντλίας, πάστα συγκόλλησης • [HR] Lemilica, Pumpicu Za Odlemljivanje, pasta za lemljenje k-t • [FR] Fer à souder, pompe d'absorption d'étain, kit d'étain • [IT] Saldatore, pompa di assorbimento dello stagno, kit di stagno • [ES] Soldanta Fero, Stana Absorbado-Bombo, Stana Ilaro • [PT] Ferro de solda, Bomba de absorção de estanho, Kit de estanho

230V~
50Hz

40
W

0.255
kg



Art.No	gross weight	in cartoon	barcode
076406	0.400 kg	30 pcs	3800123166952

SOLDERING IRON FLAT TIP RD-S104J

[BG] Поялник плосък връх прав • [RO] Letcor • [SR] Lemilica • [MK] Пиштол за лемене • [RU] Универсальный паяльник • [SL] Sprajkalnik • [EL] Κολλητήρ • [HR] Lemilica Tanki Vrh • [FR] Fer à souder universel • [IT] Saldatore universale • [ES] Universala solderilo • [PT] Soldador

230V~
50Hz

60
W

0.230
kg



Art.No	gross weight	in cartoon	barcode
076403	0.260 kg	50 pcs	3800123159169

SOLDERING IRON FLAT BENT TIP RD-S105J

[BG] Поялник плосък връх извит • [RO] Letcon • [SR] Lemilica • [MK] Пиштол за лемене • [RU] Универсальный паяльник • [SL] Sprajkalnik • [EL] Κολλητήρι • [HR] Lemilica Tanki Vrh • [FR] Fer à souder universel • [IT] Saldatore universale • [ES] Universala solderilo • [PT] Soldador

230V~
50Hz

0.270
kg



Art.No	gross weight	W	in cartoon	barcode
076404	0.270 kg	60	50 pcs	3800123159176
076409	0.270 kg	100	50 pc	3800972018907

SOLDERING IRON STATION RD-S101

[BG] Станция за запояване • [RO] Statie de lipit • [SR] Stanica za lemljenje • [MK] Лемна станица • [RU] Паяльная станция • [SL] Sprajkalne postaje • [EL] Συγκόλληση σταθμός • [HR] Stanica za lemljenje • [FR] Station de soudure • [IT] Stazione di saldatura • [ES] Soldanta stacio • [PT] Estação de soldar

230V~
50Hz

40
W

600
°C



0.800
kg



Art.No	gross weight	in cartoon	barcode
076408	0.660 kg	20 pcs	3800123166976

SOLDERING GUN

[BG] Поялник индукционен • [RO] Pistol pentru lipit • [SR] Lemilica • [MK] Пиштол за лемене • [RU] Универсальный паяльник • [SL] Sprajkalnik • [EL] Κολλητήρι • [HR] Lemilica pištolj • [FR] Fer à souder universel • [IT] Pistola per saldatura • [ES] Soldanta pafilo • [PT] Pistola de soldar

230V~
50Hz



art. №	W	weight kg	°C	BARCODE
076407 RD-SOG03	100	0.600	600	3800123166969
123105 RD-SOG02	175	0.720	600	3800123123818

TIN ABSORPTION PUMP

[BG] Помпа за калай • [RO] Pompa absorbtie fluidor • [SR] Apsorcija pumpe • [MK] Пумпа за калај • [RU] Насос олова • [SL] Črpalka za kositer • [EL] Αποκόλλησης της αντλίας • [HR] Pumpicu za odlemljivanje • [FR] pompe d'absorption d'étain • [IT] Pompa di assorbimento di stagno • [ES] Stano absorción pumpilo • [PT] Bomba de absorção de estanho

0.055
kg



Art.No	gross weight	in cartoon	barcode
076405	0.070 kg	100 pcs	3800123159183

SOLDER WIRE

[BG] Тинол • [RO] Fludor • [SR] Žica za lemljenje • [MK] Жица за лемење • [RU] Проволочного припоя • [SL] Spajkalna žica • [EL] Κόλληση • [HR] Tinol zica za lemljenje • [FR] Fil de soudure • [IT] Filo di saldatura • [ES] Drato de soldo • [PT] Fio de solda

60%Sn 40%Pb

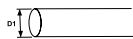

art. №	D1 (mm)	weight (g)	BARCODE
209924	1	200	3800123153518
209925	1.6	200	3800123153525
156601	1	200	3800972024212
156602	1.6	200	3800972024229

HOT MELT GLUE GUN RD-GLG03

[BG] Поялник за силикон • [RO] Pistol pentru lipit cu silicon • [SR] Pištolj za lepljenje • [MK] Пиштол за топло лепење • [RU] Пистолет клеевой электрический • [SL] Pištola za lepljenje • [EL] Κόλλη όπλο • [HR] Silikonski pištolj • [FR] Pistolet à colle électrique • [IT] Pistola per colla elettrica • [ES] Elektra glumpafilo • [PT] Aplicador de cola quente



DUSE DIAMETER
Ø 1.3 mm



GLUE STICKS
Ø 7 mm

Art.No	gross weight	in cartoon	barcode
076201	0.240 kg	48 pcs	3800123162077

HOT MELT GLUE GUN RD-GLG06

[BG] Поялник за силикон • [RO] Pistol pentru lipit cu silicon • [SR] Pištolj za lepljenje • [MK] Пиштол за топло лепење • [RU] Пистолет клеевой электрический • [SL] Pištola za lepljenje • [EL] Κόλλη όπλο • [HR] Silikonski pištolj • [FR] Pistolet à colle électrique • [IT] Pistola per colla elettrica • [ES] Elektra glumpafilo • [PT] Aplicador de cola quente



GLUE STICKS
Ø 7 mm

Art.No	gross weight	barcode
076204	0.240 kg	3800972012721

HOT MELT GLUE GUN RD-GLG04

[BG] Поялник за силикон • [RO] Pistol pentru lipit cu silicon • [SR] Pištolj za lepljenje • [MK] Пиштол за топло лепење • [RU] Пистолет клеевой электрический • [SL] Pištola za lepljenje • [EL] Κόλλη όπλο • [HR] Silikonski pištolj • [FR] Pistolet à colle électrique • [IT] Pistola per colla elettrica • [ES] Elektra glumpafilo • [PT] Aplicador de cola quente



DUSE DIAMETER
Ø 1.8 mm



GLUE STICKS
Ø 11 mm

Art.No	gross weight	in cartoon	barcode
076202	0.380 kg	24 pcs	3800123162084

HOT MELT GLUE GUN RD-GLG07

[BG] Поялник за силикон • [RO] Pistol pentru lipit cu silicon • [SR] Pištolj za lepljenje • [MK] Пиштол за топло лепење • [RU] Пистолет клеевой электрический • [SL] Pištola za lepljenje • [EL] Κόλλη όπλο • [HR] Silikonski pištolj • [FR] Pistolet à colle électrique • [IT] Pistola per colla elettrica • [ES] Elektra glumpafilo • [PT] Aplicador de cola quente

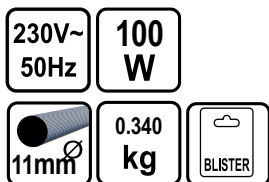

GLUE STICKS
Ø 11 mm

Art.No	gross weight	in cartoon	barcode
076205	0.360 kg		3800972012738

GLUE STICKS FOR GLUE GUNS

[BG] Силиконови пръчки прозрачни • [RO] Batoane silicon transparent • [SR] Topivi lepak Transparentni • [MK] Стапче за лепење • [RU] Набор стержней для клей-пистолета прозрачный • [SL] Lepilne palice, prozorne • [EL] Ράβδοι κόλλας διαφανής • [HR] Silikonski štapići • [FR] Bâtons de silicone transparents • [IT] Bastoncini di silicone trasparente • [ES] Silikaj bastonaj travedeblaj • [PT] Varas de silicone transparentes

GLUE STICKS FOR GLUE GUNS TRANSPARENT



art. №	D1 (mm)	L1 (mm)	weight (g)	BARCODE
156701	7	200	8 pcs	3800123162251
156702	7	200	1000g	3800123162268
209909	11	300	1000g	3800123122354
209910	11	300	6 pcs	3800123122200

GLUE STICKS FOR GLUE GUNS BLACK

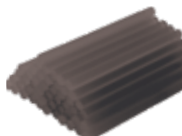

art. №	D1 (mm)	L1 (mm)	weight (g)	BARCODE
156703	7	200	8 pcs	3800123162275
156704	11	200	6 pcs	3800123162282
156705	11	300	1000g	3800123163357

INVERTER WELDING MACHINE RD-IW30

[BG] Инвертор • [RO] Aparat de sudura tip inverter • [SR] Aparat za zavarivanje
 • [МК] Инверторот • [RU] Сварочный аппарат • [SL] Varilni aparat • [EL] Ηλεκτροσυγκολλητής
 • [HR] Aparat za varenje inverter [FR] Poste à souder à inverseur • [IT] Saldatrice ad inverter
 • [ES] Inversta veldmašino • [PT] Soldadora inverter

230V (400V) ~ 50Hz	65 V
20-120 A	5.7 kVA
1.6 - 2.5 mm	3.7 kg
COLOR BOX	



Art.No	gross weight	barcode
077230	3.900 kg	3800972024267

INVERTER WELDING MACHINE RD-IW160 E-LINE

[BG] Инвертор • [RO] Aparat de sudura tip inverter • [SR] Aparat za zavarivanje
 • [МК] Инверторот • [RU] Сварочный аппарат • [SL] Varilni aparat • [EL] Ηλεκτροσυγκολλητής
 • [HR] Aparat za varenje inverter [FR] Poste à souder à inverseur • [IT] Saldatrice ad inverter
 • [ES] Inversta veldmašino • [PT] Soldadora inverter

230V (400V) ~ 50Hz	65 V
20-120 A	5.7 kVA
1.6 - 2.5 mm	3.7 kg
COLOR BOX	



Art.No	gross weight	barcode
077209	3.900 kg	3800972015623

INVERTER WELDING MACHINE RD-IW26

[BG] Инвертор • [RO] Aparat de sudura tip inverter • [SR] Aparat za zavarivanje
 • [МК] Инверторот • [RU] Сварочный аппарат • [SL] Varilni aparat • [EL] Ηλεκτροσυγκολλητής
 • [HR] Aparat za varenje inverter [FR] Poste à souder à inverseur • [IT] Saldatrice ad inverter
 • [ES] Inversta veldmašino • [PT] Soldadora inverter

230V (400V) ~ 50Hz	65 V
20-120 A	5.7 kVA
1.6 - 3.25 mm	2.860 kg
COLOR BOX	



Art.No	gross weight	in cartoon	barcode
077210	3.740 kg	4 pcs	3800972016248

INVERTER WELDING MACHINE RD-IW180 E-LINE

[BG] Инвертор • [RO] Aparat de sudura tip inverter • [SR] Aparat za zavarivanje
 • [МК] Инверторот • [RU] Сварочный аппарат • [SL] Varilni aparat • [EL] Ηλεκτροσυγκολλητής
 • [HR] Aparat za varenje inverter [FR] Poste à souder à inverseur • [IT] Saldatrice ad inverter
 • [ES] Inversta veldmašino • [PT] Soldadora inverter

230V~ 50Hz	65 V
20-160 A	4.9 kVA
2-4 mm	3.450 kg
COLOR BOX	



Art.No	gross weight	in cartoon	barcode
077213	5.300 kg		3800972016279

INVERTER WELDING MACHINE RD-IW25

[BG] Инвертор • [RO] Aparat de sudura tip inverter • [SR] Aparat za zavarivanje
 • [МК] Инверторот • [RU] Сварочный аппарат • [SL] Varilni aparat • [EL] Ηλεκτροσυγκολλητής
 • [HR] Aparat za varenje inverter [FR] Poste à souder à inverseur • [IT] Saldatrice ad inverter
 • [ES] Inversta veldmašino • [PT] Soldadora inverter

230V (400V) ~ 50Hz	19 V
20-160 A	5.7 kVA
1.6-3.25mm	4.5 kg
COLOR BOX	



Art.No	gross weight	in cartoon	barcode
077212	5.010 kg	4 pcs	3800972016262

INVERTER WELDING MACHINE RD-IW19

[BG] Инвертор • [RO] Aparat de sudura tip inverter • [SR] Aparat za zavarivanje
 • [МК] Инверторот • [RU] Сварочный аппарат • [SL] Varilni aparat • [EL] Ηλεκτροσυγκολλητής
 • [HR] Aparat za varenje inverter [FR] Poste à souder à inverseur • [IT] Saldatrice ad inverter
 • [ES] Inversta veldmašino • [PT] Soldadora inverter

230V (400V) ~ 50Hz	65 V
20-160 A	6.1 kVA
1.6 - 4.0mm	4 kg
COLOR BOX	



Art.No	gross weight	in cartoon	barcode
077204	4.500 kg	4 pcs	3800123171826

INVERTER WELDING MACHINE RD-IW31

[BG] Инвертор • [RO] Aparat de sudura tip inverter • [SR] Aparat za zavarivanje
 • [MK] Инверторот • [RU] Сварочный аппарат • [SL] Varilni aparat • [EL] Ηλεκτροσυγκολλησεις
 • [HR] Aparat za varenje inverter [FR] Poste à souder à inverter • [IT] Saldatrice ad inverter
 • [ES] Inversta veldmašino • [PT] Soldadora inverter

230V~
50Hz

65
V

20-180
A

5.6
kVA



Art.No	gross weight	barcode
077231	5.500 kg	3800972026605

INVERTER WELDING MACHINE RD-IW220 E-LINE

[BG] Инвертор • [RO] Aparat de sudura tip inverter • [SR] Aparat za zavarivanje
 • [MK] Инверторот • [RU] Сварочный аппарат • [SL] Varilni aparat • [EL] Ηλεκτροσυγκολλησεις
 • [HR] Aparat za varenje inverter [FR] Poste à souder à inverter • [IT] Saldatrice ad inverter
 • [ES] Inversta veldmašino • [PT] Soldadora inverter

230V~
50Hz

65
V

20-200
A

5.8
kVA

2-4mm

4.8
kg

COLOR BOX



Art.No	gross weight	barcode
077214	5.500 kg	3800972016286



INVERTER WELDING MACHINE RD-IW24

[BG] Инвертор • [RO] Aparat de sudura tip inverter • [SR] Aparat za zavarivanje
 • [MK] Инверторот • [RU] Сварочный аппарат • [SL] Varilni aparat • [EL] Ηλεκτροσυγκολλησεις
 • [HR] Aparat za varenje inverter [FR] Poste à souder à inverter • [IT] Saldatrice ad inverter
 • [ES] Inversta veldmašino • [PT] Soldadora inverter

230V
(400V)
~50Hz

62
V

20-200
A

5.7
kVA

1.6-4mm

5.4
kg

COLOR BOX



Art.No	gross weight	in cartoon	barcode
077211	6.000 kg	2 pcs	3800972016255



INVERTER WELDING MACHINE RDP-IW15

[BG] Инвертор • [RO] Aparat de sudura tip inverter • [SR] Aparat za zavarivanje
 • [MK] Инверторот • [RU] Сварочный аппарат • [SL] Varilni aparat • [EL] Ηλεκτροσυγκολλησεις
 • [HR] Aparat za varenje inverter [FR] Poste à souder à inverter • [IT] Saldatrice ad inverter
 • [ES] Inversta veldmašino • [PT] Soldadora inverter

230V~
50Hz

56
V

10-200
A

7
kVA

Ø1.6-5mm

8.200 kg

COLOR BOX



Art.No	gross weight	in cartoon	barcode
123302	9.000 kg		3800123135212

RAIDER[®]
Pro

INVERTER WELDING MACHINE FOR GENERATOR RDP-IW23

[BG] Инверторен заваръчен апарат за генератор • [RO] Aparat de sudura • [SR] Aparat za zavarivanje
 • [MK] Инверторот • [RU] Инверторный сварочный аппарат для генератора
 • [SL] Inverter varilni stroj za generator • [EL] Μηχανή συγκόλλησης αντιστροφεία για γεννήτρια
 • [HR] Inverter aparat za zavarivanje generatora • [FR] Poste à souder à inverter pour générateur
 • [IT] Saldatrice ad inverter per generatore • [ES] Kontrolni soldatšino por generatore
 • [PT] Soldadora inverter

230V~
50Hz

62
V

20-200
A

7.8
kVA

Ø1.8-4mm

3.63 kg

COLOR BOX



Art.No	gross weight	in cartoon	barcode
077208	4.900 kg	2 pcs	3800972004207

RAIDER[®]
Pro

INVERTER WELDING MACHINE 2IN1 MIG/MAG&MMA RD-IW27

[BG] Инвертор • [RO] Aparat de sudura tip inverter • [SR] Aparat za zavarivanje
 • [MK] Инверторот • [RU] Сварочный аппарат • [SL] Varilni aparat • [EL] Ηλεκτροσυγκολλησεις
 • [HR] Aparat za varenje inverter [FR] Poste à souder à inverter • [IT] Saldatrice ad inverter
 • [ES] Inversta veldmašino • [PT] Soldadora inverter

230V~
50Hz

25.2
V

30-130
A

9.0 kg

Ø1.6-4 mm

COLOR BOX



Art.No	gross weight	in cartoon	barcode
077227	11.0 kg		3800972020122

INVERTER WELDING MACHINE 2IN1 MIG/MAG&MMA RD-IW28

[BG] Инвертор • [RO] Aparat de sudura tip inverter • [SR] Aparat za zavarivanje
 • [MK] Инверторот • [RU] Сварочный аппарат • [SL] Varilni aparat • [EL] Ηλεκτροσυγκολλητής
 • [HR] Aparat za varenje inverter [FR] Poste à souder à inverseur • [IT] Saldatrice ad inverter
 • [ES] Inversta veldmašino • [PT] Soldadora inverter

 230V~
50Hz

**26
V**
**50-160
A**

14.400 kg



Ø1.6-4mm



COLOR BOX



Art.No	gross weight	in cartoon	barcode
077228	16.0 kg		3800972020139

INVERTER PLASMA CUTTING MACHINE RD-PCM29

[BG] Инвертор • [RO] Aparat de sudura tip inverter • [SR] Aparat za zavarivanje
 • [MK] Инверторот • [RU] Сварочный аппарат • [SL] Varilni aparat • [EL] Ηλεκτροσυγκολλητής
 • [HR] Aparat za varenje inverter [FR] Poste à souder à inverseur • [IT] Saldatrice ad inverter
 • [ES] Inversta veldmašino • [PT] Soldadora inverter

 230V~
50Hz

**96
V**
**10-40
A**

16.2 kg



COLOR BOX



Art.No	gross weight	in cartoon	barcode
077229	18.0 kg		3800972020146

WELDING HELMET AUTO-DARKENING RD-WH05

[BG] Шлем заваръчен фотосоларен • [RO] Masca de sudura • [SR] Maska za zavarivanje
 automatik • [MK] Самозатемнувачка кацига за заварување • [RU] Сварочный шлем • [SL] Avto-
 matska čelada za varjenje [EL] ΚίναΑυτόματη συγκόλλησης κράνος • [HR] Maska za Zavarivanje
 fotoosjetljiva automatska solarna • [FR] Casque de soudage • [IT] Casco per saldatura • [ES] Solda
 kasko • [PT] Capacete de soldar c/ escurecimento automático

**RO DESIGN
DIN 9-13**

 Light to
Dark
0.00004s

**0.250
kg**

Art.No	gross weight	in cartoon	barcode
138345	0.270 kg	6 pcs	3800972027848

WELDING HELMET AUTO-DARKENING RD-WH06

[BG] Шлем заваръчен фотосоларен • [RO] Masca de sudura • [SR] Maska za zavarivanje
 automatik • [MK] Самозатемнувачка кацига за заварување • [RU] Сварочный шлем • [SL] Avto-
 matska čelada za varjenje [EL] ΚίναΑυτόματη συγκόλλησης κράνος • [HR] Maska za Zavarivanje
 fotoosjetljiva automatska solarna • [FR] Casque de soudage • [IT] Casco per saldatura • [ES] Solda
 kasko • [PT] Capacete de soldar c/ escurecimento automático

**RO DESIGN
DIN 9-13**

 Light to
Dark
0.00004s

**0.250
kg**

Art.No	gross weight	in cartoon	barcode
138346	0.270 kg	6 pcs	3800972027855

WELDING HELMET AUTO-DARKENING RD-WH01

[BG] Шлем заваръчен фотосоларен • [RO] Masca de sudura • [SR] Maska za zavarivanje
 automatik • [MK] Самозатемнувачка кацига за заварување • [RU] Сварочный шлем • [SL] Avto-
 matska čelada za varjenje [EL] ΚίναΑυτόματη συγκόλλησης κράνος • [HR] Maska za Zavarivanje
 fotoosjetljiva automatska solarna • [FR] Casque de soudage • [IT] Casco per saldatura • [ES] Solda
 kasko • [PT] Capacete de soldar c/ escurecimento automático

- Optical class: 1/1/1/2
- Filter dimension: 110×90×9mm
- View size: 92×42mm
- Light state shade: DIN 4
- Dark state shade: DIN8/10/12, can be selected
- Switching time from Light to Dark: 1/25000 sec
- Sensitivity control: Low or high can be selected
- Delay time from Dark to Light: 0.2-0.5 sec.
- Arc sensors: 1

- TIG range: ≥ 35 amps/DC; ≥ 15 amps/AC
- UV/IR protection: Up to DIN 16 At all time
- Powered supply: Solar Cells + Sealed Lithium battery
- Power on/off: Full automatic
- Operate temp: -10°C + 55°C
- Storing temp: -20°C + 70°C
- Material: PP
- Approval: CE EN175 EN379
- N.W.: 445g

 Light to
Dark
0.00004s

**0.250
kg**

**2PCS
PROTECTIVE LENS
FREE OF CHARGE**
DIN 8/10/12

Art.No	gross weight	in cartoon	barcode
138301	0.270 kg	6 pcs	3800123174278



WELDING HELMET AUTO-DARKENING RD-WH02

[BG] Шлем заваръчен фотосолярен • [RO] Masca de sudura • [SR] Maska za zavarivanje automatik • [MK] Самозатемнувачка кацига за заварување • [RU] Сварочный шлем • [SL] Avtomatska čelada za varjenje [EL] ΚίναΑυτόματη συγκόλλησης κράνος • [HR] Maska za Zavarivanje fotoosjetljiva automatska solarna • [FR] Casque de soudage • [IT] Casco per saldatura • [ES] Solda kasko • [PT] Capacete de soldar c/ escurecimento automático

- Optical class: 1/1/1/2
- Filter dimension: 110×90×9mm
- View size: 92×42mm
- Light state shade: DIN 4
- Dark state shade: DIN 9-13, Stepless adjusted
- Switching time from Light to Dark: 1/25000sec
- Sensitivity control: Adjustable from Low to high
- Delay time from Dark to Light: Adjustable from 0.2 sec. (fast) to 1.0 sec. (slow)
- Arc sensors: 2
- TIG range: ≥ 35 amps/DC; ≥ 15 amps/AC
- GRINDING function: Yes
- UV/IR protection: Up to DIN 16 At all time
- Powered supply: Solar Cells + Sealed Lithium battery
- Power on/off: Full automatic
- Operate temp: -10°C + 55°C
- Storing temp: -20°C + 70°C
- Material: PP
- Approval: CE EN175 EN379
- N.W.: 465g



2PCS
PROTECTIVE LENS
FREE OF CHARGE
DIN 9-13

Art.No	gross weight	in cartoon	barcode
138302	0.270 kg	6 pcs	3800123174285

WELDING HELMET AUTO-DARKENING RD-WH03

[BG] Шлем заваръчен фотосолярен • [RO] Masca de sudura • [SR] Maska za zavarivanje automatik • [MK] Самозатемнувачка кацига за заварување • [RU] Сварочный шлем • [SL] Avtomatska čelada za varjenje [EL] ΚίναΑυτόματη συγκόλλησης κράνος • [HR] Maska za Zavarivanje fotoosjetljiva automatska solarna • [FR] Casque de soudage • [IT] Casco per saldatura • [ES] Solda kasko • [PT] Capacete de soldar c/ escurecimento automático

- Optical class: 1/1/1/2
- Filter dimension: 110×90×9mm
- View size: 92×42mm
- Light state shade: DIN 4
- Dark state shade: DIN 9-13, Stepless adjusted
- Switching time from Light to Dark: 1/25000sec
- Sensitivity control: Adjustable from Low to high
- Delay time from Dark to Light: Adjustable from 0.2 sec. (fast) to 1.0 sec. (slow)
- Arc sensors: 2
- TIG range: ≥ 35 amps/DC; ≥ 15 amps/AC
- GRINDING function: Yes
- UV/IR protection: Up to DIN 16 At all time
- Powered supply: Solar Cells + Sealed Lithium battery
- Power on/off: Full automatic
- Operate temp: -10°C + 55°C
- Storing temp: -20°C + 70°C
- Material: PP
- Approval: CE EN175 EN379
- N.W.: 465g



BG DESIGN
DIN 9-13

Art.No	gross weight	in cartoon	barcode
138307	0.270 kg	6 pcs	3800972004405

WELDING HELMET AUTO-DARKENING RD-WH07

[BG] Шлем заваръчен фотосолярен • [RO] Masca de sudura • [SR] Maska za zavarivanje automatik • [MK] Самозатемнувачка кацига за заварување • [RU] Сварочный шлем • [SL] Avtomatska čelada za varjenje [EL] ΚίναΑυτόματη συγκόλλησης κράνος • [HR] Maska za Zavarivanje fotoosjetljiva automatska solarna • [FR] Casque de soudage • [IT] Casco per saldatura • [ES] Solda kasko • [PT] Capacete de soldar c/ escurecimento automático



BG DESIGN
DIN 9-13

Art.No	gross weight	in cartoon	barcode
138347	0.270 kg	6 pcs	3800972027862

WELDING HELMET AUTO-DARKENING RD-WH04

[BG] Шлем заваръчен фотосолярен • [RO] Masca de sudura • [SR] Maska za zavarivanje automatik • [MK] Самозатемнувачка кацига за заварување • [RU] Сварочный шлем • [SL] Avtomatska čelada za varjenje [EL] ΚίναΑυτόματη συγκόλλησης κράνος • [HR] Maska za Zavarivanje fotoosjetljiva automatska solarna • [FR] Casque de soudage • [IT] Casco per saldatura • [ES] Solda kasko • [PT] Capacete de soldar c/ escurecimento automático

- Optical class: 1/1/1/2
- Filter dimension: 110×90×9mm
- View size: 92×42mm
- Light state shade: DIN 4
- Dark state shade: DIN 9-13, Stepless adjusted
- Switching time from Light to Dark: 1/25000sec
- Sensitivity control: Adjustable from Low to high
- Delay time from Dark to Light: Adjustable from 0.2 sec. (fast) to 1.0 sec. (slow)
- Arc sensors: 2
- TIG range: ≥ 35 amps/DC; ≥ 15 amps/AC
- GRINDING function: Yes
- UV/IR protection: Up to DIN 16 At all time
- Powered supply: Solar Cells + Sealed Lithium battery
- Power on/off: Full automatic
- Operate temp: -10°C + 55°C
- Storing temp: -20°C + 70°C
- Material: PP
- Approval: CE EN175 EN379
- N.W.: 465g



RO DESIGN
DIN 9-13

Art.No	gross weight	in cartoon	barcode
138309	0.270 kg	6 pcs	3800972010260

WELDING FILTER WITH SOLAR CELLS FOR WELDING HELMET

[BG] Филтър за заваръчен шлем RAIDER • [RO] Filtru pentru masca de sudura • [SR] Filter za maska za zavarivanje automatik • [MK] Филтер за самозатемнувачка кацига за заварување • [RU] Фильтр для сварочный шлем • [SL] Filter za avtomatska čelada za varjenje • [EL] Φίλτρο ΚίναΑυτόματη συγκόλλησης κράνος • [HR] Filter za kaciga za zavarivanje • [FR] Filtre de soudage avec cellules solaires • [IT] Filtro per saldatura con celle solari per casco di saldatura • [ES] Soldata Filtrilo Kun Sunaj Čeloj Por Soldado-Kasko • [PT] Filtro de soldagem com células solares para capacete de soldagem



DIN 9-13

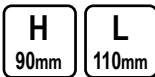
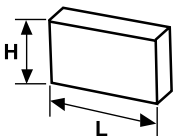

Art.No	gross weight	in cartoon	barcode
138305	0.130 kg	50 pcs	3800123174315

FRONT PROTECTIVE LENS FOR WELDING HELMET 5 PCS.

[BG] Екран външен предпазен за шлем RAIDER • [RO] Lentila frontala de protectie pentru masca de sudura • [SR] Prednje zaštitno staklo za maska za zavarivanje automatik • [MK] Предно заштитно стакло за самозатемнувачка кацига за заварување • [RU] Передний защитное стекло для сварочный шлем • [SL] Sprednja zaščitna stekla za avtomatska čelada za varjenje • [EL] Εμπρός προστατευτικό γυαλί ΚίναΑυτόματη συγκόλλησης κράνος • [HR] Prednja zaštitna stakla za kaciga za zavarivanje • [FR] Lentille de protection avant pour casque de soudeur • [IT] Lente protettiva frontale per casco di saldatura • [ES] Antaia protekta lenso por veldi kaskon • [PT] Lente de proteção frontal para capacete de soldagem

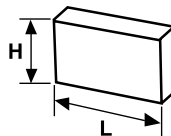

art. №	L	H	barcode
138303 for RD-WH01	113	89	3800123174292
138306 for RD-WH02	3m	2 T	3800123174322

INSIDE PROTECTIVE LENS FOR WELDING HELMET 5 PCS.

[BG] Екран вътрешен предпазен за шлем RAIDER • [RO] Lentila interna de protectie pentru masca de sudura • [SR] Interni zaštitno staklo za maska za zavarivanje automatik • [MK] Внатрешно заштитно стакло за самозатемнувачка кацига за заварување • [RU] Внутреннее защитное стекло для сварочный шлем • [SL] Notranji zaščitna stekla za avtomatska čelada za varjenje • [EL] Εσωτερικός προστατευτικό γυαλί ΚίναΑυτόματη συγκόλλησης κράνος • [HR] Interno zaštitno staklo za kaciga za zavarivanje • [FR] Lentille de protection intérieure pour casque de soudage • [IT] Lente protettiva interna per casco per saldatura • [ES] Ene de protekta lenso Por Soldado-Kasko • [PT] Lente protetora interna para capacete de soldagem

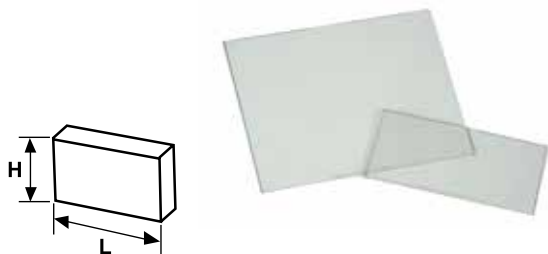

H
46.4mm

L
100.4mm

Art.No	gross weight	in cartoon	barcode
138304	0.010 kg	400 pcs	3800123174308

ELECTRODE HOLDER

[BG] Ръкохватка за заваряване с електроди • [RO] Cleste electrozi sudura • [SR] Držač elektrode • [MK] Држач за заварување • [RU] Держатель электродов • [SL] Elektro varilni ročaji • [EL] Τσιμπίδα ηλεκτροδίου • [HR] Držač elektrode za zavarivanje sa oprugom • [FR] Porte-électrode • [IT] Portaelettrodo • [ES] Elektrodo-posedanto • [PT] Suporte do eletrodo



COLOR BOX

art. №	A	BARCODE
499923	300	3800123104138
499924	500	3800123104121

EARTH CLAMP

[BG] Щипка за маса за електрожен • [RO] Cleste prindere ptr impamantare • [SR] Klešta za uzemljenje • [MK] Клешта за заземлување • [RU] Зажим для заземления • [SL] Klešče za maso • [EL] Σωμα ηλεκτροσυγκόλλησης • [HR] Klijesti za masu • [FR] Pince de terre • [IT] Morsetto di terra • [ES] Trancajo de tero • [PT] Braçadeira da terra



500
A

COLOR BOX

Art.No	barcode
499930	3800123104145

ELECTRODE HOLDER & PLUG WITH WELDING CABLE

[BG] Ръкохватка за заваряване с електроди • [RO] Cleste electrozi sudura • [SR] Držač elektrode • [MK] Држач за заварување • [RU] Держатель электродов • [SL] Elektro varilni ročaji • [EL] Τσιμπίδα ηλεκτροδίου • [HR] Držač elektrode za zavarivanje sa oprugom • [FR] Porte-électrode • [IT] Portaelettrodo • [ES] Elektrodo-posedanto • [PT] Suporte do eletrodo



Art.No	barcode
138343	3800972023697

EARTH CLAMP & PLUG WITH WELDING CABLE

[BG] Щипка за маса за електрожен • [RO] Cleste prindere ptr impamantare • [SR] Klešta za uzemljenje • [MK] Клешта за заземлување • [RU] Зажим для заземления • [SL] Klešče za maso • [EL] Σωμα ηλεκτροσυγκόλλησης • [HR] Klijesti za masu • [FR] Pince de terre • [IT] Morsetto di terra • [ES] Trancajo de tero • [PT] Braçadeira da terra



Art.No	barcode
138344	3800972023703

ARROW MAGNET WELDING HOLDER

[BG] Магнитен ъгъл държач • [RO] Suport magnetic pentru sudura in unghi • [SR] Stezač magnetnog • [MK] Магнетн ъгъл държач • [RU] Магнитный держатель углов • [SL] Nosilec magnetnega kota • [EL] Μαγνητική γωνιακή βάση • [HR] Stezač magnetnog • [FR] Titulaire d'angle magnétique • [IT] Supporto magnetico per saldatura a freccia • [ES] Magneta angula holder • [PT] Suporte de ângulo magnético



Art. No. 130340



Art. No. 130341



Art. No. 130342

art. №	Size (mm)	Grade 0	Weight (kg)	BARCODE
138340	120x80x14mm	45° 90° 135°	11	3800972009752
138341	155x102x16mm	45° 90° 135°	22	3800972009769
138342	155x76mm	165° 60° 90° 135° 120° 15° 45°	11	3800972009776

MAGNET TORPEDO LEVEL 230 MM 3 VIALS RAIDER

[BG] Нивелир с магнит 230 mm 3 либели • [RO] Magnet level 230 mm 3 lilie • [SR] Nivo magneta 230 mm 3 lilie • [MK] Ниво на магнет 230 mm 3 Лили • [RU] Магнитный уровень 230 mm 3 лили • [SL] Magnetna raven 230 mm 3 lilie [EL] Επίπεδο μαγνήτη 230 mm 3 Lilie • [HR] Razina magnetna 230 mm 3 lilie • [FR] Magnet Niveau 230 mm 3 Lilie • [IT] Livello magnetico 230 mm 3 Lilie • [ES] Magnet Nivel 230 mm 3 Lilie • [PT] Nivel de imã 230 mm 3 Lilie



Art.No	barcode
549789	3800972002210

ELECTRIC HOIST

[BG] Телфер електрически • [RO] Macara electrica • [SR] Dizalica električna • [MK] Електрична дигалка • [RU] Электрическая лебедка [SL] Električno vzvodno dvigalo • [EL] Ηλεκτρικά Βαρουλκά • [HR] Dizalica konzolna električna • [FR] Palan électrique • [IT] Paranco elettrico • [ES] Elektra šaržilo • [PT] Guincho elétrico

230V~
50Hz



art. №	W	M	Ø	max load with pulley	max load without pulley	BARCODE
121101 RD-EH01	510	6-12m	3.2mm	250kg	125kg	3800123120169
121102 RD-EH02	1020	6-12m	4.2mm	500kg	250kg	3800123120084

ELECTRIC HOIST RD-EH03

[BG] Телфер електрически • [RO] Macara electrica • [SR] Dizalica električna • [MK] Електрична дигалка • [RU] Электрическая лебедка [SL] Električno vzvodno dvigalo • [EL] Ηλεκτρικά Βαρουλκά • [HR] Dizalica konzolna električna • [FR] Palan électrique • [IT] Paranco elettrico • [ES] Elektra šaržilo • [PT] Guincho elétrico

230V~
50Hz

1600
W

6-12 m

Ø5.7 mm

1000kg
max
LOAD
WITH PULLEY

500kg
max
LOAD
WITHOUT PULLEY

29
kg



Art.No	gross weight	barcode
121103	32.390 kg	3800123120091

ELECTRIC HOIST TROLLEY

[BG] Електрическа количка за повдигане • [RO] Cărucior de ridicare electric • [SR] Električna kolica • [MK] Количка за електрична дигалка • [RU] Тележка электрическая лебедка • [SL] Električni voziček za dvigalo • [EL] Ηλεκτρικό φορτίο ανύψωσης • [HR] Kolica s električnim podizanjem • [FR] Chariot élévateur électrique • [IT] Carrello paranco elettrico • [ES] Elektra širmilo • [PT] Carrinho de elevação elétrico

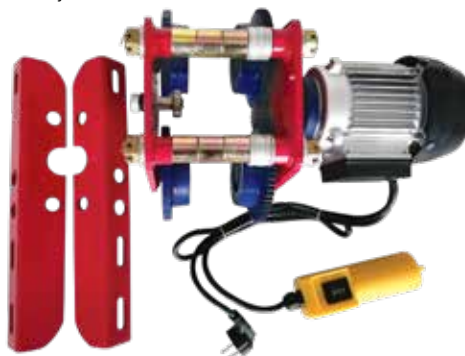

art. №	W	capacity	max load	BARCODE
079201 RD-EH05	60	13m/min	0.5 T	3800972016217
079202 RD-EH06	300	13m/min	1 T	3800972016224

CHAIN BLOCK

[BG] Лебедка с верига • [RO] Scripete manual • [SR] Dizalica Lančana • [MK] Дигалка со ланец • [RU] Цепной блок • [SL] Vitel Ročni z verige • [EL] Χειροκίνητο βαρούλκο με αλυσίδα • [HR] Dizalica Lančana • [FR] Bloc chaîne • [IT] Blocco a catena • [ES] Čeno bloko • [PT] Bloqueio da cadeia



art. №	length	max load	weight	BARCODE
300401with one chain RD-CB01	3m	1 T	10 kg	3800123120183
300402 RD-CB02	3m	2 T	12 kg	3800123120206
300403 RD-CB03	3m	3 T	20 kg	3800123120039

ELECTRIC WINCH RD-EW05

[BG] Автолебедка • [RO] Trolu electric • [SR] Električno vitlo • [MK] Електрично витло • [RU] Электрическая лебедка грузовик • [SL] Električni vitel • [EL] Αυτοματής ηλεκτρικά βαρούλκο • [HR] Električna dizalica • [FR] Dizalica konzolna električna • [FR] Treuil électrique • [IT] Verricello elettrico [ES] Elektra turbo • [PT] Guincho elétrico

12
V

2200
W

1360kg
max
LOAD

7.250
kg

14 m

Ø4.8mm

COLOR BOX



Art.No	gross weight	in cartoon	barcode
121605	9.430 kg		3800123120077

ELECTRIC WINCH RD-EW06

[BG] Автолебедка • [RO] Troliu electric • [SR] Električno vitlo • [MK] Електрично витло
 • [RU] Электрическая лебедка грузовик • [SL] Električni vitel • [EL] Αυτομάτης ηλεκτρικά
 βάρουλο • [HR] Električna dizalica • [HR] Dizalica konzolna električna • [FR] Treuil électrique
 • [IT] Verricello elettrico [ES] Elektra turbo • [PT] Guincho eléctrico



Art.No	gross weight	in cartoon	barcode
121606	18.560 kg		3800123120114

ELECTRIC WINCH RD-EW07

[BG] Автолебедка • [RO] Troliu electric • [SR] Električno vitlo • [MK] Електрично витло
 • [RU] Электрическая лебедка грузовик • [SL] Električni vitel • [EL] Αυτομάτης ηλεκτρικά
 βάρουλο • [HR] Električna dizalica • [HR] Dizalica konzolna električna • [FR] Treuil électrique
 • [IT] Verricello elettrico [ES] Elektra turbo • [PT] Guincho eléctrico

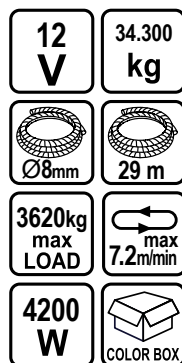

Art.No	gross weight	in cartoon	barcode
121608	35.800 kg		3800123119934

INVERTER BATTERY CHARGER RD-BC13

[BG] Зарядно за акумулатор инверторно • [RO] Redresor auto digital • [SR] Punjač akumulatora
 • [MK] Полнач за акумулатор • [RU] Зарядное устройство инвертор для аккумуляторов • [SL] Polnillec za
 Baterije • [EL] Φορτιστής μπαταριών • [HR] Inverter baterijski punjač • [FR] Chargeur de
 batterie inverter • [IT] Carica batterie inverter • [ES] Insura batteria kargero • [PT] Carregador de
 bateria do inversor

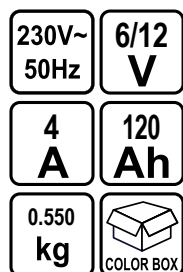

- Battery charge level indicator
 - Charges automobile batteries up to 120 Ah
 - Automatically switches off when the full battery charge is reached
 - 8 programs
 - Can be used to support boat accumulators, jets, etc. machines that are not used in the winter
 - Charges both classic lead acid batteries and the latest WET MF, GEL, AGM, Ca-Ca batteries.
- This charger can also revive a very exhausted battery.
 The following protections are built in:
1. overload protection;
 2. protection against polarity reversal;
 3. short-circuit protection of the terminals;
- Degree of protection IP 65 for outdoor use

Art.No	gross weight	in cartoon	barcode
032202	0.700 kg	4 pcs	3800972002951

BATTERY CHARGER RD-BC05

[BG] Зарядно за акумулатор • [RO] Incarcator acumulator • [SR] Punjač akumulatora
 • [MK] Полнач за акумулатор • [RU] Зарядное устройство для аккумуляторов • [SL] Polnillec za
 Baterije • [EL] Φορτιστής Μπαταριών • [HR] Punjač Akumulatora • [FR] Chargeur de batterie
 • [IT] Caricabatterie • [ES] Šargilo • [PT] Carregador de bateria

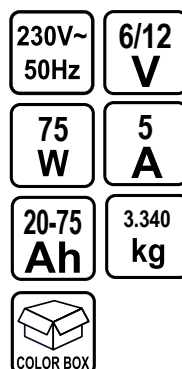

Art.No	gross weight	in cartoon	barcode
032201	3.700 kg	4 pcs	3800123162299

BATTERY CHARGER RD-BC10

[BG] Зарядно за акумулатор • [RO] Incarcator acumulator • [SR] Punjač akumulatora
 • [MK] Полнач за акумулатор • [RU] Зарядное устройство для аккумуляторов • [SL] Polnillec za
 Baterije • [EL] Φορτιστής Μπαταριών • [HR] Punjač Akumulatora • [FR] Chargeur de batterie
 • [IT] Caricabatterie • [ES] Šargilo • [PT] Carregador de bateria

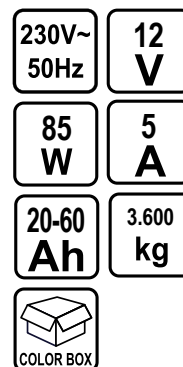

Art.No	gross weight	in cartoon	barcode
129962	4.120 kg	4 pcs	3800123152153

BATTERY CHARGER RD-BC12

[BG] Зарядно за акумулатор • [RO] Incarcator acumulator • [SR] Punjač akumulatora
 • [MK] Полнач за акумулатор • [RU] Зарядное устройство для аккумуляторов • [SL] Polnillec za
 Baterije • [EL] Φορτιστής Μπαταριών • [HR] Punjač Akumulatora • [FR] Chargeur de batterie
 • [IT] Caricabatterie • [ES] Šargilo • [PT] Carregador de bateria

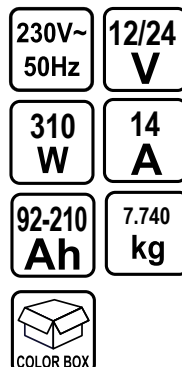

Art.No	gross weight	in cartoon	barcode
129964	8.620 kg	4 pcs	3800123152177

BATTERY CHARGER RD-BC11

[BG] Зарядно за акумулатор • [RO] Incarcator acumulator • [SR] Punjač akumulatora
 • [MK] Полнач за акумулатор • [RU] Зарядное устройство для аккумуляторов • [SL] Polnillec Za Baterije • [EL] Φορτιστής Μπαταριών • [HR] Punjač Akumulatora • [FR] Chargeur de batterie
 • [IT] Caricabatterie • [ES] Šargilo • [PT] Carregador de bateria

230V~ 50Hz	12/24 V
110 W	9 A
25-135 Ah	4.165 kg
COLOR BOX	



Art.No	gross weight	in cartoon	barcode
129963	4.700 kg	4 pcs	3800123152160

INVERTER BATTERY CHARGER LCD RD-BC17

[BG] Зарядно за акумулатор инверторно • [RO] Redresor auto digital • [SR] Punjač akumulatora
 • [MK] Полнач за акумулатор • [RU] Зарядное устройство инвертор для аккумуляторов • [SL] Polnillec baterij
 [EL] Φορτιστής μπαταριών • [HR] Inverter baterijski punjač • [FR] Chargeur de batterie inverter
 • [IT] Carica batterie inverter • [ES] Insura batteria kargero • [PT] Carregador de bateria do inversor

230V~ 50Hz	6/12 V
110 W	10 A
45 Ah	4.165 kg
COLOR BOX	



Art.No	gross weight	in cartoon	barcode
032206	4.700 kg	4 pcs	3800972027879

INVERTER BATTERY CHARGER LCD RD-BC18

[BG] Зарядно за акумулатор инверторно • [RO] Redresor auto digital • [SR] Punjač akumulatora
 • [MK] Полнач за акумулатор • [RU] Зарядное устройство инвертор для аккумуляторов • [SL] Polnillec baterij
 [EL] Φορτιστής μπαταριών • [HR] Inverter baterijski punjač • [FR] Chargeur de batterie inverter
 • [IT] Carica batterie inverter • [ES] Insura batteria kargero • [PT] Carregador de bateria do inversor

230V~ 50Hz	6/12 V
110 W	10 A
75 Ah	4.165 kg
COLOR BOX	



Art.No	gross weight	in cartoon	barcode
032207	4.700 kg	4 pcs	3800972027886

INVERTER BATTERY CHARGER LCD RD-BC19

[BG] Зарядно за акумулатор инверторно • [RO] Redresor auto digital • [SR] Punjač akumulatora
 • [MK] Полнач за акумулатор • [RU] Зарядное устройство инвертор для аккумуляторов • [SL] Polnillec baterij
 [EL] Φορτιστής μπαταριών • [HR] Inverter baterijski punjač • [FR] Chargeur de batterie inverter
 • [IT] Carica batterie inverter • [ES] Insura batteria kargero • [PT] Carregador de bateria do inversor

230V~ 50Hz	12/24 V
110 W	10 A
200 Ah	4.165 kg
COLOR BOX	



Art.No	gross weight	in cartoon	barcode
032208	4.700 kg	4 pcs	3800972027893

JUMP STARTER&POWER SUPPLY RD-JBC15

[BG] Зарядно стартерна батерия • [RO] Redresor auto digital • [SR] Punjač akumulatora • [MK] Полнач за акумулатор
 • [RU] Зарядное устройство инвертор для аккумуляторов • [SL] Polnillec baterij [EL] Φορτιστής μπαταριών
 • [HR] Inverter baterijski punjač • [FR] Chargeur de batterie inverter • [IT] Carica batterie inverter
 • [ES] Insura batteria kargero • [PT] Carregador de bateria do inversor

230V~ 50Hz	12/24 V
110 W	300 A
64 Ah	4.165 kg
COLOR BOX	



Art.No	gross weight	in cartoon	barcode
032204	4.700 kg	4 pcs	3800972002975

JUMP STARTER&POWER SUPPLY RD-JBC16

[BG] Зарядно стартерна батерия • [RO] Redresor auto digital • [SR] Punjač akumulatora • [MK] Полнач за акумулатор
 • [RU] Зарядное устройство инвертор для аккумуляторов • [SL] Polnillec baterij [EL] Φορτιστής μπαταριών
 • [HR] Inverter baterijski punjač • [FR] Chargeur de batterie inverter • [IT] Carica batterie inverter
 • [ES] Insura batteria kargero • [PT] Carregador de bateria do inversor

230V~ 50Hz	12/24 V
110 W	450 A
8 Ah	4.165 kg
COLOR BOX	



Art.No	gross weight	in cartoon	barcode
032205	4.700 kg	4 pcs	3800972002982

JUMP STARTER&POWER SUPPLY RD-JBC20

[BG] Зарядно стартерна батерия • [RO] Redresor auto digital • [SR] Punjač akumulatora • [MK] Полнач за акумулатор • [RU] Зарядное устройство инвертор для аккумуляторов • [SL] Polnilce baterij [EL] Φορτιστής μπαταριών • [HR] Inverter baterijski punjač • [FR] Chargeur de batterie inverter • [IT] Carica batterie inverter • [ES] Insura batería kargero • [PT] Carregador de bateria do inversor

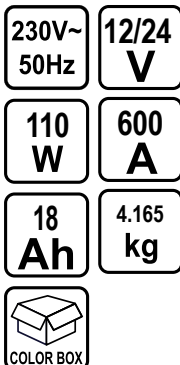

Art.No	gross weight	in cartoon	barcode
032209	4.700 kg	4 pcs	3800972027909

HYDRAULIC BOTTLE JACK

[BG] Крик хидравличен тип "бутылка" • [RO] Cric hidraulic • [SR] Hidrauličnu dizalicu tip "b flaša" • [MK] Хидраулична дигалка • [RU] Гидравлическая бутылка • [SL] Hidraulična dvigalka • [EL] Γρύλος αυτοκινήτου • [HR] Hidraulična dizalica • [FR] Bouteille hydraulique • [IT] Pressa per bottiglia idraulica [ES] Hidraúlika botela fanto • [PT] Macaco hidraulico



Art. №	Model	Load (tone)	WEIGHT KG	Barcode
300101	RD-HB02	2	2.2	3800123136016
300102	RD-HB03	3	3	3800123136023
300103	RD-HB04	4	3	3800123136030
300104	RD-HB05	5	4	3800123136047
300106	RD-HB10	10	5.4	3800123136061
300108	RD-HB15	15	7.5	3800123136085
300109	RD-HB20	20	9.9	3800123136092
300110	RD-HB32	32	13	3800123136108
300111	RD-HB50	50	21	3800123136115

TROLLEY JACK

[BG] Крик хидравличен тип "Крокодил" • [RO] Cric crocodil • [SR] Dizalica hidraulična krokodilka • [MK] Хидраулична крокодил дигалка • [RU] Гидравлический автомобильный домкрат • [SL] Hidraulična dvigalka na kolesih • [EL] Γρύλος Τρέιλερ αυτοκινήτου • [HR] Hidraulična dizalica • [FR] Vérin hydraulique • [IT] Pressa auto idraulica • [ES] Hidraúlika automóvil • [PT] Tomada do carro hidráulico



Art. №	Model	Load (tone)	min H mm	max H mm	Barcode
300201	RD-TJ01	2	130	300	3800123136139
300207	RD-TJ01	2	130	300	3800123136504
300202	RD-TJ02	2	125	390	3800123136146
300209	RD-TJ06	2	85	380	3800123163968
300205	RD-TJ04	3	138	420	3800123136245
300204	RD-TJ03	3	120	495	3800123136153
300208	RD-TJ05	3	135	500	3800123163845

FARM JACK RD-FJ01

[BG] Крик високоповдигащ • [RO] Cric H-Lift • [SR] Dizalica velika stora • [MK] Дигалка H-Lift • [RU] Домкрат реечный автомобильный • [SL] Dvigalo Ročno • [EL] Γρύλος αυτοκινήτου • [HR] Hi-lift dizalica • [FR] La prise est rack voiture • [IT] Il jack è rack automobilistico • [ES] La kato estas rako auto • [PT] O jack é rack de automóvel

MAX. HEIGHT 48" / 120 cm



3T

14 kg

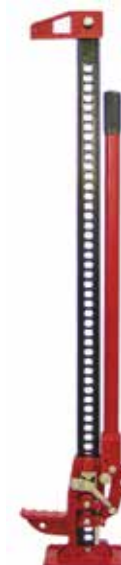

Art.No	gross weight	in cartoon	barcode
309904	12.650 kg		3800123173776

SCISSOR JACK

[BG] Крик винтов тип "жаба" • [RO] Cric foarfeca • [SR] Dizalica sa navojem • [MK] Рачна Дигалка • [RU] Ножничный подъемник • [SL] škarjasto Dvigalo • [EL] Γρύλος Μηχανικός • [HR] Trapez dizalica • [FR] La prise est rack voiture • [IT] Il jack è rack automobilistico • [ES] La kato estas rako auto • [PT] O jack é rack de automóvel



1T

2 kg



Art.No	gross weight	in cartoon	barcode
309903	2.080 kg	10 pcs	3800123154942

AXLE STANDS PAIR 2 PCS SET

[BG] Стойки за автомобил с гребен • [RO] Set 2 buc. cric hidraulic • [SR] Držač par • [MK] Држач • [RU] Стенды за автомобиль с гребнем • [SL] Stojalo za avto par • [EL] Βάσεις αυτοκινήτο • [HR] Podupirači • [FR] La prise est rack voiture • [IT] Il jack è rack automobilistico • [ES] La kato estas rako auto • [PT] O jack é rack de automóvel

2T

5 kg



Art.No	gross weight	in cartoon	barcode
300702	5.330 kg	6 pcs	3800123136214

HYDRAULIC BODY REPAIR KIT RD-PHE03

[BG] Разпъвачка хидравлична за автомобили • [RO] Echipament hidraulic • [SR] Autolimarska oprema za razvlačenje • [MK] Хидраулични комплет за исправање • [RU] Комплект гидравлический для рихтовки кузова • [SL] Komplet za popravilo udrtinna osnovi hidravlike • [EL] Σετ επισκευων υδραυλικων υπισκευων [HR] Autolimarska oprema za razvlačenje • [FR] Kit hydraulique pour le soutien du corps • [IT] Kit idraulico per la pastura del corpo • [ES] Hidraulica kit por korpoj • [PT] Kit esticador hidraulico

10T
22.6 kg



CAPACITY (TON)	STROKE (mm)	MIN. HEIGHT (mm)	MAX. HEIGHT (mm)
4	18	42	58
10	57	132	189
2	70	139	240
4	125	275	405
10	150	350	500
5	130	520	650

Art.No	gross weight	barcode
300612	23.600 kg	3800123173783

HYDRAULIC BODY REPAIR KIT RD-PHE04

[BG] Разпъвачка хидравлична за автомобили • [RO] Echipament hidraulic • [SR] Autolimarska oprema za razvlačenje • [MK] Хидраулични комплет за исправање • [RU] Комплект гидравлический для рихтовки кузова • [SL] Komplet za popravilo udrtinna osnovi hidravlike • [EL] Σετ επισκευων υδραυλικων υπισκευων [HR] Autolimarska oprema za razvlačenje • [FR] Kit hydraulique pour le soutien du corps • [IT] Kit idraulico per la pastura del corpo • [ES] Hidraulica kit por korpoj • [PT] Kit esticador hidraulico

10T
27 kg



CAPACITY (TON)	STROKE (mm)	MIN. HEIGHT (mm)	MAX. HEIGHT (mm)
4	18	42	58
10	57	132	189
2	70	139	240
4	120	275	395
10	135	325	460
5	155	345	500
20	145	325	470
15		250	420

Art.No	gross weight	barcode
300613	39.000 kg	3800972005679

HYDRAULIC BODY REPAIR KIT RD-PHE05

[BG] Разпъвачка хидравлична за автомобили • [RO] Echipament hidraulic • [SR] Autolimarska oprema za razvlačenje • [MK] Хидраулични комплет за исправање • [RU] Комплект гидравлический для рихтовки кузова • [SL] Komplet za popravilo udrtinna osnovi hidravlike • [EL] Σετ επισκευων υδραυλικων υπισκευων [HR] Autolimarska oprema za razvlačenje • [FR] Kit hydraulique pour le soutien du corps • [IT] Kit idraulico per la pastura del corpo • [ES] Hidraulica kit por korpoj • [PT] Kit esticador hidraulico

4T
17 kg



CAPACITY (TON)	STROKE (mm)	MIN. HEIGHT (mm)	MAX. HEIGHT (mm)
4	18	42	58
10	57	132	189
2	70	139	240
4	120	275	395
10	135	325	460
5	155	345	500
20	145	325	470
15		250	420

Art.No	gross weight	in carton	barcode
300614	18.000 kg	1	3800972005686

HYDRAULIC BODY REPAIR KIT RD-PHE06

[BG] Разпъвачка хидравлична за автомобили • [RO] Echipament hidraulic • [SR] Autolimarska oprema za razvlačenje • [MK] Хидраулични комплет за исправање • [RU] Комплект гидравлический для рихтовки кузова • [SL] Komplet za popravilo udrtinna osnovi hidravlike • [EL] Σετ επισκευων υδραυλικων υπισκευων [HR] Autolimarska oprema za razvlačenje • [FR] Kit hydraulique pour le soutien du corps • [IT] Kit idraulico per la pastura del corpo • [ES] Hidraulica kit por korpoj • [PT] Kit esticador hidraulico

15T
43 kg

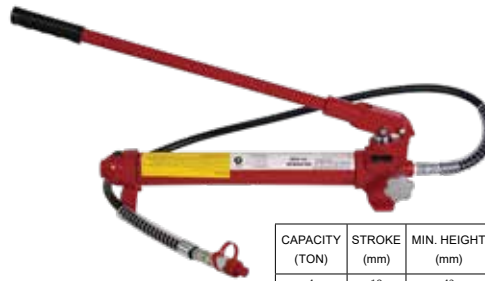

CAPACITY (TON)	STROKE (mm)	MIN. HEIGHT (mm)	MAX. HEIGHT (mm)
4	18	42	58
10	57	132	189
2	70	139	240
4	120	275	395
10	135	325	460
5	155	345	500
20	145	325	470
15		250	420

Art.No	gross weight	in carton	barcode
300615	33.000 kg	1	3800972005693

HYDRAULIC BODY REPAIR KIT RD-PHE07

[BG] Разпъвачка хидравлична за автомобили • [RO] Echipament hidraulic • [SR] Autolimarska oprema za razvlačenje • [MK] Хидраулични комплет за исправање • [RU] Комплект гидравлический для рихтовки кузова • [SL] Komplet za popravilo udrtinna osnovi hidravlike • [EL] Σετ επισκευων υδραυλικων υπισκευων [HR] Autolimarska oprema za razvlačenje • [FR] Kit hydraulique pour le soutien du corps • [IT] Kit idraulico per la pastura del corpo • [ES] Hidraulica kit por korpoj • [PT] Kit esticador hidraulico

20T
57 kg

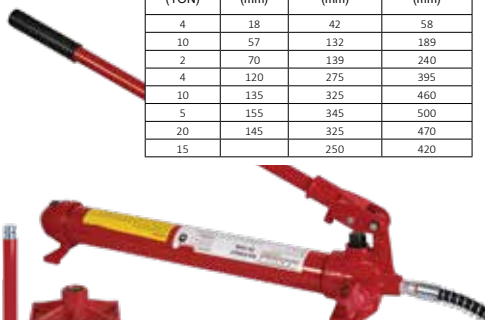

CAPACITY (TON)	STROKE (mm)	MIN. HEIGHT (mm)	MAX. HEIGHT (mm)
4	18	42	58
10	57	132	189
2	70	139	240
4	120	275	395
10	135	325	460
5	155	345	500
20	145	325	470
15		250	420

Art.No	gross weight	in carton	barcode
300616	58.000 kg	1	3800972005709

HYDRAULIC BENCH PRESS WITH PRESSURE GAUGE RD-HP02

[BG] Преса хидравлична настолна с манометър • [RO] Presa hidraulica • [SR] Hidraulična presa • [MK] Хидраулична преса • [RU] Пресс гидравлический настольный • [SL] Hidraulične stiskalnice • [EL] υδραυλική πρέσα • [HR] Ručna hidraulična preša • [FR] Presse de banc hydraulique avec manomètre • [IT] Banco da banco idraulico con manometro • [ES] Hidraulička benka gazetaro kun premometro • [PT] Prensa hidraulica

10T
50 kg



Art.No	gross weight	in carton	barcode
300604	50.700 kg	1	3800123173691

HYDRAULIC CYLINDER FOR HYDRAULIC BENCH PRESS WITH PRESSURE GAUGE 10T RD-HP02

[BG] Силов цилиндър • [RO] Cilindru de putere • [SR] Pover cilindar • [MK] Моќен цилиндар • [RU] Силовой цилиндр • [SL] Močni cilindar • [EL] Κύλινδρος ισχύος • [HR] Pogonski cilindar • [FR] Cylindre de puissance • [IT] Cilindro di potenza • [ES] Cilindro de potencia • [PT] Cilindro de potência



Art.No	gross weight	in carton	barcode
309907	--- kg	1	3800972025318

HYDRAULIC FLOOR PRESS RD-HP1

[BG] Преса хидравлична настолна • [RO] Presa hidraulica • [SR] Hidraulična presa • [MK] Хидраулична преса • [RU] Пресс гидравлический настольный • [SL] Hidravlične stiskalnice • [EL] Υδραυλική πρέσα • [HR] Ručna hidraulična preša • [FR] Presse de banc hydraulique [IT] Banco da banco idraulico • [ES] Hidraùlika benka • [PT] Prensa hidráulica



12T
42 kg

Art.No	gross weight	barcode
300603	42.500 kg	3800123128417

HYDRAULIC FLOOR PRESS RD-HP03

[BG] Преса хидравлична настолна • [RO] Presa hidraulica • [SR] Hidraulična presa • [MK] Хидраулична преса • [RU] Пресс гидравлический настольный • [SL] Hidravlične stiskalnice • [EL] Υδραυλική πρέσα • [HR] Ručna hidraulična preša • [FR] Presse de banc hydraulique [IT] Banco da banco idraulico • [ES] Hidraùlika benka • [PT] Prensa hidráulica

12T
66 kg



Art.No	gross weight	barcode
300605	66.800 kg	3800123173707

HYDRAULIC CYLINDER FOR HYDRAULIC PRESS WITH PRESSURE GAUGE 12T RD-HP03

[BG] Силов цилиндър за преса • [RO] Cilindru hidraulic • [SR] Hidraulični cilindar • [MK] Хидрауличен цилиндар • [RU] Гидравлический цилиндр • [SL] Hidravlični cilindar • [EL] Υδραυλικός κύλινδρος • [HR] Hidraulični cilindar • [FR] Cylindre hydraulique • [IT] Cilindro idraulico • [ES] Cilindro hidráulico • [PT] Cilindro hidráulico



Art.No	gross weight	barcode
309908	--- kg	3800972025325

HYDRAULIC FLOOR PRESS RD-HP04

[BG] Преса хидравлична настолна • [RO] Presa hidraulica • [SR] Hidraulična presa • [MK] Хидраулична преса • [RU] Пресс гидравлический настольный • [SL] Hidravlične stiskalnice • [EL] Υδραυλική πρέσα • [HR] Ručna hidraulična preša • [FR] Presse de banc hydraulique [IT] Banco da banco idraulico • [ES] Hidraùlika benka • [PT] Prensa hidráulica



20T
86 kg

Art.No	gross weight	barcode
300606	86.800 kg	3800123173714

PNEUMATIC PRESS WITH PRESSURE GAUGE RD-HP05

[BG] Преса хидравлична с манометър и пневматично управление • [RO] Presa pneumatica cu manometru • [SR] Pnevmataska presa • [MK] Пневматски преса • [RU] Пресс пневматический настольный • [SL] Pnevmatске stiskalnice • [EL] Πνευματικός πρέσα • [HR] Ručna pnevmatska preša • [FR] Presse pneumatique de table • [IT] Pressa pneumatica da tavolo • [ES] Tabla pneumática gazetario • [PT] Prensa hidráulica



20T
86.5 kg

Art.No	gross weight	barcode
300607	88.000 kg	3800123173721

SINGLE CYLINDER TRANSMISSION JACK RD-TRJ01

[BG] Крик за скоростни кутии • [RO] Cric hidraulic pentru cutii de viteze • [SR] Dizalica za menjač • [MK] Дигалка за мењач • [RU] Домкрат трансмиссионные • [SL] Dvigalka za menjalnik • [EL] Γρύλος κιβώτιο ταχυτήτων • [HR] Dizalica za mjenjač • [FR] Cric de transmission monocylindre • [IT] Jack di trasmissione a singolo cilindro • [ES] Transdono jack • [PT] Jack de transmissão



567kg
max
LOAD

27.00
kg

Art.No	gross weight	barcode
300608	29.000 kg	3800123173738

ENGINE STAND RD-EST01

[BG] Стойка за двигатели • [RO] Suport pentru motor • [SR] Nosač motora • [MK] Држач за мотор • [RU] Стенд для двигателя • [SL] Stojalo za motor • [EL] Σταύτ Κινητήρα • [HR] Nosac motora • [FR] Stand pour les moteurs • [IT] Supporto per motori • [ES] Stari por motoroj • [PT] Suporte para motores



Art.No	gross weight	barcode
300609	27.000 kg	3800123173745

HYDRAULIC PIPE BLENDER RD-HPB01

[BG] Тръбогиб хидравличен • [RO] Dispozitiv hidraulic pentru indoit tevi • [SR] Savijač cevi hidraulični • [MK] Хидраулични Цевки Бендер • [RU] Трубогиб гидравлический • [SL] Navrični hidravlični stroj za krivljenje cevi • [EL] Υδραυλικός Κουρμπασόδορος Σωλήνων • [HR] Savijač cijevi hidraulički • [FR] Cintreuse hydraulique • [IT] Curvatubi idraulico • [ES] Hidraülিকা tubaro • [PT] Dobrador de tubo hidraulico



1/2" + 3/4" + 1" + 1 1/4" + 1 1/2" + 2"

12T



31.200
kg

Art.No	gross weight	barcode
300610	31.700 kg	3800123173752

HYDRAULIC GEAR PULLER 3 JAW RD-HGP01

[BG] Скоба за лагери трираменна хидравлична • [RO] Extractor hidraulic cutie de viteze • [SR] Hidraulični radapciger • [MK] Хидраулични извлекувач со 3 рамена • [RU] Гидравлические съёмник подшипников • [SL] Hidravlični snemalec 3 kos • [EL] Υδραυλικό σετ Εξολκέας • [HR] Hidraulični radapciger • [FR] Presse pneumatique de table • [IT] Pressa pneumatica da tavolo • [ES] Tabla pneumatica gazetaro • [PT] Saca-rolamentos hidraulico

5T



Art.No	gross weight	in carton	barcode
300611	5.880 kg	2 pcs	3800123173769

HYDRAULIC ENGINE HOIST RD-HEH01

[BG] Кран за повдигане на двигатели • [RO] Macara Hidraulica tip "Girafa" • [SR] Dizalica za podizanje motora • [MK] Кран за дигање на мотори • [RU] Кран гидравлический • [SL] Dvigalo motorjev • [EL] Υδραυλικός γερανός κινητήρων • [HR] Radionički Kran • [FR] Palan à moteur hydraulique • [IT] Paranco motore idraulico • [ES] Levilo de hidraülিকা motoro • [PT] Talha hidráulica do motor



1T

67
kg



Art.No	gross weight	barcode
309901	66.800 kg	3800123136221

HYDRAULIC CYLINDER FOR HYDRAULIC ENGINE HOIST

[BG] Силов цилиндър за кран за повдигане на двигатели • [RO] Cilindu hidraulic pentru ridicarea motorului • [SR] Hidraulični cilindar za podizanje hidrauličnih motora • [MK] Хидрауличен цилиндер за дигалка на хидрауличен мотор • [RU] Гидравлический цилиндр для подъема двигателя • [SL] Hidravlični cilindar za dvigalo hidravličnega motorja • [EL] Υδραυλικός κύλινδρος για υδραυλικό ανυψωτικό κινητήρα • [HR] Hidraulički cilindar za dizalicu motora • [FR] Vérin hydraulique pour palan moteur • [IT] Cilindro idraulico per paranco motore • [ES] Hidraülিকা cilindro por levado de motoro • [PT] Cilindro hidráulico para talha do motor



Art.No	Capacity	gross weight	barcode
309905	1T	14.000 kg	3800972003071
309906	2T	10.000 kg	3800972003088

GASOLINE GENERATOR RD-GG08

[BG] Генератор за ток бензинов двутактов • [RO] Generator benzina • [SR] Benzinski generator • [MK] Генератор на струја • [RU] Мощность генератора • [SL] Generator moči • [EL] Ισχύ γεννήτριας • [HR] Dizalica konzolna električna • [FR] Générateur d'essence deux temps • [IT] Generatore di benzina a due tempi • [ES] Benzina generatore du batoj • [PT] Gerador a gasolina dois cursos



Art.No	gross weight	in cartoon	barcode
090106	17.000 kg	1 pcs	3800972010659

GASOLINE GENERATOR RD-GG11

[BG] Генератор за ток бензинов двутактов • [RO] Generator benzina • [SR] Benzinski generator • [MK] Генератор на струја • [RU] Мощность генератора • [SL] Generator moči • [EL] Ισχύ γεννήτριας • [HR] Dizalica konzolna električna • [FR] Générateur d'essence deux temps • [IT] Generatore di benzina a due tempi • [ES] Benzina generatore du batoj • [PT] Gerador a gasolina dois cursos



Art.No	gross weight	in cartoon	barcode
090107	17.000 kg	1 pcs	3800972023352

GASOLINE GENERATOR RD-GG10

[BG] Генератор за ток бензинов двутактов • [RO] Generator benzina • [SR] Benzinski generator • [MK] Генератор на струја • [RU] Мощность генератора • [SL] Generator moči • [EL] Ισχύ γεννήτριας • [HR] Dizalica konzolna električna • [FR] Générateur d'essence deux temps • [IT] Generatore di benzina a due tempi • [ES] Benzina generatore du batoj • [PT] Gerador a gasolina dois cursos



Art.No	gross weight	in cartoon	barcode
090105	25.000 kg	1 pcs	3800972010666

GASOLINE GENERATOR RD-GG02

[BG] Генератор за ток бензинов • [RO] Generator benzina • [SR] Benzinski generator • [MK] Генератор на струја • [RU] Мощность генератора • [SL] Generator moči • [EL] Ισχύ γεννήτριας • [HR] Dizalica konzolna električna • [FR] Générateur d'essence • [IT] Generatore di benzina • [ES] Benzina generatore • [PT] Gerador a gasolina

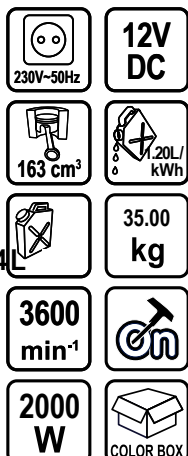

Art.No	gross weight	in cartoon	barcode
129931	39.000 kg	1 pcs	3800123145056

GASOLINE GENERATOR RD-GG06

[BG] Генератор за ток бензинов двутактов • [RO] Generator benzina • [SR] Benzinski generator • [MK] Генератор на струја • [RU] Мощность генератора • [SL] Generator moči • [EL] Ισχύ γεννήτριας • [HR] Dizalica konzolna električna • [FR] Générateur d'essence deux temps • [IT] Generatore di benzina a due tempi • [ES] Benzina generatore du batoj • [PT] Gerador a gasolina dois cursos

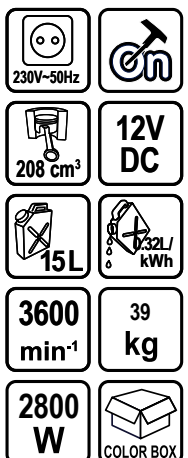

Art.No	gross weight	in cartoon	barcode
090103	44.000 kg	1 pcs	3800972000483

GASOLINE GENERATOR RD-GG03

[BG] Генератор за ток бензинов двутактов • [RO] Generator benzina • [SR] Benzinski generator • [MK] Генератор на струја • [RU] Мощность генератора • [SL] Generator moči • [EL] Ισχύ γεννήτριας • [HR] Dizalica konzolna električna • [FR] Générateur d'essence deux temps • [IT] Generatore di benzina a due tempi • [ES] Benzina generatore du batoj • [PT] Gerador a gasolina dois cursos



Art.No	gross weight	in cartoon	barcode
129941	83.000 kg	1 pcs	3800123120213

GASOLINE GENERATOR RD-GG07

[BG] Генератор за ток бензинов двуктактов • [RO] Generator benzina • [SR] Benzinski generator • [MK] Генератор на струја • [RU] Мощность генератора • [SL] Generator moči • [EL] Ισχύ γεννήτριας • [HR] Dizalica konzolna električna • [FR] Générateur d'essence deux temps • [IT] Generatore di benzina a due tempi • [ES] Benzina generador du batoj • [PT] Gerador a gasolina dois cursos

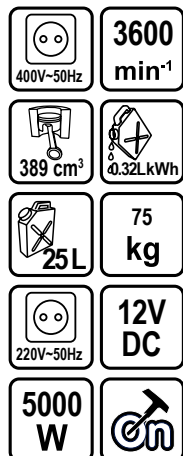

Art.No	gross weight	in cartoon	barcode
090104	84.000 kg		3800972000490

ELECTRIC CERAMIC FAN HEATER RD-EFH07

[BG] Калорифер електрически • [RO] Incalzitor electric • [SR] Električni grejač • [MK] Калорифер електрични • [RU] Электрический нагреватель • [SL] Električni grelec zraka • [EL] Ηλεκτρική θερμάστρα • [HR] Električni grijač • [FR] Aérotherme industriel électrique • [IT] Termoventilatore elettrico industriale • [ES] Elektra industria ventumilo • [PT] Aquecedor elétrico industrial

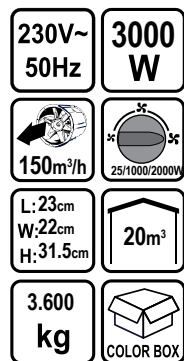

Art.No	gross weight	barcode
078807	--- kg	3800972024083

ELECTRIC CERAMIC FAN HEATER RD-EFH08

[BG] Калорифер електрически • [RO] Incalzitor electric • [SR] Električni grejač • [MK] Калорифер електрични • [RU] Электрический нагреватель • [SL] Električni grelec zraka • [EL] Ηλεκτρική θερμάστρα • [HR] Električni grijač • [FR] Aérotherme industriel électrique • [IT] Termoventilatore elettrico industriale • [ES] Elektra industria ventumilo • [PT] Aquecedor elétrico industrial

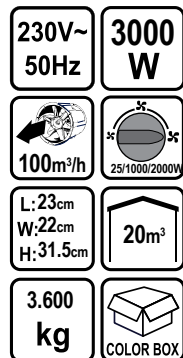

Art.No	gross weight	barcode
078808	--- kg	3800972024090

ELECTRIC INDUSTRIAL FAN HEATER RD-EFH02

[BG] Калорифер електрически • [RO] Incalzitor electric • [SR] Električni grejač • [MK] Калорифер електрични • [RU] Электрический нагреватель • [SL] Električni grelec zraka • [EL] Ηλεκτρική θερμάστρα • [HR] Električni grijač • [FR] Aérotherme industriel électrique • [IT] Termoventilatore elettrico industriale • [ES] Elektra industria ventumilo • [PT] Aquecedor elétrico industrial



Art.No	gross weight	barcode
078801	4.000 kg	3800123167874

ELECTRIC INDUSTRIAL FAN HEATER RD-EFH03

[BG] Калорифер електрически • [RO] Incalzitor electric • [SR] Električni grejač • [MK] Калорифер електрични • [RU] Электрический нагреватель • [SL] Električni grelec zraka • [EL] Ηλεκτρική θερμάστρα • [HR] Električni grijač • [FR] Aérotherme industriel électrique • [IT] Termoventilatore elettrico industriale • [ES] Elektra industria ventumilo • [PT] Aquecedor elétrico industrial



Art.No	gross weight	barcode
078806	4.900 kg	3800123167911

ELECTRIC INDUSTRIAL FAN HEATER RD-EFH3.3

[BG] Калорифер електрически • [RO] Incalzitor electric • [SR] Električni grejač • [MK] Калорифер електрични • [RU] Электрический нагреватель • [SL] Električni grelec zraka • [EL] Ηλεκτρική θερμάστρα • [HR] Električni grijač • [FR] Aérotherme industriel électrique • [IT] Termoventilatore elettrico industriale • [ES] Elektra industria ventumilo • [PT] Aquecedor elétrico industrial



Art.No	gross weight	barcode
123303	5.500 kg	3800123133886

ELECTRIC INDUSTRIAL FAN HEATER RD-EFH05

[BG] Калорифер електрически • [RO] Incalzitor electric • [SR] Električni grejač • [MK] Калорифер електрични [RU] Электрический нагреватель • [SL] Električni grelec zraka • [EL] Ηλεκτρική θερμάστρα • [HR] Električni grijač • [FR] Aérotherme industriel électrique • [IT] Termoventilatore elettrico industriale • [ES] Elektra industria ventumilo • [PT] Aquecedor elétrico industrial

400V~ 50Hz	5000 W
200m³/h	45/2500/5000W
L: 27cm W: 25.5cm H: 40cm	50m³
4.900 kg	COLOR BOX



Art.No	gross weight	barcode
078803	5.700 kg	3800123167881

ELECTRIC INDUSTRIAL FAN HEATER RD-EFH09

[BG] Калорифер електрически • [RO] Incalzitor electric • [SR] Električni grejač • [MK] Калорифер електрични [RU] Электрический нагреватель • [SL] Električni grelec zraka • [EL] Ηλεκτρική θερμάστρα • [HR] Električni grijač • [FR] Aérotherme industriel électrique • [IT] Termoventilatore elettrico industriale • [ES] Elektra industria ventumilo • [PT] Aquecedor elétrico industrial

400V~ 50Hz	9000 W
300m³/h	55/4500/9000W
L: 35cm W: 35cm H: 50.5cm	80m³
9.500 kg	COLOR BOX



Art.No	gross weight	barcode
078804	10.400 kg	3800123167898

ELECTRIC INDUSTRIAL FAN HEATER RD-EFH15

[BG] Калорифер електрически • [RO] Incalzitor electric • [SR] Električni grejač • [MK] Калорифер електрични [RU] Электрический нагреватель • [SL] Električni grelec zraka • [EL] Ηλεκτρική θερμάστρα • [HR] Električni grijač • [FR] Aérotherme industriel électrique • [IT] Termoventilatore elettrico industriale • [ES] Elektra industria ventumilo • [PT] Aquecedor elétrico industrial

400V~ 50Hz	15000 W
400m³/h	65/7500/15000W
L: 46cm W: 39cm H: 59cm	120m³
16.400 kg	COLOR BOX



Art.No	gross weight	barcode
078805	17.400 kg	3800123167904

PANEL HEATER 2KW WHITE RD-PH01

[BG] Конвектор със стойка • [RO] Incalzitor electric • [SR] Električni grejač • [MK] Калорифер електрични [RU] Электрический нагреватель • [SL] Električni grelec zraka • [EL] Ηλεκτρική θερμάστρα • [HR] Električni grijač • [FR] Aérotherme industriel électrique • [IT] Termoventilatore elettrico industriale • [ES] Elektra industria ventumilo • [PT] Aquecedor elétrico industrial

2000
W



Art.No	gross weight	barcode
078809	17.400 kg	3800972027978

PANEL HEATER 2KW WHITE GLASS LED RD-PH02

[BG] Конвектор със стойка • [RO] Incalzitor electric • [SR] Električni grejač • [MK] Калорифер електрични [RU] Электрический нагреватель • [SL] Električni grelec zraka • [EL] Ηλεκτρική θερμάστρα • [HR] Električni grijač • [FR] Aérotherme industriel électrique • [IT] Termoventilatore elettrico industriale • [ES] Elektra industria ventumilo • [PT] Aquecedor elétrico industrial

2000
W



Art.No	gross weight	barcode
078810	17.400 kg	3800972027985

PANEL HEATER 2KW BLACK GLASS LED RD-PH03

[BG] Конвектор със стойка • [RO] Incalzitor electric • [SR] Električni grejač • [MK] Калорифер електрични [RU] Электрический нагреватель • [SL] Električni grelec zraka • [EL] Ηλεκτρική θερμάστρα • [HR] Električni grijač • [FR] Aérotherme industriel électrique • [IT] Termoventilatore elettrico industriale • [ES] Elektra industria ventumilo • [PT] Aquecedor elétrico industrial

2000
W



Art.No	gross weight	barcode
078811	17.400 kg	3800972027992

PANEL HEATER 2KW BLACK GLASS LED WI-FI RD-PH04

[BG] Конвектор със стойка • [RO] Incalzitor electric • [SR] Električni grejač • [MK] Калорифер електрични [RU] Электрический нагреватель • [SL] Električni grelec zraka • [EL] Ηλεκτρική θερμάστρα • [HR] Električni grijač • [FR] Aérotherme industriel électrique • [IT] Termoventilatore elettrico industriale • [ES] Elektra industria ventumilo • [PT] Aquecedor elétrico industrial

2000
W



Art.No	gross weight	barcode
078812	17.400 kg	3800972028005

GAS HEATER RD-GH 15

[BG] Калорифер на газ • [RO] Aeroterma • [SR] Grejač gasni • [MK] Калорифер на гас • [RU] Подогреватель газа пропана • [SL] Plinov Grelnik • [EL] Θερμάστρα αερίου • [HR] Plinski grijač • [FR] Chauffage à gaz • [IT] Stufa a gas • [ES] Gas-hejtilo • [PT] Aquecedor a gas



230V~ 50Hz	15000 W
300m ³ /h	116m ³
L: 47.3cm W: 20.7cm H: 32.2cm	4.600 kg
	COLOR BOX

Art.No	gross weight	barcode
129973	5.200 kg	3800123101809

GAS HEATER RD-GH40

[BG] Калорифер на газ • [RO] Aeroterma • [SR] Grejač gasni • [MK] Калорифер на гас • [RU] Подогреватель газа пропана • [SL] Plinov Grelnik • [EL] Θερμάστρα αερίου • [HR] Plinski grijač • [FR] Chauffage à gaz • [IT] Stufa a gas • [ES] Gas-hejtilo • [PT] Aquecedor a gas



230V~ 50Hz	40000 W
750m ³ /h	310m ³
L: 57.2cm W: 22.5cm H: 37.4cm	6.400 kg
	COLOR BOX

Art.No	gross weight	barcode
450201	7.100 kg	3800123167928

DIESEL SPACE HEATER RD-DSH50

[BG] Калорифер нафтов • [RO] Generator aer cald ardere directa diesel • [SR] Grejač Nafta • [MK] Калорифер нафтов • [RU] Тепловая пушка • [SL] Premični grelnik zraka • [EL] Αεροθερμιο Πετρελαιοιου • [HR] Dizelski grijač • [FR] Chauffage spatial diesel • [IT] Riscaldatore di spazio diesel • [ES] Diesel a hejtilo • [PT] Aquecedor a diesel



230V~ 50Hz	50 kW
800m ³ /h	400m ³
L: 110cm W: 48cm H: 50cm	28.900 kg
	COLOR BOX

Art.No	gross weight	barcode
123304	31.500 kg	3800123133893

FAN 30CM 3 SPEED LEVELS INOX RD-F1

[BG] Вентилатор • [RO] Ventilator • [SR] Lepeza • [MK] Вентилатор [RU] Вентилятор • [SL] Ventilator • [EL] Ανεμιστήρας • [HR] Ανεμιστήρας • [FR] Ventilateur • [IT] Fan • [ES] Admirador • [PT] Fã

40
W



Art.No	gross weight	barcode
078901	-- kg	3800972026698

FAN 50CM 3 SPEED LEVELS INOX RD-F2

[BG] Вентилатор • [RO] Ventilator • [SR] Lepeza • [MK] Вентилатор [RU] Вентилятор • [SL] Ventilator • [EL] Ανεμιστήρας • [HR] Ανεμιστήρας • [FR] Ventilateur • [IT] Fan • [ES] Admirador • [PT] Fã

120
W



Art.No	gross weight	barcode
078902	-- kg	3800972026704



ELECTRIC CHAIN SAW RD-ECS21

[BG] Резачка електрическа • [RO] Fierastrau electric cu lant • [SR] Električna motorna testera
 • [MK] Електрична пила • [RU] Электрические цепные пилы • [SL] Električna žaga
 • [EL] Ηλεκτρικό αλυσοπρίονο • [HR] Električna lančana pila • [FR] Scie à chaîne électrique
 • [IT] Sega a catena elettrica • [ES] Elektra segilo • [PT] Moto-serra elétrica



Art.No	gross weight	in cartoon	barcode
075115	5.480 kg	2 pcs	3800972015418

ELECTRIC CHAIN SAW RD-ECS16X

[BG] Резачка електрическа • [RO] Fierastrau electric cu lant • [SR] Električna motorna testera
 • [MK] Електрична пила • [RU] Электрические цепные пилы • [SL] Električna žaga
 • [EL] Ηλεκτρικό αλυσοπρίονο • [HR] Električna lančana pila • [FR] Scie à chaîne électrique
 • [IT] Sega a catena elettrica • [ES] Elektra segilo • [PT] Moto-serra elétrica



Art.No	gross weight	in cartoon	barcode
075110	4.990 kg	2 pcs	3800972002272

ELECTRIC CHAIN SAW RD-ECS22

[BG] Резачка електрическа • [RO] Fierastrau electric cu lant • [SR] Električna motorna testera
 • [MK] Електрична пила • [RU] Электрические цепные пилы • [SL] Električna žaga
 • [EL] Ηλεκτρικό αλυσοπρίονο • [HR] Električna lančana pila • [FR] Scie à chaîne électrique
 • [IT] Sega a catena elettrica • [ES] Elektra segilo • [PT] Moto-serra elétrica



Art.No	gross weight	in cartoon	barcode
075116	5.600 kg	2 pcs	3800972015425

ELECTRIC CHAIN SAW RD-ECS23

[BG] Резачка електрическа • [RO] Fierastrau electric cu lant • [SR] Električna motorna testera
 • [MK] Електрична пила • [RU] Электрические цепные пилы • [SL] Električna žaga
 • [EL] Ηλεκτρικό αλυσοπρίονο • [HR] Električna lančana pila • [FR] Scie à chaîne électrique
 • [IT] Sega a catena elettrica • [ES] Elektra segilo • [PT] Moto-serra elétrica

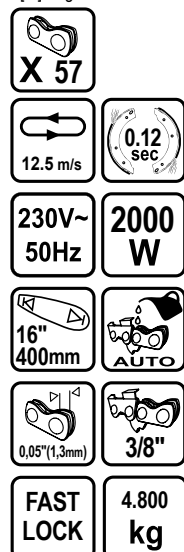

Art.No	gross weight	in cartoon	barcode
075117	5.270 kg	2 pcs	3800972015432

ELECTRIC CHAIN SAW RD-ECS17X

[BG] Резачка електрическа • [RO] Fierastrau electric cu lant • [SR] Električna motorna testera
 • [MK] Електрична пила • [RU] Электрические цепные пилы • [SL] Električna žaga
 • [EL] Ηλεκτρικό αλυσοπίρινο • [HR] Električna lančana pila • [FR] Scie à chaîne électrique
 • [IT] Sega a catena elettrica • [ES] Elektra segilo • [PT] Moto-serra elétrica

230V~ 50Hz	2000 W
16" 400mm	AUTO
0,05"(1,3mm)	3/8"
12.5 m/s	FAST LOCK
0.12 sec	4.920 kg
X 57	COLOR BOX



Art.No	gross weight	in cartoon	barcode
075111	5.270 kg	2 pcs	3800972002289

ELECTRIC CHAIN SAW RD-ECS18X

[BG] Резачка електрическа • [RO] Fierastrau electric cu lant • [SR] Električna motorna testera
 • [MK] Електрична пила • [RU] Электрические цепные пилы • [SL] Električna žaga
 • [EL] Ηλεκτρικό αλυσοπίρινο • [HR] Električna lančana pila • [FR] Scie à chaîne électrique
 • [IT] Sega a catena elettrica • [ES] Elektra segilo • [PT] Moto-serra elétrica

230V~ 50Hz	2200 W
16" 400mm	AUTO
0,05"(1,3mm)	3/8"
12.5 m/s	FAST LOCK
0.12 sec	5.420 kg
X 57	COLOR BOX



Art.No	gross weight	in cartoon	barcode
075112	5.750 kg	2 pcs	3800972002296

ELECTRIC CHAIN SAW RD-ECS20X

[BG] Резачка електрическа • [RO] Fierastrau electric cu lant • [SR] Električna motorna testera
 • [MK] Електрична пила • [RU] Электрические цепные пилы • [SL] Električna žaga
 • [EL] Ηλεκτρικό αλυσοπίρινο • [HR] Električna lančana pila • [FR] Scie à chaîne électrique
 • [IT] Sega a catena elettrica • [ES] Elektra segilo • [PT] Moto-serra elétrica

230V~ 50Hz	12.5 m/s
16" 400mm	0.12 sec
0,05"(1,3mm)	X 57
2400 W	FAST LOCK
AUTO	3/8"
4.800 kg	COLOR BOX



Art.No	gross weight	in cartoon	barcode
075114	5.750 kg	2 pcs	3800972014299

ELECTRIC CHAIN SAW RD-ECS25

[BG] Резачка електрическа • [RO] Fierastrau electric cu lant • [SR] Električna motorna testera
 • [MK] Електрична пила • [RU] Электрические цепные пилы • [SL] Električna žaga
 • [EL] Ηλεκτρικό αλυσοπίρινο • [HR] Električna lančana pila • [FR] Scie à chaîne électrique
 • [IT] Sega a catena elettrica • [ES] Elektra segilo • [PT] Moto-serra elétrica

230V~ 50Hz	3/8"
18" 450mm	12.5 m/s
0,05"(1,3mm)	0.12 sec
2400 W	X 62
AUTO	FAST LOCK
5.550 kg	COLOR BOX



Art.No	gross weight	in cartoon	barcode
075119	6.300 kg	2 pcs	3800972015456

ELECTRIC CHAIN SAW RDP-ECS27

[BG] Резачка електрическа • [RO] Fierastrau electric cu lant • [SR] Električna motorna testera
 • [MK] Електрична пила • [RU] Электрические цепные пилы • [SL] Električna žaga
 • [EL] Ηλεκτρικό αλυσοπίρινο • [HR] Električna lančana pila • [FR] Scie à chaîne électrique
 • [IT] Sega a catena elettrica • [ES] Elektra segilo • [PT] Moto-serra elétrica

230V~ 50Hz	3/8"
18" 450mm	12.5 m/s
0,05"(1,3mm)	0.12 sec
2400 W	X 62
AUTO	FAST LOCK
5.550 kg	COLOR BOX



Art.No	gross weight	in cartoon	barcode
075120	6.300 kg	2 pcs	3800972024496

RAIDER[®]
Pro



GASOLINE CHAIN SAW RDP-GCS18

[BG] Резачка бензинова • [RO] Motofierastrau benzina cu lant • [SR] Benzinska lancana testera • [MK] Моторна пила • [RU] Цепная пила газолина • [SL] Motornih žag • [EL] Βενζινοκίνητο Αλυσοπρίοιο • [HR] Motorna pila • [FR] Scie à chaîne essence • [IT] Motosega a benzina • [ES] Gasoline čeno vidis • [PT] Moto-serra a gasolin

	900 W	3 200 min⁻¹	
	0.12 sec		
FUEL / OIL 25:1	X 64		
	4.400 kg		



art. №	gross weight	in cartoon	barcode
075109	5.040 kg	2 pcs	3800123174087

GASOLINE CHAIN SAW RD-GCS24

[BG] Резачка бензинова • [RO] Motofierastrau benzina cu lant • [SR] Benzinska lancana testera • [MK] Моторна пила • [RU] Цепная пила газолина • [SL] Motornih žag • [EL] Βενζινοκίνητο Αλυσοπρίοιο • [HR] Motorna pila • [FR] Scie à chaîne essence • [IT] Motosega a benzina • [ES] Gasoline čeno vidis • [PT] Moto-serra a gasolin

	1800 W	6.500 kg	
	0.12 sec		
3 200 min⁻¹	FUEL / OIL 25:1		



art. №	gross weight	in cartoon	BARCODE
076706	7.040 kg	2 pcs	3800972019423

GASOLINE CHAIN SAW RD-GCS31

[BG] Резачка бензинова • [RO] Motofierastrau benzina cu lant • [SR] Benzinska lancana testera • [MK] Моторна пила • [RU] Цепная пила газолина • [SL] Motornih žag • [EL] Βενζινοκίνητο Αλυσοπρίοιο • [HR] Motorna pila • [FR] Scie à chaîne essence • [IT] Motosega a benzina • [ES] Gasoline čeno vidis • [PT] Moto-serra a gasolin

	2200 W	6.500 kg	
	0.12 sec		
3 200 min⁻¹	FUEL / OIL 25:1		



art. №	gross weight	in cartoon	barcode
076712	7.040 kg	2 pcs	3800972026612

GASOLINE CHAIN SAW RD-GCS30

[BG] Резачка бензинова • [RO] Motofierastrau benzina cu lant • [SR] Benzinska lancana testera • [MK] Моторна пила • [RU] Цепная пила газолина • [SL] Motornih žag • [EL] Βενζινοκίνητο Αλυσοπρίοιο • [HR] Motorna pila • [FR] Scie à chaîne essence • [IT] Motosega a benzina • [ES] Gasoline čeno vidis • [PT] Moto-serra a gasolin

	2400 W	6.500 kg	
	0.12 sec		
3 200 min⁻¹	FUEL / OIL 25:1		



art. №	gross weight	in cartoon	barcode
076711	7.040 kg	2 pcs	3800972026247

GASOLINE CHAIN SAW RD-GCS13

[BG] Резачка бензинова • [RO] Motofierastrau benzina cu lant • [SR] Benzinska lancana testera • [MK] Моторна пила • [RU] Цепная пила газолина • [SL] Motornih žag • [EL] Βενζινοκίνητο Αλυσοπρίοιο • [HR] Motorna pila • [FR] Scie à chaîne essence • [IT] Motosega a benzina • [ES] Gasoline čeno vidis • [PT] Moto-serra a gasolin

	3 200 min⁻¹		
	6.500 kg		
1800 W	FUEL / OIL 25:1		



art. №	gross weight	in cartoon	BARCODE
075104	7.040 kg	2 pcs	3800123169847

GASOLINE CHAIN SAW

[BG] Резачка бензинова • [RO] Motofierastrau benzina cu lant • [SR] Benzinska lancana testera • [MK] Моторна пила • [RU] Цепная пила газолина • [SL] Motornih žag • [EL] Βενζινοκίνητο Αλυσοπρίοιο • [HR] Motorna pila • [FR] Scie à chaîne essence • [IT] Motosega a benzina • [ES] Gasoline čeno vidis • [PT] Moto-serra a gasolin

FUEL / OIL 25:1			
3 200 min⁻¹			
		5.900 kg	



art. №	W	gross weight	in cartoon	BARCODE
075105 RD-GCS14	2000	6.500 kg	2 pcs	3800123169885
075106 RD-GCS15	2200	6.500 kg	2 pcs	3800123169892

GASOLINE CHAIN SAW

[BG] Резачка бензинова • [RO] Motofierastru benzina cu lant • [SR] Benzinska lancana testera • [MK] Моторна пила • [RU] Цепная пила газелина • [SL] Motornih žag • [EL] Βενζινοκίνητο Αλυσοπρίοно • [HR] Motorna pila • [FR] Scie à chaîne essence • [IT] Motosega a benzina • [ES] Gasoline čeno vidis • [PT] Moto-serra a gasolin

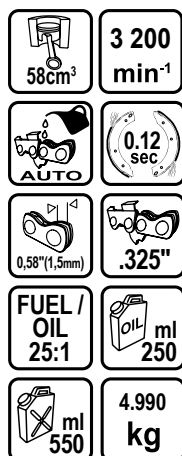

art. №	in cartoon	BARCODE
076701 RD-GCS19	2 pcs	3800972004177
076702 RD-GCS20	2 pcs	3800972004184

GASOLINE CHAIN SAW RDP-GCS07

[BG] Резачка бензинова • [RO] Motofierastru benzina cu lant • [SR] Benzinska lancana testera • [MK] Моторна пила • [RU] Цепная пила газелина • [SL] Motornih žag • [EL] Βενζινοκίνητο Αλυσοπρίοно • [HR] Motorna pila • [FR] Scie à chaîne essence • [IT] Motosega a benzina • [ES] Gasoline čeno vidis • [PT] Moto-serra a gasolin



RAIDER[®]
Pro

EasyOn

Art.No	gross weight	in cartoon	barcode
129993	8.500 kg	2 pcs	3800123133435

GASOLINE CHAIN SAW RDP-GCS08

[BG] Резачка бензинова • [RO] Motofierastru benzina cu lant • [SR] Benzinska lancana testera • [MK] Моторна пила • [RU] Цепная пила газелина • [SL] Motornih žag • [EL] Βενζινοκίνητο Αλυσοπρίοно • [HR] Motorna pila • [FR] Scie à chaîne essence • [IT] Motosega a benzina • [ES] Gasoline čeno vidis • [PT] Moto-serra a gasolin



RAIDER[®]
Pro

Art.No	gross weight	in cartoon	barcode
129994	8.000 kg	2 pcs	3800123133442

GASOLINE CHAIN SAW RDP-GCS25

[BG] Резачка бензинова • [RO] Motofierastru benzina cu lant • [SR] Benzinska lancana testera • [MK] Моторна пила • [RU] Цепная пила газелина • [SL] Motornih žag • [EL] Βενζινοκίνητο Αλυσοπρίοно • [HR] Motorna pila • [FR] Scie à chaîne essence • [IT] Motosega a benzina • [ES] Gasoline čeno vidis • [PT] Moto-serra a gasolin

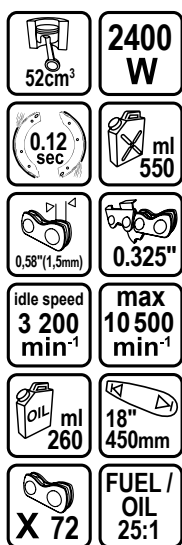

RAIDER[®]
Pro

EasyOn

Art.No	gross weight	in cartoon	barcode
076707	7.350 kg	2 pcs	3800972019218

AIR FILTER FOR RDP-GCS25 & 26

[BG] Филтър въздушен • [RO] Filtru de aer • [SR] Vazdušni filter • [MK] Воздушен филтер • [RU] Воздушный фильтр • [SL] Zračni filter • [EL] Φίλτρο αέρα • [HR] Zračni filter • [FR] Filtre à air • [IT] Filtro dell'aria • [ES] Filtro de aire • [PT] Filtro de ar



Art.No	barcode
140125	3800972019706



GASOLINE CHAIN SAW RDP-GCS26

[BG] Ресачка бензинова • [RO] Motofierastrau benzina cu lant • [SR] Benzinska lancana testera • [MK] Моторна пила • [RU] Цепная пила газолина • [SL] Motornih žag • [EL] Βενζινοκίνητο Αλυσοπίριο • [HR] Motorna pila • [FR] Scie à chaîne essence • [IT] Motosega a benzina • [ES] Gasoline čeno vidis • [PT] Moto-serra a gasolin

 52cm ³	2400 W
 0.12 sec	 ml 550
 0.58"(1.5mm)	 0.325"
 idle speed 3 200 min ⁻¹	 max 10 500 min ⁻¹
 ml 260	 18" 450mm
 X 72	 FUEL / OIL 25:1



RAIDER® Pro
EasyOn

Art.No	gross weight	in cartoon	barcode
076708	--- kg	2 pcs	3800972024236

GASOLINE CHAIN SAW RDP-GCS23

[BG] Ресачка бензинова • [RO] Motofierastrau benzina cu lant • [SR] Benzinska lancana testera • [MK] Моторна пила • [RU] Цепная пила газолина • [SL] Motornih žag • [EL] Βενζινοκίνητο Αλυσοπίριο • [HR] Motorna pila • [FR] Scie à chaîne essence • [IT] Motosega a benzina • [ES] Gasoline čeno vidis • [PT] Moto-serra a gasolin

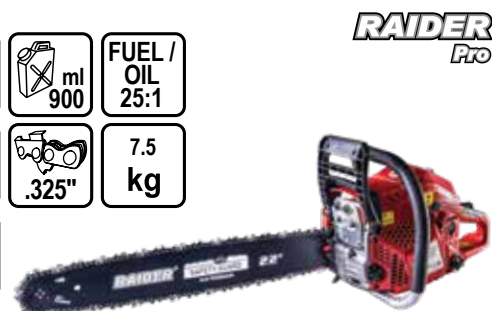
 58cm ³	3 200 min⁻¹	 ml 900	 FUEL / OIL 25:1
 0.12 sec	 ml 250	 .325"	 7.5 kg
 0.58"(1.5mm)	 X 84		
 2800 W	 22" 560mm		

RAIDER® Pro
EasyOn

Art.No	gross weight	in cartoon	barcode
076705	8.000 kg	2 pcs	3800972015487

SAFETY HELMET WITH EARMUFFS AND STEEL MESH

[BG] Каска с антифони • [RO] Casca de protectie cu casti pentru urechi • [SR] Zaštitni šlem sa štitnicima za uši • [MK] Заштитна кацига со заштитни уши • [RU] Защитный шлем с наушниками • [SL] Zaščitna čelada z glušniki • [EL] Κράνος ασφαλείας με ωτοασπίδες • [HR] Zaštitna kaciga sa štitnicima za uši • [FR] Casque de sécurité avec cache-oreilles • [IT] Casco di sicurezza con cuffie • [ES] Casco de seguridad con orejeras • [PT] Capacete de segurança com protetores de ouvido



Art.No	gross weight	in cartoon	barcode
561301	-- kg	2 pcs	3800972016163

CARRY BAG FOR CHAINSAWS RAIDER





[BG] Чанта за верижни триони • [RO] Casca de protectie cu casti pentru urechi • [SR] Zaštitni šlem sa štitnicima za uši • [MK] Заштитна кацига со заштитни уши • [RU] Сумка для цепной пилы • [SL] Zaščitna čelada z glušniki • [EL] Κράνος ασφαλείας με ωτοασπίδες • [HR] Zaštitna kaciga sa štitnicima za uši • [FR] Casque de sécurité avec cache-oreilles • [IT] Casco di sicurezza con cuffie • [ES] Casco de seguridad con orejeras • [PT] Capacete de segurança com protetores de ouvido



Art.No	gross weight	in cartoon	barcode
549885	-- kg	2 pcs	3800972025721

ELECTRIC CHAIN SAW SHARPENER RD-CSS01

[BG] Машина за точене на вериги • [RO] Aparat de ascutire lant drijba • [SR] Mašina za oštrenje lanca motorke • [MK] Машина за острене за ланец • [RU] Станки для заточки цепей • [SL] Brusilni stroj za brušenje verig • [EL] Τροχιστής αλυσίδας αλυσοπίριου • [HR] Stroj za oštrenje lanaca • [FR] Aiguiseur de tronçonneuse électrique • [IT] Affilacoltelli elettrico • [ES] Elektra mastruma motilo • [PT] Apontador de motosserra elétrica

230V~ 50Hz	220 W	3200 min⁻¹
 100 mm	 10 mm	 0-35°
2.500 kg	 COLOR BOX	

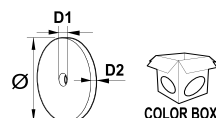

Art.No	gross weight	in cartoon	barcode
140108	2.620 kg	4 pcs	3800123163210

DISC FOR CHAIN SAW SHARPENER

art. №	Ø (mm)	D1 (mm)	D2 (mm)	BARCODE
140109	100	10	3.2	3800123163227

SAW CHAIN SHARPENER RD



Art.No	gross weight	in cartoon	barcode
075121	-- kg	-- pcs	3800972025349

SHARPENING STONE 4 PCS. FOR SAW CHAIN SHARPENER RD



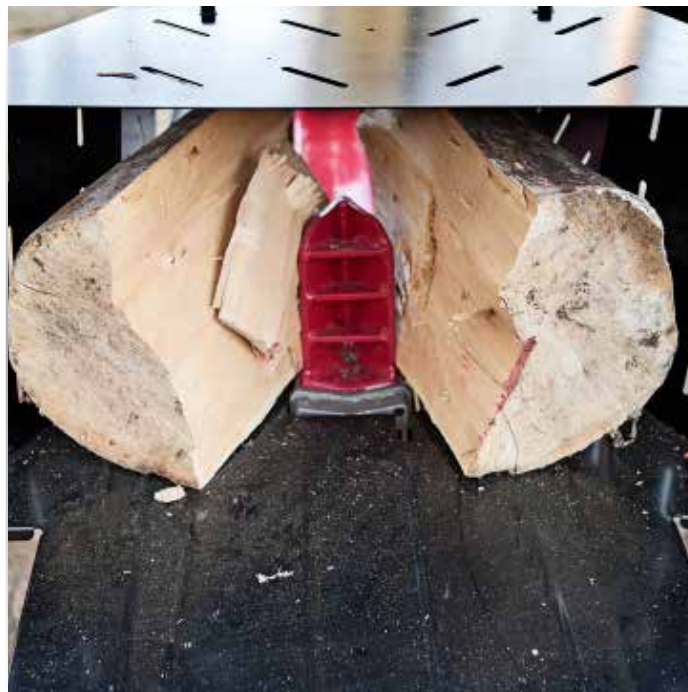

Art.No	gross weight	in cartoon	barcode
075122	-- kg	4 pcs	3800972025356



FILE FILING GUIDE KIT FOR CHAIN SAW

[BG] Пила с водач комплект за верижен трион • [RO] Kit ascutire lant • [SR] Turpija za lančanu testeru sa vodič set • [MK] Турпија за ланец за моторна пила со водич • [RU] Набор для заточки цепей - напильник и шаблон



art. №			barcode
140112 for electric chain saw	3/8"	4mm	3800123167430
140113 for gasoline chain saw	.325"	4.8mm	3800123167447

GREASE GUN WITH GREASE FOR CHAIN SAW

[BG] Такаламит с грес за верижен трион • [RO] Pistol gresare pentru fierastrau cu lant • [SR] Mazalica sa mast za motorna testera • [MK] Мазалица рачна декаламитна за моторна пила • [RU] Шприц для смазки для цепные пилы



Art.No	barcode
141304	3800123167423

POLISHING GALVANIZED LOG SAW TRESTLE





[BG] Стойка за рязане на дърва • [RO] Suport capra pentru taiat lemne • [SR] Metalni stalak za piljenje • [MK] Држач за сечење на дрва • [RU] Подставка для резания древесины • [SL] Koza za žaganje drv • [EL] Καβαλέτο Κοπής Ξύλων • [HR] Metalni stalak za piljenje • [FR] Tréteau de scie à grumes galvanisé • [IT] Tronchetto per seghe a filo zincato lucidato • [ES] Poluranta galvanan ensaluton rigardis • [PT] Cavalete de serra galvanizado de polimento



Art.No	barcode
140118	3800123174704

LOG SPLITTER RD-LGS01T

[BG] Машина за целене на дърва • [RO] Dispozitiv pentru despicat busteni • [SR] Сераџ за дрва • [MK] Цепач на дрва • [RU] Машина для колки дров • [SL] Cepilec drv • [EL] Τεμαχιστής Ξύλων (Τριφασικός) • [HR] Stroj za cijerpanje drva • [FR] Machine à couper le bois • [IT] Trinciatrice del legno • [ES] Tajpado de ligno • [PT] Rachador de lenha





230V~ 50Hz	 L 2.2
 300mm	2 950 min ⁻¹
 52 cm	5 - 25 ∅ cm
1500 W	33.3 kg
 4 tons	 COLOR BOX



Art.No	gross weight	in cartoon	barcode
129939	37.0 kg	1	3800123123009

LOG SPLITTER 520MM 5T RD-LGS02

[BG] Машина за целене на дърва • [RO] Dispozitiv pentru despicat busteni • [SR] Сераџ за дрва • [MK] Цепач на дрва • [RU] Машина для колки дров • [SL] Cepilec drv • [EL] Τεμαχιστής Ξύλων (Τριφασικός) • [HR] Stroj za cijerpanje drva • [FR] Machine à couper le bois • [IT] Trinciatrice del legno • [ES] Tajpado de ligno • [PT] Rachador de lenha



230V~ 50Hz	 L 2.2
 300mm	2 950 min ⁻¹
 52 cm	5 - 25 ∅ cm
1500 W	54.3 kg
 5 tons	 COLOR BOX



Art.No	gross weight	in cartoon	barcode
060001	57.0 kg	1	3800972020115

SAW CHAIN FOR GASOLINE CHAIN SAW



[BG] Верига за резачка • [RO] Lant pentru ferestrau • [SR] Lanac za lančanu testeru
 • [MK] Ланец за моторна пила • [RU] Цепь пила • [SL] Veriga za žago • [EL] Αλυσίδα
 • [HR] Lanac za pila • [FR] Chaîne de scie • [IT] Ha visto la catena • [ES] Vidita Čeno
 • [PT] Corrente de serra

art. №				BARCODE
140116 for RDGCS18	3/8"	.050" (1.3mm)	45	3800123174513
140117 for RD-GCS18	3/8"	.050" (1.3mm)	40	3800123174650
140120 for RD-GCS22	.325"	.058" (1.5mm)	60	3800972014343
140105	.325"	.050" (1.3mm)	64	3800123162381
140119 RD-GCS13&14	.325"	.058" (1.5mm)	64	3800972004153
140106	.325"	.050" (1.3mm)	72	3800123162398
140107 for RD-GCS15, 19, 20, 07, 08, 21	.325"	.058" (1.5mm)	72	3800123162404
140122 for RDP-GCS23	.325"	.058" (1.5mm)	84	3800972015593

SAW CHAIN FOR GASOLINE CHAIN SAW

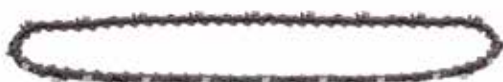

[BG] Верига за резачка • [RO] Lant pentru ferestrau • [SR] Lanac za lančanu testeru
 • [MK] Ланец за моторна пила • [RU] Цепь пила • [SL] Veriga za žago • [EL] Αλυσίδα
 • [HR] Lanac za pila • [FR] Chaîne de scie • [IT] Ha visto la catena • [ES] Vidita Čeno
 • [PT] Corrente de serra



art. №				BARCODE
140123 for RD-GCS15, 19, 20, 07, 08, 21 и 25 Promo	.325"	.058" (1.5mm)	72	3800972018006
140121 for RD-ECS25	3/8"	.050" (1.3mm)	62	3800972015586
140124 for RD-ECS	3/8"	.050" (1.3mm)	57	3800972018013

GUIDE BAR



[BG] Водач за верига за резачка • [RO] Lama ghidaj pentru drujba • [SR] Vodič lanca za motornu pilu • [MK] Водич за ланец за моторна пила • [RU] Направляющая шина для цепь бензопилы
 • [SL] Meč za veriga za motorno žago • [EL] Λαμα για αλυσοπιριονα • [HR] Vodičica za lanac • [FR] Barre guide • [IT] Barra guida • [ES] Gvidilo trinkejo • [PT] Barra guia

art. №				BARCODE
141301 for RD-ECS17X	16" 400mm	3.8"	0.050"(1.3mm)	57 3800123162718
141312 for RD-ECS25	18" 450mm	3.8"	0.050"(1.3mm)	62 3800972015609
141309 for RD-GCS13, 14	16" 400mm	0.325"	0.058"(1.5mm)	64 3800972002333
139964 for RD-GCS15, 19, 20, 07, 08, 21	18" 450mm	0.325"	0.058"(1.5mm)	72 3800123139956
141313 for RD-GCS23	22" 550mm	0.325"	0.058"(1.5mm)	84 3800972015616

SAW CHAIN FOR ELECTRIC CHAIN SAW

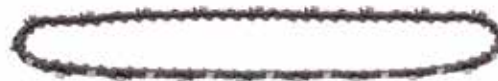
[BG] Верига за резачка • [RO] Lant pentru ferestrau • [SR] Lanac za lančanu testeru
 • [MK] Ланец за моторна пила • [RU] Цепь пила • [SL] Veriga za žago • [EL] Αλυσίδα
 • [HR] Lanac za pila • [FR] Chaîne de scie • [IT] Ha visto la catena • [ES] Vidita Čeno
 • [PT] Corrente de serra





art. №				BARCODE
140101	3/8"	.050" (1.3mm)	50	3800123162343
140102 for RD-ECS16X, SBCS20	3/8"	.050" (1.3mm)	52	3800123162350
140103	3/8"	.050" (1.3mm)	56	3800123162367
140104 for RD-ECS17X, 18X, 19, 20, 12	3/8"	.050" (1.3mm)	57	3800123162374

GUIDE BAR

[BG] Водач за верига за резачка • [RO] Lama ghidaj pentru drujba • [SR] Vodič lanca za motornu pilu • [MK] Водич за ланец за моторна пила • [RU] Направляющая шина для цепь бензопилы
 • [SL] Meč za veriga za motorno žago • [EL] Λαμα για αλυσοπιριονα • [HR] Vodičica za lanac • [FR] Barre guide • [IT] Barra guida • [ES] Gvidilo trinkejo • [PT] Barra guia





art. №				BARCODE
141306 for RD-GCS18	12" 305mm	0.050"(1.3mm)	45	3800123174551
141308 for RD-GCS18	10" 255mm	3.8"	0.050"(1.3mm)	40 3800123174643
141307 for RD-ECS14	14" 355mm	3.8"	0.050"(1.3mm)	52 3800123174568
141311 for RD-GCS22	14" 355mm	0.325"	0.058"(1.5mm)	52 3800972014350

GUIDE BAR

[BG] Водач за верига за резачка • [RO] Lama ghidaj pentru drujba • [SR] Vodič lanca za motornu pilu • [MK] Водич за ланец за моторна пила • [RU] Направляющая шина для цепь бензопилы
 • [SL] Meč za veriga za motorno žago • [EL] Λαμα για αλυσοπιριονα • [HR] Vodičica za lanac • [FR] Barre guide • [IT] Barra guida • [ES] Gvidilo trinkejo • [PT] Barra guia



GUIDE BAR OREGON

art. №				BARCODE
141314 for RDP-SBCS20	14" 350mm	3/8"	0.050"(1.3mm)	52 3800972015647
141305 for RD-EC- S18X, 19, 20	16" 400mm	3/8"	0.050"(1.3mm)	57 3800123174506

ELECTRIC BLOWER AND SHREDDER RD-EBV03

[BG] Листосъбирач • [RO] Sufianta / aspirator • [SR] Usisač lišća • [MK] Всмукувач за лисја
• [RU] Пылесос для листьев • [SL] Sesalnik za listje • [EL] Μηχανής αναρρόφησης φύλλων
• [HR] Električni Usisavač / Puhalo Lišća • [FR] Aspirateur à feuilles • [IT] Aspirapolvere a foglia
• [ES] Folia polvosuçilo • [PT] Soprador/aspirador elétrico

230V~ 50Hz	2600 W
SPEED 270 km/h	9000- 14000 min ⁻¹
13.2 m ³ /min	LEAVES BAG 35 L
3.400 kg	COLOR BOX



STRAP



Art.No	gross weight	in cartoon	barcode
075522	3.800 kg		3800972002074

ELECTRIC BLOWER AND SHREDDER RD-EBV04

[BG] Листосъбирач • [RO] Sufianta / aspirator • [SR] Usisač lišća • [MK] Всмукувач за лисја
• [RU] Пылесос для листьев • [SL] Sesalnik za listje • [EL] Μηχανής αναρρόφησης φύλλων
• [HR] Električni Usisavač / Puhalo Lišća • [FR] Aspirateur à feuilles • [IT] Aspirapolvere a foglia
• [ES] Folia polvosuçilo • [PT] Soprador/aspirador elétrico

230V~ 50Hz	3000 W
SPEED 270 km/h	9000- 15000 min ⁻¹
13.2 m ³ /min	LEAVES BAG 35 L
4.3 kg	COLOR BOX



STRAP

Art.No	gross weight	in cartoon	barcode
075529	5.300 kg	4 pcs	3800972002050

GASOLINE BLOWER AND VACUUM RD-GBV05

[BG] Листосъбирач бензинов • [RO] Sufianta / aspirator pentru benzină • [SR] Usisač lišća benzina
• [MK] Метла за лисја бензина • [RU] Воздуходувка • [SL] Sesalnik za listje
• [EL] Μηχανής αναρρόφησης φύλλων • [HR] Električni Usisavač / Puhalo Lišća • [FR] Aspirateur à essence • [IT] Aspirapolvere a benzina • [ES] Gasolina blivilo malplena • [PT] Soprador a gasolina

750 W	6500 min ⁻¹
SPEED 130 ml/s	13.2 m ³ /min
FUEL / OIL 25:1	ml 650
LEAVES BAG 30 L	4.700 kg
COLOR BOX	



STRAP



Art.No	gross weight	barcode
077401	5.200 kg	3800972003712

GASOLINE BACKPACK BLOWER RD-GBV06

[BG] Моторна метла • [RO] Aspirator/sufianta pe benzină • [SR] benzinski ranac puhač
• [MK] Метла за лисја бензина • [RU] Воздуходувка • [SL] Sesalnik za listje
• [EL] Μηχανής αναρρόφησης φύλλων • [HR] Električni Usisavač / Puhalo Lišća • [FR] Aspirateur à essence • [IT] Aspirapolvere a benzina • [ES] Gasolina blivilo malplena • [PT] Soprador a gasolina

1250 W	7000 min ⁻¹
SPEED 252 ml/s	ml 1200
FUEL / OIL 25:1	8.300 kg
COLOR BOX	



Art.No	gross weight	barcode
077402	9.500 kg	3800972015630

BAG FOR BLOWER VACUUM

[BG] Торба за листосъбирач • [RO] Sac colector • [SR] Preklopna torba za skropljenje
• [MK] Преклопна вретена за скрепи • [RU] Мешок для листьев • [SL] Zložljiva torba za strgalo
• [EL] Πτυσσόμενη σακούλα απόξεσης • [HR] Sklopiva vrećica za struganje • [FR] Sac à raclette pliable • [IT] Sacca raschietto pieghevole • [ES] Foldanta kraketa sako • [PT] Saco de raspador dobrável



art. №	L (capacity)	BARCODE
075523 for RD-EBV03	35	3800123173509
075539 for RD-EBV04	35	3800972002067



PAPER CARD

BAG FOR GASOLINE BLOWER VACUUM

[BG] Торба за листосъбирач • [RO] Sac colector • [SR] Preklopna torba za skropljenje
• [MK] Преклопна вретена за скрепи • [RU] Мешок для листьев • [SL] Zložljiva torba za strgalo
• [EL] Πτυσσόμενη σακούλα απόξεσης • [HR] Sklopiva vrećica za struganje • [FR] Sac à raclette pliable • [IT] Sacca raschietto pieghevole • [ES] Foldanta kraketa sako • [PT] Saco de raspador dobrável



art. №	L (capacity)	BARCODE
140401 for RD-GBV05	30	3800972003729



PAPER CARD

SAFETY GLASSES WITH UVA400 AND ANTI SCRATCH PROTECTION RD

[BG] Очила предпазни • [RO] Ochelari de protectie • [SR] Zaštitne naočare • [MK] Заштитни очила • [RU] Защитные очки • [SL] Varnostna očala • [EL] Γαλιλά ασφαλείας • [HR] Zaštitne naočale • [FR] Lunettes de protection • [IT] Occhiali di sicurezza • [ES] Lentes de seguridad • [PT] Óculos de segurança



Art.No	gross weight	barcode
561401	0.200 kg	3800972016170

ELECTRIC TILLER RD-ET01J

[BG] Мотофреза електрическа • [RO] Electroculor • [SR] Baštenska freza • [MK] Електричен култиватор • [RU] Электрических культиватор • [SL] Električni prekopalnik • [EL] Φρεζα Ηλεκτρική • [HR] Električna koračica • [FR] Motoculteur électrique • [IT] Timone elettrico • [ES] Elektra cultivadora • [PT] Cultivadora

230V~ 50Hz	750 W
400 min ⁻¹	300mm
200mm	Ø220mm
7.100 kg	COLOR BOX



Art.No	gross weight	in carton	barcode
095101	8.700 kg	1 pcs	3800123163340

ELECTRIC TILLER RD-ET03

[BG] Мотофреза електрическа • [RO] Electroculor • [SR] Baštenska freza • [MK] Електричен култиватор • [RU] Электрических культиватор • [SL] Električni prekopalnik • [EL] Φρεζα Ηλεκτρική • [HR] Električna koračica • [FR] Motoculteur électrique • [IT] Timone elettrico • [ES] Elektra cultivadora • [PT] Cultivadora

230V~ 50Hz	1000 W
430 min ⁻¹	365mm
180mm	Ø220mm
10.800 kg	COLOR BOX



Art.No	gross weight	in carton	barcode
095113	15.540 kg	2 pcs	3800972003552

ELECTRIC TILLER RD-ET02

[BG] Мотофреза електрическа • [RO] Electroculor • [SR] Baštenska freza • [MK] Електричен култиватор • [RU] Электрических культиватор • [SL] Električni prekopalnik • [EL] Φρεζα Ηλεκτρική • [HR] Električna koračica • [FR] Motoculteur électrique • [IT] Timone elettrico • [ES] Elektra cultivadora • [PT] Cultivadora

230V~ 50Hz	1500 W
200 min ⁻¹	450mm
180mm	Ø220mm
10.00 kg	COLOR BOX



Art.No	gross weight	in carton	barcode
095108	13.500 kg	2 pcs	3800123174681

GASOLINE TILLER RD-T09

[BG] Мотофреза бензинова • [RO] Motoculor • [SR] Baštenska freza • [MK] Бензинов култиватор • [RU] Культиватор бензиновый • [SL] Bencin prekopalnik • [EL] Βενζίνη ηλεκτρική • [HR] Benzinska vrt freza • [FR] Motoculteur essence • [IT] Motozappa benzina • [ES] Benzina cultivador • [PT] Motocultivador

161cm ³	3600 min ⁻¹
600mm	Ø270mm
1200 ml	31 kg
3.0 kW	400 ml
150-260mm	31 kg



Art.No	gross weight	in carton	barcode
076904	36.000 kg	1 pcs	3800972015562

GASOLINE TILLER RD-T08

[BG] Мотофреза бензинова • [RO] Motoculor • [SR] Baštenska freza • [MK] Бензинов култиватор • [RU] Культиватор бензиновый • [SL] Bencin prekopalnik • [EL] Βενζίνη ηλεκτρική • [HR] Benzinska vrt freza • [FR] Motoculteur essence • [IT] Motozappa benzina • [ES] Benzina cultivador • [PT] Motocultivador

208cm ³	2500 min ⁻¹
1000mm	Ø350mm
3600 ml	86 kg
5.2 kW	2+1 GEAR
150-350mm	86 kg
600 ml	COLOR BOX



Art.No	gross weight	in carton	barcode
076903	93.400 kg		3800972015203

GASOLINE TILLER RD-T11

[BG] Мотофреза бензинова • [RO] Motocultor • [SR] Baštenska freza • [MK] Бензинов култиватор • [RU] Культиватор бензиновый • [SL] Bencin prekopalnik • [EL] Βενζίνη ηλεκτρική • [HR] Benzinska vrt freza • [FR] Motoculteur essence • [IT] Motozappa benzina • [ES] Benzina cultivador • [PT] Motocultivador



Art.No	gross weight	barcode
076908	99.500 kg	3800972018037

GASOLINE TILLER RD-T03

[BG] Мотофреза бензинова • [RO] Motocultor • [SR] Baštenska freza • [MK] Бензинов култиватор • [RU] Культиватор бензиновый • [SL] Bencin prekopalnik • [EL] Βενζίνη ηλεκτρική • [HR] Benzinska vrt freza • [FR] Motoculteur essence • [IT] Motozappa benzina • [ES] Benzina cultivador • [PT] Motocultivador



Art.No	gross weight	barcode
095102	107.000 kg	3800123170867

GASOLINE TILLER RD-T07

[BG] Мотофреза бензинова • [RO] Motocultor • [SR] Baštenska freza • [MK] Бензинов култиватор • [RU] Культиватор бензиновый • [SL] Bencin prekopalnik • [EL] Βενζίνη ηλεκτρική • [HR] Benzinska vrt freza • [FR] Motoculteur essence • [IT] Motozappa benzina • [ES] Benzina cultivador • [PT] Motocultivador



Art.No	gross weight	barcode
095112	107.800 kg	3800972001404

GASOLINE TILLER RD-T06

[BG] Мотофреза бензинова • [RO] Motocultor • [SR] Baštenska freza • [MK] Бензинов култиватор • [RU] Культиватор бензиновый • [SL] Bencin prekopalnik • [EL] Βενζίνη ηλεκτρική • [HR] Benzinska vrt freza • [FR] Motoculteur essence • [IT] Motozappa benzina • [ES] Benzina cultivador • [PT] Motocultivador

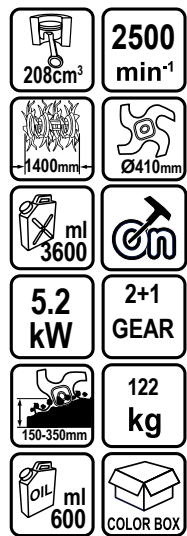

Art.No	gross weight	barcode
095111	131.600 kg	3800972000834

GASOLINE TILLER RD-T10

[BG] Мотофреза бензинова • [RO] Motocultor • [SR] Baštenska freza • [MK] Бензинов култиватор • [RU] Культиватор бензиновый • [SL] Bencin prekopalnik • [EL] Βενζίνη ηλεκτρική • [HR] Benzinska vrt freza • [FR] Motoculteur essence • [IT] Motozappa benzina • [ES] Benzina cultivador • [PT] Motocultivador



Art.No	gross weight	barcode
076905	123 kg	3800972015579

TRAILER FOR POWER TILLER RD-T03

[BG] Ремарке за мотофреза бензинова RD-T03 • [RO] Remorcă • [SR] Prikolica • [MK] Приколка • [RU] Прицеп для мотоблока • [SL] Prikolica • [EL] Τρέιλερ • [HR] Prikolica • [FR] Remorque de remorque de fraissage d'essence • [IT] Rimorchio del rimorchio di macinazione della benzina • [ES] Antaúfilmo de benzina muelejo • [PT] Reboque para trituração a gasolina



0.4T

75 kg

Dimensions: 2650 x 850 x 850 mm

- Loading area: 1m²
- High pass
- Ground clearance: 200 mm

Art.No	barcode
076907	3800123174544

EARTH AUGER

[BG] Моторен свърдел • [RO] Motoburghiu • [SR] Motorna bušilica zemlje • [MK] Моторна дупчалка • [RU] Мотобур • [SL] Vrtalnik za zemljo • [EL] Τριβέλα - Γεωτρύπανο Βενζίνης • [HR] Motorna bušilica za zemlju • [FR] Perceuse à essence • [IT] Trapano a benzina • [ES] Benzina grundo • [PT] Abre-buracos



Art.No	gross weight	barcode
095109 RD-EA01	9.880 kg	3800123174858
095114 RD-EA02 with drill bit 200x820mm	13.730 kg	3800972017269

ELECTRIC SNOW THROWER RD-ST01

[BG] Електрически снегорин • [RO] Plug de zapada • [SR] Čistač za sneg električni • [MK] Чистач за снег електрични • [RU] Снегоуборщик электрический • [SL] Električna snežna freza • [EL] Ηλεκτρικό Εκχιονιστικό • [HR] Freza za snijeg • [FR] Souffleuse à neige électrique • [IT] Spazzaneve elettrico • [ES] Elektra jetaja neĝo • [PT] Limpa-neves elétrico



Art.No	gross weight	barcode
095105	6.000 kg	3800123174094

ANTI VIBRATION SYSTEM FOR EARTH AUGER

[BG] Приставка антивибрационна за моторен свърдел • [RO] Cuplaj antivibratii pentru motoburghiu • [SR] Opruga za motorna bušilica zemlje • [MK] Пружина за моторна дупчалка • [RU] Пружина для сверло земли газоллина • [SL] Vzmet za vrtalnik za zemljo • [EL] Ελατήριο τριβέλα - γεωτρύπανο βενζίνης • [HR] Opruge za motorna bušilica za zemlju • [FR] Ressort pour perceuse à essence • [IT] Molla per trapano benzina a terra • [ES] Printempo por grunda benzino borilo • [PT] Sistema anti-vibração p/ abre buracos



Art. №	size	barcode
110270 RD-EA01	Ø20x20mm	3800123174957

ELECTRIC SNOW THROWER RD-ST02

[BG] Електрически снегорин • [RO] Plug de zapada • [SR] Čistač za sneg električni • [MK] Чистач за снег електрични • [RU] Снегоуборщик электрический • [SL] Električna snežna freza • [EL] Ηλεκτρικό Εκχιονιστικό • [HR] Freza za snijeg • [FR] Souffleuse à neige électrique • [IT] Spazzaneve elettrico • [ES] Elektra jetaja neĝo • [PT] Limpa-neves elétrico



Art.No	gross weight	barcode
095106	12.000 kg	3800123174100

DRILL FOR EARTH AUGER

[BG] Свърдело за моторен свърдел • [RO] Burghiu de pamant • [SR] Burgije za bušač • [MK] Бургија за моторна дупчалка • [RU] Сверло земли • [SL] Sveder za zemljo • [EL] Αρίδα τριβέλας • [HR] Burgije za motorna bušilica za zemlju • [FR] Forage terrestre • [IT] Trapano a terra • [ES] Tera borilo • [PT] Broca à abre-buracos



Art. №	size	barcode
110267 for RD-EA01	Ø100x820mm	3800123174889



Art. №	size	barcode
110268 for RD-EA01	Ø150x820mm	3800123174896



Art. №	size	barcode
110269 for RD-EA01	Ø200x820mm	3800123174902



GASOLINE SNOW THROWER RD-GST03

[BG] Бензинов снегорин • [RO] Plug de zapada pe benzină • [SR] Benzinska snovflake
• [MK] Бензински снег • [RU] Бензиновый снегоочиститель • [SL] Bencin za sneg • [EL] Γερανός
χιονίου βενζίνης • [HR] Vasač snijega za benzin • [FR] Souffleuse à essence • [IT] Benzina spaz-
zaneve • [ES] Benzina jetilo • [PT] Limpa-neves a gasolina



Art.No	gross weight	barcode
076901	54.000 kg	3800972003439

GASOLINE SNOW THROWER RD-GST04

[BG] Бензинов снегорин • [RO] Plug de zapada pe benzină • [SR] Benzinska snovflake
• [MK] Бензински снег • [RU] Бензиновый снегоочиститель • [SL] Bencin za sneg • [EL] Γερανός
χιονίου βενζίνης • [HR] Vasač snijega za benzin • [FR] Souffleuse à essence • [IT] Benzina spaz-
zaneve • [ES] Benzina jetilo • [PT] Limpa-neves a gasolina



Art.No	gross weight	barcode
076902	113.000 kg	3800972003446

GRASS TRIMMER RD-GT26

[BG] Косачка-тример • [RO] Trimmer pentru iarba • [SR] Trimer za travu • [MK] Косилка за трева
• [RU] Электрический тример • [SL] Električni obrezovalnik trave • [EL] Ηλεκτρικό χορτοκοπτικό
• [HR] Trimer za travu • [FR] Trimmer électrique • [IT] Trimmer elettrico • [ES] Herbo tondilo • [PT]
Aparador de relva



Art.No	gross weight	in cartoon	barcode
075544	1.500 kg	15 pcs	3800972009431

GRASS TRIMMER RD-GT11Q

[BG] Косачка-тример • [RO] Trimmer pentru iarba • [SR] Trimer za travu • [MK] Косилка за трева
• [RU] Электрический тример • [SL] Električni obrezovalnik trave • [EL] Ηλεκτρικό χορτοκοπτικό
• [HR] Trimer za travu • [FR] Trimmer électrique • [IT] Trimmer elettrico • [ES] Herbo tondilo • [PT]
Aparador de relva



Art.No	gross weight	in cartoon	barcode
075507	2.200 kg	8 pcs	3800123163173

TRIMMER LINE ON SPOOL FOR GRASS TRIMMER

[BG] Корда с макара за косачка-тример • [RO] Fir rezerva trimmer • [SR] Najlon za trimer • [MK] Конец за косилка
• [RU] Леска для триммера • [SL] Najlonska nitka za obrezovalnik trave • [EL] Κεφαλή μεσινέζας • [HR] Najlonska rezna glava s dvije niti • [FR] Trimmer Line sur bobine pour
tondeuse à gazon • [IT] Il cavo con un mulinello tagliaerba • [ES] La šnuro kun veturilo-trimmerilo • [PT] O cabo com um carreto aparador

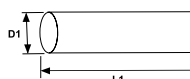

art. №	D1 (mm)	L1 (m)	BARCODE
110222 for RD-GT11,20	1.4	3	3800123163975
110223 for RD-GT11,20,26	1.2	3	3800123163982

GRASS TRIMMER RD-GT21

[BG] Косачка-тример • [RO] Trimmer pentru iarba • [SR] Trimer za travu • [MK] Косилка за трева
• [RU] Электрический тример • [SL] Električni obrezovalnik trave • [EL] Ηλεκτρικό χορτοκοπτικό
• [HR] Trimer za travu • [FR] Trimmer électrique • [IT] Trimmer elettrico • [ES] Herbo tondilo • [PT]
Aparador de relva

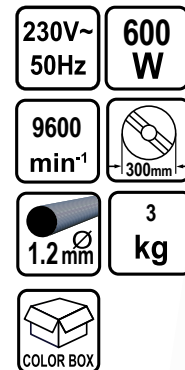

Art.No	gross weight	in cartoon	barcode
075525	3.230 kg	4 pcs	3800123174155

TRIMMER LINE ON SPOOL WITH CAP FOR GRASS TRIMMER

[BG] Корда с макара и шайба за косачка-тример • [RO] Fir rezerva trimmer cu disc • [SR] Najlon za trimer • [MK] Конец за косилка • [RU] Леска для триммера • [SL] Najlonska nitka za obrezovalnik trave • [EL] Κεφαλή μεσινέζας • [HR] Najlonska rezna glava s dvije niti • [FR] Trimmer Line sur bobine pour tondeuse à gazon • [IT] Il cavo con un mulinello tagliaerba • [ES] La šnuro kun veturilo-trimmerilo • [PT] O cabo com um carreto aparador



art. №	barcode
110261	3800123174469
110260 for RD-GT21	3800123174452

HEARING PROTECTION WITH VISOR RD

[BG] Антифони с визьор • [RO] Protectie auditiva cu vizor • [SR] Zaštita za sluh sa viziorom • [MK] Заштита за слух со визир • [RU] Защита органов слуха с козырьком • [SL] Zaščita sluha z vizirjem • [EL] Προστασία ακοής με γέισο • [HR] Zaštita sluha s viziorom • [FR] Protection auditive avec visière • [IT] Protezione dell'udito con visiera • [ES] Protección auditiva con visera • [PT] Proteção auditiva com viseira



art. №	barcode
561414	3800972026353

ELECTRIC BRUSH CUTTER WITH BLADE AND TRIMMER HEAD AND DETACHABLE SHAFT RD-EBC02

[BG] Коса електрическа с нож и корда съваема • [RO] Trimmer pentru gazon • [SR] Trimer za travu • [MK] Рачна косилка електрична • [RU] Электрический триммер - газонокосилка • [SL] Električna kosa • [EL] Θαμνοκοπτικό ηλεκτρικό με λαβή • [HR] Motorna kosa • [FR] Débroussaillouse électrique • [IT] Decespugliatore elettrico • [ES] Elektra trançilo • [PT] Roçadora elétrica

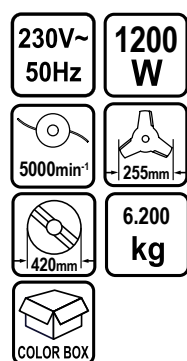

Art.No	gross weight	in carton	barcode
075517	6.700 kg	4 pcs	3800123171413

ELECTRIC BRUSH CUTTER WITH BLADE AND TRIMMER HEAD AND DETACHABLE SHAFT RD-EBC06

[BG] Коса електрическа с нож и корда съваема • [RO] Trimmer pentru gazon • [SR] Trimer za travu • [MK] Рачна косилка електрична • [RU] Электрический триммер - газонокосилка • [SL] Električna kosa • [EL] Θαμνοκοπτικό ηλεκτρικό με λαβή • [HR] Motorna kosa • [FR] Débroussaillouse électrique • [IT] Decespugliatore elettrico • [ES] Elektra trançilo • [PT] Roçadora elétrica



Art.No	gross weight	barcode
075547	7.000 kg	3800972015395

ELECTRIC BRUSH CUTTER WITH BLADE AND TRIMMER HEAD DETACHABLE SHAFT RD-EBC08

[BG] Коса електрическа с нож и корда съваема • [RO] Trimmer pentru gazon • [SR] Trimer za travu • [MK] Рачна косилка електрична • [RU] Электрический триммер - газонокосилка • [SL] Električna kosa • [EL] Θαμνοκοπτικό ηλεκτρικό με λαβή • [HR] Motorna kosa • [FR] Débroussaillouse électrique • [IT] Decespugliatore elettrico • [ES] Elektra trançilo • [PT] Roçadora elétrica

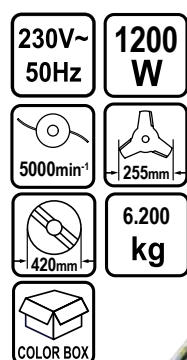

Art.No	gross weight	in carton	barcode
075558	6.200 kg	4 pcs	3800972026551

ELECTRIC BRUSH CUTTER WITH BLADE AND TRIMMER HEAD AND DETACHABLE SHAFT RD-EBC07

[BG] Коса електрическа с нож и корда съваема • [RO] Trimmer pentru gazon • [SR] Trimer za travu • [MK] Рачна косилка електрична • [RU] Электрический триммер - газонокосилка • [SL] Električna kosa • [EL] Θαμνοκοπτικό ηλεκτρικό με λαβή • [HR] Motorna kosa • [FR] Débroussaillouse électrique • [IT] Decespugliatore elettrico • [ES] Elektra trançilo • [PT] Roçadora elétrica



Art.No	gross weight	barcode
075548	7.300 kg	3800072015401

GASOLINE BRUSH CUTTER WITH BLADE AND TRIMMER HEAD RD-GBC22

[BG] Коса бензинова с нож и корда съваема • [RO] Motocoasa pe benzina • [SR] Motorni trimmer za travu [MK] Бензински тример • [RU] Бензиновый триммер - газонокосилка • [SL] Motorna kosa • [EL] Βενζίνη Θαμνοκοπτική • [HR] Motorna kosa • [FR] Débroussaillouse à essence avec lame et tête de coupe [IT] Decespugliatore a benzina con lama e testina • [ES] Trancilo por brulajo kun klingo kaj tondilo • [PT] Roçadora a gasolina



Art.No	gross weight	barcode
075549	19.000 kg	3800972015463

GASOLINE BRUSH CUTTER WITH BLADE AND TRIMMER HEAD RD-GBC10

[BG] Коса бензинова с нож и корда съваема • [RO] Motocoasa pe benzina • [SR] Motorni trimmer za travu [MK] Бензински тример • [RU] Бензиновый триммер - газонокосилка • [SL] Motorna kosa • [EL] Βενζίνη Θαμνοκοπτική • [HR] Motorna kosa • [FR] Débroussaillouse à essence avec lame et tête de coupe [IT] Decespugliatore a benzina con lama e testina • [ES] Trancilo por brulajo kun klingo kaj tondilo • [PT] Roçadora a gasolina



Art.No	gross weight	in cartoon	barcode
075510	9.160 kg	2 pcs	3800123166433

GASOLINE BRUSH CUTTER WITH BLADE AND TRIMMER HEAD RD-GBC20

[BG] Коса бензинова с нож и корда съваема • [RO] Motocoasa pe benzina • [SR] Motorni trimmer za travu [MK] Бензински тример • [RU] Бензиновый триммер - газонокосилка • [SL] Motorna kosa • [EL] Βενζίνη Θαμνοκοπτική • [HR] Motorna kosa • [FR] Débroussaillouse à essence avec lame et tête de coupe [IT] Decespugliatore a benzina con lama e testina • [ES] Trancilo por brulajo kun klingo kaj tondilo • [PT] Roçadora a gasolina



Art.No	gross weight	in cartoon	barcode
075543	9.340 kg	2 pcs	3800972009035

GASOLINE BRUSH CUTTER WITH BLADE AND TRIMMER HEAD RD-GBC14

[BG] Коса бензинова с нож и корда съваема • [RO] Motocoasa pe benzina • [SR] Motorni trimmer za travu [MK] Бензински тример • [RU] Бензиновый триммер - газонокосилка • [SL] Motorna kosa • [EL] Βενζίνη Θαμνοκοπτική • [HR] Motorna kosa • [FR] Débroussaillouse à essence avec lame et tête de coupe [IT] Decespugliatore a benzina con lama e testina • [ES] Trancilo por brulajo kun klingo kaj tondilo • [PT] Roçadora a gasolina



Art.No	gross weight	in cartoon	barcode
075534	9.950 kg	2 pcs	3800123174247

GASOLINE BRUSH CUTTER WITH BLADE AND TRIMMER HEAD RDP-GBC15

[BG] Коса бензинова с нож и корда съваема • [RO] Motocoasa pe benzina • [SR] Motorni trimmer za travu [MK] Бензински тример • [RU] Бензиновый триммер - газонокосилка • [SL] Motorna kosa • [EL] Βενζίνη Θαμνοκοπτική • [HR] Motorna kosa • [FR] Débroussaillouse à essence avec lame et tête de coupe [IT] Decespugliatore a benzina con lama e testina • [ES] Trancilo por brulajo kun klingo kaj tondilo • [PT] Roçadora a gasolina



Art.No	gross weight	in cartoon	barcode
075535	11.940 kg		3800123174384

GASOLINE BRUSH CUTTER WITH BLADE AND TRIMMER HEAD RD-GBC24 2K

[BG] Коса бензинова с нож и корда съваема • [RO] Motocoasa pe benzina • [SR] Motorni trimmer za travu [MK] Бензински тример • [RU] Бензиновый триммер - газонокосилка • [SL] Motorna kosa • [EL] Βενζίνη Θαμνοκοπτική • [HR] Motorna kosa • [FR] Débroussaillouse à essence avec lame et tête de coupe [IT] Decespugliatore a benzina con lama e testina • [ES] Trancilo por brulajo kun klingo kaj tondilo • [PT] Roçadora a gasolina



Art.No	gross weight	in cartoon	barcode
075011	11.940 kg		3800972020252

GASOLINE BRUSH CUTTER WITH BLADE AND TRIMMER HEAD RDP-GBC21

[BG] Коса бензинова с нож и корда съваема • [RO] Motocoasa pe benzina • [SR] Motorni trimmer za travu [MK] Бензински тример • [RU] Бензиновый триммер - газонокосилка • [SL] Motorna kosa • [EL] Βενζίνης Θαμνοκοπτικό • [HR] Motorna kosa • [FR] Débroussaillouse à essence avec lame et tête de coupe [IT] Decespugliatore a benzina con lama e testina • [ES] Trancilo por brulajo kun klingo kaj tondilo • [PT] Roçadora a gasolina

54 cm ³	255mm	4.5 kg
28 mm	3 000 min ⁻¹	COLOR BOX
440mm	2.4 mm	
2.2 kW		
FUEL / OIL 25:1	ml 800	



Art.No	gross weight	in cartoon	barcode
075550	5.150 kg		3800972015470

GASOLINE BRUSH CUTTER WITH BLADE AND TRIMMER HEAD GBC-25

[BG] Коса бензинова с нож и корда съваема • [RO] Motocoasa pe benzina • [SR] Motorni trimmer za travu [MK] Бензински тример • [RU] Бензиновый триммер - газонокосилка • [SL] Motorna kosa • [EL] Βενζίνης Θαμνοκοπτικό • [HR] Motorna kosa • [FR] Débroussaillouse à essence avec lame et tête de coupe [IT] Decespugliatore a benzina con lama e testina • [ES] Trancilo por brulajo kun klingo kaj tondilo • [PT] Roçadora a gasolina

54 cm ³	255mm	4.5 kg
28 mm	3 000 min ⁻¹	COLOR BOX
440mm	2.4 mm	
2.2 kW		
FUEL / OIL 25:1	ml 800	



Art.No	gross weight	in cartoon	barcode
075016	5.150 kg		3800972020214

GASOLINE BRUSH CUTTER WITH BLADE AND TRIMMER HEAD RD-GBC23

[BG] Коса бензинова с нож и корда съваема • [RO] Motocoasa pe benzina • [SR] Motorni trimmer za travu [MK] Бензински тример • [RU] Бензиновый триммер - газонокосилка • [SL] Motorna kosa • [EL] Βενζίνης Θαμνοκοπτικό • [HR] Motorna kosa • [FR] Débroussaillouse à essence avec lame et tête de coupe [IT] Decespugliatore a benzina con lama e testina • [ES] Trancilo por brulajo kun klingo kaj tondilo • [PT] Roçadora a gasolina

54 cm ³	255mm	4.5 kg
28 mm	3 000 min ⁻¹	COLOR BOX
440mm	2.4 mm	
1.5 kW		
FUEL / OIL 25:1	ml 1600	



Art.No	gross weight	in cartoon	barcode
075010	5.150 kg		3800972020214

GASOLINE BRUSH CUTTER WITH BLADE AND TRIMMER HEAD RD-GBC 11

[BG] Коса бензинова с нож и корда съваема • [RO] Motocoasa pe benzina • [SR] Motorni trimmer za travu [MK] Бензински тример • [RU] Бензиновый триммер - газонокосилка • [SL] Motorna kosa • [EL] Βενζίνης Θαμνοκοπτικό • [HR] Motorna kosa • [FR] Débroussaillouse à essence avec lame et tête de coupe [IT] Decespugliatore a benzina con lama e testina • [ES] Trancilo por brulajo kun klingo kaj tondilo • [PT] Roçadora a gasolina

40 cm ³	3 000 min ⁻¹	255mm
28 mm	2.4 mm	COLOR BOX
440mm		
0.8 kW	ml 1600	
26 mm	8.00 kg	



Art.No	gross weight	barcode
075513	8.880 kg	3800123171246

GASOLINE POLE SAW DETACHABLE SHAFT RD-GPS01

[BG] Кастрачка бензинова съваема • [RO] Fierăstrău pentru stâlp de benzină • [SR] Benzinska pila • [MK] Бензински столб пила • [RU] Бензиновая пила • [SL] Bencinska žaga • [EL] Πρίονι πόλων βενζίνης • [HR] Benzinska stupna pila • [FR] Scie à poteau à essence • [IT] Sega a benzina • [ES] Sierra de pértiga de gasolina • [PT] Serra de poste a gasolina

0.7 kW	3 000 min ⁻¹
FUEL / OIL 25:1	54 cm ³
ml 1600	
4.5 kg	
COLOR BOX	



Art.No	gross weight	in cartoon	barcode
075555	5.150 kg		3800972024304

POLE SAW HEAD WITH TUBE FOR GASOLINE BRUSH CUTTER RD-GBC 10, GBC 11 AND GBC20

[BG] Кастрачка за бензинова коса • [RO] Cap drijba prelungitor pentru motocoasa • [SR] Lančana testera za grane • [MK] Верижна пила за гранки • [RU] Пила для обрезки ветвей для • [SL] Verižna žaga za veje • [EL] Αλυσσοπριονο κοπταριού μπαταρίας • [HR] Teleskopska pila za motorna kosa • [FR] Scie pour branches de taille pour • [IT] Visto per i rami di potatura per • [ES] Vidis por rikollitiloj • [PT] Serra de podar c/ tubo p/ corta-sebes a gasolina

10" 250mm	0.50"(1.3mm)
AUTO	COLOR BOX
1.300 kg	



Art.No	gross weight	in cartoon	barcode
110216	2.000 kg		3800123161377

CHAIN FOR POLE SAW RD-GBC10, GBC11 AND GBC20

[BG] Верига за кастрачка • [RO] Lant pentru ferestrau el. cu lant • [SR] Lanac za lančanu testeru za grane • [MK] Ланец за верижна пила за гранки • [RU] Цепь для пила обрезки ветвей • [SL] Veriga za žaga za veje • [EL] Αλυσίδα αλυσοπριονο κοπταρίου μπαταρίας • [HR] Lanac za teleskopska pila • [FR] Chaîne pour tronçonner les branches • [IT] Catena per rami di taglio sega • [ES] Ceno por segaetbrančoj • [PT] Corrente moto-serra

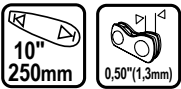

Art.No	gross weight	in cartoon	barcode
140111	0.130 kg	50 pcs	3800123166662

GUIDE BAR FOR POLE SAW RD-GBC10, GBC11 AND GBC20

[BG] Водеща шина за кастрачка • [RO] Lama ghidaj pentru ferestrau el. cu lant • [SR] Vodič lanca za lančanu testeru za grane • [MK] Водич за ланец за пила за гранки • [RU] Направляющая шина для пила обрезки ветвей • [SL] Meč za veriga za žaga za veje • [EL] Λαμα για αλυσοπριονο κοπταρίου μπαταρίας • [HR] Vodilica za teleskopska pila • [FR] Pneu de guidage pour la coupe de scie • [IT] Pneumatico di guida per taglio di seghe • [ES] Gvidu pneúo por segcinigilo • [PT] Guia de corte p/motoserra

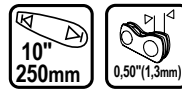

Art.No	gross weight	in cartoon	barcode
141303	0.390 kg	20 pcs	3800123166679

EXTENSION POLE FOR GASOLINE BRUSH CUTTER

[BG] Удължение за бензинова коса • [RO] Tija extensie pentru motocoasa • [SR] Produžetak za kosu sa benzinom • [MK] Продолжување за бензинска коса • [RU] Удлинитель для бензиновых фрезер • [SL] Bencinski rezkaro • [EL] Επέκταση για μαλλιά βενζίνης • [HR] Produžetak za benzinsku kosu • [FR] Extension pour cheveux à essence • [IT] Estensione per capelli benzina • [ES] Etendajo por benzinaj haroj • [PT] Extensão para cabelos a gasolina



Art.No	size	gross weight	barcode
110289	1m	0.900 kg	3800972015500

HEDGE TRIMMER HEAD AND TUBE FOR GASOLINE BRUSH CUTTER RD-GBC10, RD-GBC11

[BG] Резачка за храсти за бензинова коса • [RO] Trimmer pt. gard viu • [SR] Trimer za zivu ogradu • [MK] Косилка за жива ограда • [RU] Садовые ножницы-кусторезы • [SL] Škarje za živo mejo • [EL] Ψαλίδι μπροντουρας • [HR] Glava i cijev za rezanje živice za rezač četke za benzin • [FR] Tête et tube de taille-haie pour débroussaillage à essence • [IT] Testina tagliaspie e tubo per decespugliatore a benzina • [ES] Štranča kapo kaj tubo • [PT] Cabeça corta-sebes p/ roçadora a gasolina



Art.No	gross weight	barcode
110272	2.620 kg	3800972001732

TILLER ATTACHMENT FOR GASOLINE BRUSH CUTTER

[BG] Фреза за бензинова коса • [RO] Sapatoare pentru motocoasa • [SR] Glodalica za benzin • [MK] Секач за мелење на бензин • [RU] Бензиновый фрезер • [SL] Bencinski rezkaro • [EL] Φρεζάρισμα φρεζάρισμα βενζίνης • [HR] Rezač benzina • [FR] Fraise à essence • [IT] Fresa per benzina • [ES] Muelanta kurtenon • [PT] Fresa a gasolina



Art.No	size	gross weight	barcode
110288	320mm	1.500 kg	3800972015494

POLE SAW RD-PSO1

[BG] Кастрачка • [RO] Fierastrau electric telescopic de taiat crengi • [SR] Lančana testera za grane • [MK] Верижна пила за гранки • [RU] Пила для обрезки ветвей • [SL] Verižna žaga za veje • [EL] Αλυσοπριονο κοπταρίου μπαταρίας • [HR] Teleskopska pila za motorna kosu • [FR] Scie pour branches de taille pour • [IT] Visto per i rami di potatura per • [ES] Vidis por riktoličoj • [PT] Serra de podar corta-sebes a gasolina



Art.No	gross weight	in cartoon	barcode
075703	6.670 kg	2 pcs	3800123163784

CHAIN FOR POLE SAW FOR RD-PSO1

[BG] Верига за кастрачка • [RO] Lant pentru ferestrau el. cu lant • [SR] Lanac za lančanu testeru za grane • [MK] Ланец за верижна пила за гранки • [RU] Цепь для пила обрезки ветвей • [SL] Veriga za žaga za veje • [EL] Αλυσίδα αλυσοπρίοιο κονταριού μπαταρίας • [HR] Lanac za teleskopska pila • [FR] Chaîne pour tronçonner les branches • [IT] Catena per rami di taglio sega • [ES] Ceno por segçetbrançoj • [PT] Corrente moto-serra



Art.No	gross weight	in carton	barcode
140110	0.120 kg	50 pcs	3800123163791

GUIDE BAR FOR POLE SAW FOR RD-PSO1

[BG] Водеща шина за кастрачка • [RO] Lama ghidaj pentru ferestrau el. cu lant • [SR] Vodič lanca za lančanu testeru za grane • [MK] Водич за ланец за пила за гранки • [RU] Направляющая шина для пила обрезки ветвей • [SL] Meč za veriga za žaga za veje • [EL] Λαμα για αλυσοπρίοιο κονταριού μπαταρίας • [HR] Vodilica za teleskopska pila • [FR] Pneu de guidage pour la coupe de scie • [IT] Pneumatico di guida per taglio di seghe • [ES] Gvidu pneuõ por segcinigilo • [PT] Guia de corte p/motoserra



Art.No	gross weight	in carton	barcode
141302	0.310 kg	10 pcs	3800123163807

HAND PUSH LAWN MOWER RD-HLM37

[BG] Косачка • [RO] Masina de tuns iarba • [SR] Kosačice za travu • [MK] Косилка за трева • [RU] Ручная газонокосилка • [SL] Električna kosilnica • [EL] ηλεκτρική μηχανή γκαζόν • [HR] Električna kosilica • [FR] Tondeuse à gazon • [IT] Tosaerba elettrico • [ES] Gazontondilo • [PT] Corta relvas



Art.No	gross weight	barcode
075342	7.600 kg	3800972024243

LAWN MOWER RD-LM30

[BG] Косачка • [RO] Masina de tuns iarba • [SR] Kosačice za travu • [MK] Косилка за трева • [RU] Электрическая газонокосилка • [SL] Električna kosilnica • [EL] ηλεκτρική μηχανή γκαζόν • [HR] Električna kosilica • [FR] Tondeuse à gazon • [IT] Tosaerba elettrico • [ES] Gazontondilo • [PT] Corta relvas

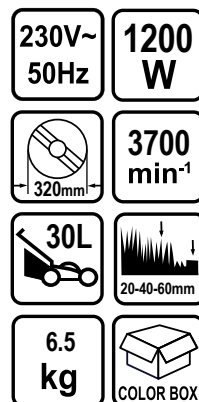

m² 400



BLADE FOR RD-LM30

Art.No	barcode
110294	3800972019485

Art.No	gross weight	barcode
075330	7.60 kg	3800972015517

LAWN MOWER RD-LM36

[BG] Косачка • [RO] Masina de tuns iarba • [SR] Kosačice za travu • [MK] Косилка за трева • [RU] Электрическая газонокосилка • [SL] Električna kosilnica • [EL] ηλεκτρική μηχανή γκαζόν • [HR] Električna kosilica • [FR] Tondeuse à gazon • [IT] Tosaerba elettrico • [ES] Gazontondilo • [PT] Corta relvas

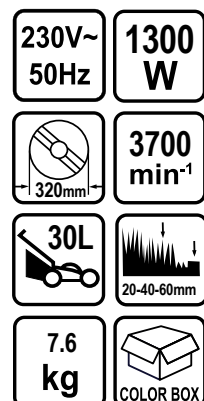

m² 400



Art.No	gross weight	barcode
075340	7.600 kg	3800972020207

LAWN MOWER RD-LM 31

[BG] Косачка • [RO] Masina de tuns iarba • [SR] Kosačice za travu • [MK] Косилка за трева • [RU] Электрическая газонокосилка • [SL] Električna kosilnica • [EL] ηλεκτρική μηχανή γκαζόν • [HR] Električna kosilica • [FR] Tondeuse à gazon • [IT] Tosaerba elettrico • [ES] Gazontondilo • [PT] Corta relvas



m² 500



BLADE FOR RD-LM31

Art.No	barcode
110295	3800972019492

Art.No	gross weight	barcode
075331	8.400 kg	3800972015524

LAWN MOWER RD-LM 32

[BG] Косачка • [RO] Masina de tuns iarba • [SR] Kosačice za travu • [MK] Косилка за трева
 • [RU] Электрическая газонокосилка • [SL] Električna kosilnica • [EL] ηλεκτρική μηχανή γκαζόν
 • [HR] Električna kosilica • [FR] Tondeuse à gazon • [IT] Tosaerba elettrico • [ES] Gazontondilo
 • [PT] Corta relvas

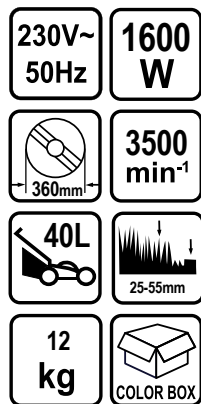

BLADE FOR RD-LM32

Art.No	barcode
110296	3800972019508



m² 700

Art.No	gross weight	barcode
075332	12.500 kg	3800972015531

SET LAWN MOWER AND GRASS TRIMMER RD-LMGTO1

[BG] Комплект косачка и тример • [RO] Masina de tuns iarba & trimmer • [SR] Kosilica za travu & trimmer • [MK] Косилка & тример • [RU] Косилка за трева и триммера • [SL] kosilnica & trimmer • [EL] Μηχανή γκαζόν • [HR] Kosačice za travu & trimmer • [FR] Tondeuse à gazon & trimmer • [IT] Tosaerba elettrico & Trimer • [ES] Gazontondilo & trimmer • [PT] Kit corta relvas e corta sebes

LAWN MOWER



GRASS TRIMMER



Art.No	gross weight	barcode
075327	13.500 kg	3800972009424

LAWN MOWER RD-LM33

[BG] Косачка • [RO] Masina de tuns iarba • [SR] Kosačice za travu • [MK] Косилка за трева
 • [RU] Электрическая газонокосилка • [SL] Električna kosilnica • [EL] ηλεκτρική μηχανή γκαζόν
 • [HR] Električna kosilica • [FR] Tondeuse à gazon • [IT] Tosaerba elettrico • [ES] Gazontondilo
 • [PT] Corta relvas

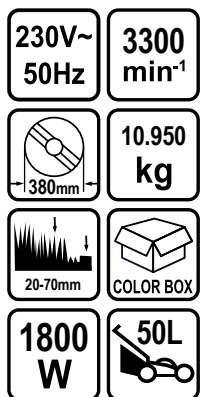

BLADE FOR RD-LM33

Art.No	barcode
110297	3800972019515



m² 800

Art.No	gross weight	barcode
075333	13.200 kg	3800972015548

LAWN MOWER RD-LM34

[BG] Косачка • [RO] Masina de tuns iarba • [SR] Kosačice za travu • [MK] Косилка за трева
 • [RU] Электрическая газонокосилка • [SL] Električna kosilnica • [EL] ηλεκτρική μηχανή γκαζόν
 • [HR] Električna kosilica • [FR] Tondeuse à gazon • [IT] Tosaerba elettrico • [ES] Gazontondilo
 • [PT] Corta relvas

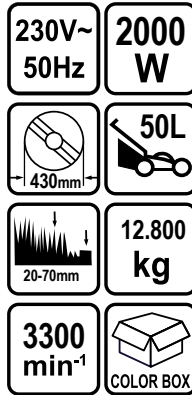

BLADE FOR RD-LM34

Art.No	barcode
110298	3800972019522



m² 1000

Art.No	gross weight	barcode
075334	14.400 kg	3800972015555

LAWN MOWER RD-LM23

[BG] Косачка • [RO] Masina de tuns iarba • [SR] Kosačice za travu • [MK] Косилка за трева
 • [RU] Электрическая газонокосилка • [SL] Električna kosilnica • [EL] ηλεκτρική μηχανή γκαζόν
 • [HR] Električna kosilica • [FR] Tondeuse à gazon • [IT] Tosaerba elettrico • [ES] Gazontondilo
 • [PT] Corta relvas



m² 500



Art.No	gross weight	barcode
075322	17.500 kg	3800972003620

BLADE FOR LAWN MOWER

[BG] Нож за косачка • [RO] Cutit pentru masina de tuns iarba • [SR] Sečivo za kosačica • [MK] Нож за косилка за трева • [RU] Нож для газонокосилка • [SL] Nož za travo za kosilnica • [EL] Ανταλλακτικό Μαχαίρι για Χλοοκοπτική • [HR] Oštrica • [FR] Couteau de tondeuse • [IT] Coltello falciante • [ES] Trancilo trancante • [PT] Faca de corte

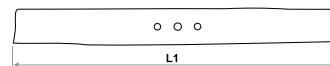

art. №	L1 (m)	BARCODE
110278 for RD-LM23	400mm (16")	3800972003637

GRASS BAG FOR LAWN

[BG] Кош за косачка • [RO] Pungă de iarbă pentru mașină de tuns iarba • [SR] Torba za travu • [MK] Torba za trava za kosilica za trava • [RU] Сумка для газонокосилки • [SL] Torba za kosilnico • [EL] Μηχανή γκαζόν • [HR] Kosilica kosh • [FR] Tondeuse à gazon • [IT] Tosaerba • [ES] Lignočambro • [PT] Saco de grama para cortador de grama



art. №	BARCODE
110277 for RD-LM23	3800972003644

SCARIFIER AND AERATOR 2 IN 1 RD-ESCO1

[BG] Аератор • [RO] Scarificator 2 in 1 • [SR] Serifikator i aerator • [MK] Скарифikator и аератор • [RU] Скарифikator и аератор • [SL] Škarje in aerator • [EL] Διασκόρπιτής και αεριστήρας • [HR] Šerifikator i aerator • [FR] Scarificateur et aérateur • [IT] Scarificatore e aeratore • [ES] Scarifier kaj aeratoro • [PT] Escarificador e aerador

230V~ 50Hz	1400 W	4200 min ⁻¹
30L	5x CENTRAL WORKING DEPTH ADJUSTMENT	LONG LIFE BLADES 320mm
LONG LIFE HIGH-GRADE STEEL 320mm	10.2 kg	COLOR BOX

m² 1200



Art.No	gross weight	barcode
075337	11.200 kg	3800972015920

SCARIFIER AND AERATOR 2 IN 1 RD-ESCO2

[BG] Аератор • [RO] Scarificator 2 in 1 • [SR] Serifikator i aerator • [MK] Скарифikator и аератор • [RU] Скарифikator и аератор • [SL] Škarje in aerator • [EL] Διασκόρπιτής και αεριστήρας • [HR] Šerifikator i aerator • [FR] Scarificateur et aérateur • [IT] Scarificatore e aeratore • [ES] Scarifier kaj aeratoro • [PT] Escarificador e aerador

230V~ 50Hz	1600 W	4000 min ⁻¹
50L	5x CENTRAL WORKING DEPTH ADJUSTMENT	LONG LIFE BLADES 320mm
LONG LIFE HIGH-GRADE STEEL 320mm	9.600 kg	COLOR BOX

m² 1400



Art.No	gross weight	barcode
075338	11.500 kg	3800972015937

SHREDDER RD-ESH01

[BG] Клонотрошачка • [RO] Tocator frunze si crengi • [SR] Rezač grana • [MK] Уништувач за гранки • [RU] Шредер для веток • [SL] Shredder za veje • [EL] Τεμαχίζων • [HR] Shredder • [FR] Shredder • [IT] Distruttore • [ES] Shredder [PT] Destruidora

230V~ 50Hz	2400 W
13.5 kg	4500 min ⁻¹
Ø40	COLOR BOX



Art.No	gross weight	barcode
075336	14.500 kg	3800972015944

SHREDDER RD-ESH02

[BG] Клонотрошачка • [RO] Tocator frunze si crengi • [SR] Rezač grana • [MK] Уништувач за гранки • [RU] Шредер для веток • [SL] Shredder za veje • [EL] Τεμαχίζων • [HR] Shredder • [FR] Shredder • [IT] Distruttore • [ES] Shredder [PT] Destruidora

230V~ 50Hz	2800 W
50 L	Ø45
42 min ⁻¹	COLOR BOX
24.600 kg	



Art.No	gross weight	barcode
075339	25.500 kg	3800972015951

GASOLINE LAWN MOWER RD-GLM01S

[BG] Косачка бензинова • [RO] Motocoasa pe benzina • [SR] Kosačica benzinska • [MK] Бензинска косилка за трава • [RU] Бензиновая газонокосилка • [SL] Bencina kosilnica • [EL] Χλοοκοπτικές μηχανές γκαζόν • [HR] Motorna kosilica • [FR] Tondeuse à essence • [IT] Rasaerba benzina • [ES] Gasolina gazono • [PT] Corta relvas a gasolina

125 cm ³	2000 W
40L	1500 ml
25-75mm	400mm
3600 min ⁻¹	15.5 kg
COLOR BOX	COLOR BOX

BLADE FOR LAWN MOWER

art. №	barcode
110203 for RD-GLM01	3800123141584



m² 900

Art.No	gross weight	barcode
110105	20.080 kg	3800123141546

GASOLINE LAWN MOWER SELF-PROPELLED RD-GLM07

[BG] Косачка бензинова самоходна • [RO] Motocoasa pe benzina • [SR] Kosačica benzinska • [MK] Бензинска косилка за трава • [RU] Бензиновая газонокосилка • [SL] Bencina kosilnica • [EL] Χλοοκοπτικές μηχανές γκαζόν • [HR] Motorna kosilica • [FR]Tondeuse à essence autopropulsée • [IT] Rasaerba a benzina semovente • [ES] Benzina gazetara tondilo • [PT] Corta relvas a gasolina

125cm ³	2000 W
45L	ml 1300
25-75mm	
2900 min⁻¹	24.00 kg
410mm	COLOR BOX

BLADE FOR RD-GLM07

Art.No	barcode
110300	3800972019546



m² 1200

Art.No	gross weight	barcode
075002	26.000 kg	3800972015296

GASOLINE LAWN MOWER SELF-PROPELLED RD-GLM08

[BG] Косачка бензинова самоходна • [RO] Motocoasa pe benzina • [SR] Kosačica benzinska • [MK] Бензинска косилка за трава • [RU] Бензиновая газонокосилка • [SL] Bencina kosilnica • [EL] Χλοοκοπτικές μηχανές γκαζόν • [HR] Motorna kosilica • [FR]Tondeuse à essence autopropulsée • [IT] Rasaerba a benzina semovente • [ES] Benzina gazetara tondilo • [PT] Corta relvas a gasolina

144cm ³	2500 W
65L	ml 800
30-80mm	
2800 min⁻¹	8 x CENTRAL WORKING DEPTH ADJUSTMENT
460mm	ml 500

BLADE FOR RD-GLM08

Art.No	barcode
110301	3800972019553



m² 1600

Art.No	gross weight	barcode
075003	31.200 kg	3800972015289

GASOLINE LAWN MOWER SELF-PROPELLED RD-GLM05W

[BG] Косачка бензинова самоходна • [RO] Motocoasa pe benzina • [SR] Kosačica benzinska • [MK] Бензинска косилка за трава • [RU] Бензиновая газонокосилка • [SL] Bencina kosilnica • [EL] Χλοοκοπτικές μηχανές γκαζόν • [HR] Motorna kosilica • [FR]Tondeuse à essence autopropulsée • [IT] Rasaerba a benzina semovente • [ES] Benzina gazetara tondilo • [PT] Corta relvas a gasolina

125cm ³	1700 W
60L	ml 1300
25-75mm	
2900 min⁻¹	26.00 kg
460mm	COLOR BOX



m² 1600

Art.No	gross weight	barcode
075012	26.000 kg	3800972023864

GASOLINE LAWN MOWER SELF-PROPELLED RD-GLM09

[BG] Косачка бензинова самоходна • [RO] Motocoasa pe benzina • [SR] Kosačica benzinska • [MK] Бензинска косилка за трава • [RU] Бензиновая газонокосилка • [SL] Bencina kosilnica • [EL] Χλοοκοπτικές μηχανές γκαζόν • [HR] Motorna kosilica • [FR]Tondeuse à essence autopropulsée • [IT] Rasaerba a benzina semovente • [ES] Benzina gazetara tondilo • [PT] Corta relvas a gasolina

196cm ³	3200 W
ml 850	510mm
30-80mm	
2800 min⁻¹	65L
ml 450	8 x CENTRAL WORKING DEPTH ADJUSTMENT

BLADE FOR RD-GLM09

Art.No	barcode
110302	3800972019560



m² 1900

Art.No	gross weight	barcode
075004	38.000 kg	3800972015302

GASOLINE LAWN MOWER SELF-PROPELLED RD-GLM10

[BG] Косачка бензинова самоходна • [RO] Motocoasa pe benzina • [SR] Kosačica benzinska • [MK] Бензинска косилка за трава • [RU] Бензиновая газонокосилка • [SL] Bencina kosilnica • [EL] Χλοοκοπτικές μηχανές γκαζόν • [HR] Motorna kosilica • [FR]Tondeuse à essence autopropulsée • [IT] Rasaerba a benzina semovente • [ES] Benzina gazetara tondilo • [PT] Corta relvas a gasolina

196cm ³	3200 W
ml 850	530mm
25-55mm	
2800 min⁻¹	70L
ml 450	8 x CENTRAL WORKING DEPTH ADJUSTMENT

BLADE FOR RD-GLM10

Art.No	barcode
110307	3800972023369



m² 2500

Art.No	gross weight	barcode
075005	40.000 kg	3800972015319

GASOLINE LAWN MOWER SELF-PROPELLED RD-GLM11 SOLO

[BG] Косачка бензинова самоходна • [RO] Motocoasa pe benzina • [SR] Kosačica benzinska • [MK] Бензинска косилка за трава • [RU] Бензиновая газонокосилка • [SL] Bencina kosilnica • [EL] Χλοοκοπτικές μηχανές γκαζόν • [HR] Motorna kosilica • [FR]Tondeuse à essence autopropulsée • [IT] Rasaerba a benzina semovente • [ES] Benzina gazetara tondilo • [PT] Corta relvas a gasolina

173cm ³	3700 W
ml 850	530mm
25-75mm	
2800 min⁻¹	70L
ml 450	8 x CENTRAL WORKING DEPTH ADJUSTMENT

BLADE FOR RD-GLM11

Art.No	barcode
110308	3800972015326



m² 2500

Art.No	gross weight	barcode
075006	40.000 kg	3800972015326

GASOLINE LAWN MOWER SELF-PROPELLED RD-GLM 12

[BG] Косачка бензинова самоходна • [RO] Motocoasa pe benzina • [SR] Kosačica benzinska • [MK] Бензинска косилка за трава • [RU] Бензиновая газонокосилка • [SL] Bencina kosilnica • [EL] Χλοοκοπτικές μηχανές γκαζόν • [HR] Motorna kosilica • [FR] Tondeuse à essence autopropulsée • [IT] Rasaerba a benzina semovente • [ES] Benzina gazetara tondilo • [PT] Corta relvas a gasolina

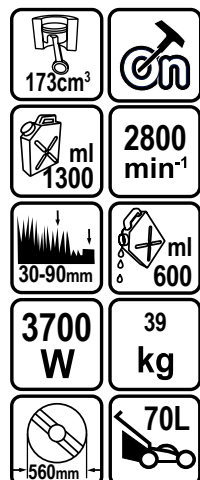
BLADE FOR RD-GLM 12

Art.No barcode
110303 3800972019577

m² 3000

Art.No gross weight barcode
075007 41.000 kg 3800972015333

SICKLE BAR GASOLINE MOWER RD-SBM0 1

[BG] Косачка бензинова палцова • [RO] Motocositoare • [SR] Kosačica benzinska • [MK] Бензинска косилка за трава • [RU] Бензиновая газонокосилка • [SL] Bencina kosilnica • [EL] Χλοοκοπτικές μηχανές γκαζόν • [HR] Motorna kosilica • [FR] Tondeuse à essence autopropulsée • [IT] Rasaerba a benzina semovente • [ES] Benzina gazetara tondilo • [PT] Corta relvas a gasolina

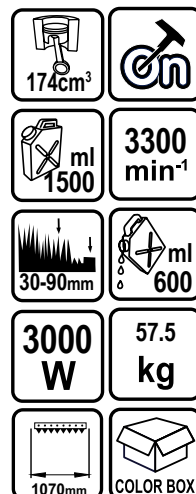
m² 3000

Art.No gross weight barcode
075008 67.500 kg 3800972015340

DRIVING CONNECTING ROD (109) FOR SICKLE BAR GASOLINE MOWER RD-SBM0 1

Art.No barcode
110304 3800972020306

DRIVEN CONNECTING ROD (122) SET FOR SICKLE BAR GASOLINE MOWER RD-SBM0 1

Art.No barcode
110305 3800972020313

BLADE SET FOR SICKLE BAR GASOLINE MOWER RD-SBM0 1

Art.No barcode
110306 3800972020320

GASOLINE SCARIFIER RD-GSC03

[BG] Аератор бензинов • [RO] Scarificator pe benzina • [SR] Serifikator i aerator • [MK] Скарификатор и аератор • [RU] Скарификатор и азратор • [SL] Škarje in aerator • [EL] Διασκορπιστής και αεριστήρας • [HR] Šerifikator i aerator • [FR] Scarificateur et aérateur • [IT] Scarificatore e aeratore • [ES] Scarifier kaj aeratoro • [PT] Escarificador e aerador

m² 2000

Art.No gross weight in cartoon barcode
075009 40.000 kg 3800972015357

HEDGE TRIMMER RD-HT06

[BG] Резачка за храсти • [RO] Trimmer pt. gard viu • [SR] Trimer za zivu ogradu • [MK] Косилка за жива ограда • [RU] Садовые ножницы-кусторезы • [SL] Škarje za živo mejo • [EL] Ψαλίδι Μπουρντούρας Ηλεκτρικό • [HR] Električne škare za živicu • [FR] Taille-haie • [IT] Tagliasiepi • [ES] Heğdezurilo • [PT] Costa-sebes

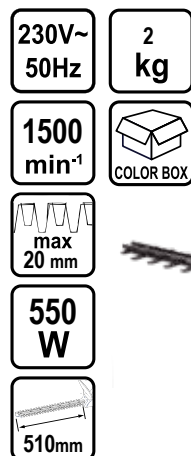

Art.No gross weight in cartoon barcode
075706 2.880 kg 4 pcs 3800123174872

HEDGE TRIMMER RD-HT05

[BG] Резачка за храсти • [RO] Trimmer pt. gard viu • [SR] Trimer za zivu ogradu • [MK] Косилка за жива ограда • [RU] Садовые ножницы-кусторезы • [SL] Škarje za živo mejo • [EL] Ψαλίδι Μπουρντούρας Ηλεκτρικό • [HR] Električne škare za živicu • [FR] Taille-haie • [IT] Tagliasiepi • [ES] Heğdezurilo • [PT] Costa-sebes

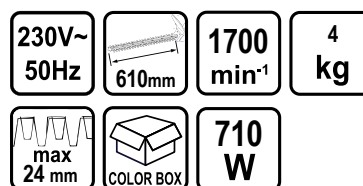

Art.No gross weight in cartoon barcode
075705 4.130 kg 4 pcs 3800123174834

GASOLINE HEDGE TRIMMER RD-GHT02

[BG] Резачка за храсти бензинова • [RO] Trimmer pt. gard viu • [SR] trimer za zivu ogradu • [MK] Косилка за жива ограда • [RU] Садовые ножницы-кусторезы • [SL] škarje za živo mejo • [EL] Ψαλίδι Μπορντούρας • [HR] Benzinske škare za živicu • [FR] Taille-haie • [IT] Tagliasiepi • [ES] Heğdezurilo • [PT] Corta-sebes a gasolina



Art.No	gross weight	barcode
075702	7.250 kg	3800123161384

KNAPSACK SPRAYER RD-BKMD03

[BG] Пръскачка • [RO] Vermorel • [SR] Prskalica • [MK] Пумпа прскалка • [RU] Рюкзак опрыскиватель [SL] Škropilnica • [EL] Ψεκαστήρας σακιδίου • [HR] Prskalica • [FR] Pulvérisateur à dos • [IT] Spruzzatore a zaino • [ES] Pulverizador mochila • [PT] Pulverizador manual

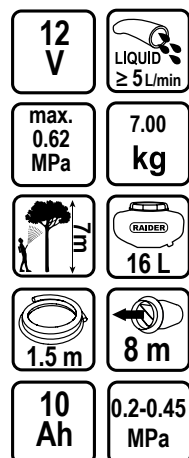

Art.No	gross weight	barcode
098102	7.600 kg	3800972009226

KNAPSACK SPRAYER RD-BKMD04

[BG] Пръскачка • [RO] Vermorel cu carucior si port USB • [SR] Prskalica • [MK] Пумпа прскалка • [RU] Рюкзак опрыскиватель [SL] Škropilnica • [EL] Ψεκαστήρας σακιδίου • [HR] Prskalica • [FR] Pulvérisateur à dos • [IT] Spruzzatore a zaino • [ES] Pulverizador mochila • [PT] Pulverizador manual

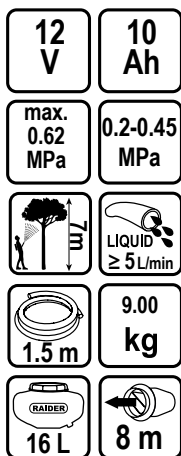

Art.No	gross weight	in cartoon	barcode
098103	9.880 kg		3800972009233

BATTERY PACK LI-ION 12V 8AH FOR KNAPSACK SPRAYES RD-BKMD03&04



Art.No	barcode
098104	3800972022577

CHARGER 12V FOR LI-ION KNAPSACK SPRAYES RD-BKMD03&04



Art.No	barcode
098105	3800972022584

KNAPSACK MIST DUSTER RD-KMD01J

[BG] Моторна пръскачка • [RO] Atomizor cu motor pe benzina • [SR] Prskalica ledna motorna • [MK] Пумпа прскалка на бензин • [RU] Рюкзак опрыскиватель • [SL] Motorno škropilnico • [EL] Ψεκαστήρας μηχανοκίνητος • [HR] Motorna prskalica • [FR] Pulvérisateur à dos • [IT] Spruzzatore a zaino • [ES] Pulverizador mochila • [PT] Pulverizador manual



Art.No	gross weight	barcode
110108	13.600 kg	3800123158292

KNAPSACK MIST DUSTER RD-KMD02

[BG] Моторна пръскачка • [RO] Atomizor cu motor pe benzina • [SR] Prskalica ledna motorna • [MK] Пумпа прскалка на бензин • [RU] Рюкзак опрыскиватель • [SL] Motorno škropilnico • [EL] Ψεκαστήρας μηχανοκίνητος • [HR] Motorna prskalica • [FR] Pulvérisateur à dos • [IT] Spruzzatore a zaino • [ES] Pulverizador mochila • [PT] Pulverizador manual



Art.No	gross weight	in cartoon	barcode
098101	13.000 kg		3800123174254

PERIPHERAL PUMP

[BG] Помпа водна • [RO] Pompa de apa • [SR] Pumpa • [MK] Водна пумпа • [RU] Насос • [SL] Črpalka za vodo [EL] Αντλία νερού • [HR] Pumpa za vodu • [FR] Pompe • [IT] Pompa • [ES] Bombo • [PT] Bomba periférica



Art.No	W	L/min	gross weight	in cartoon	barcode
070101 RD-PK60	370	35	4.520 kg	6 pcs	3800123123887
070115 RD-WP60	500	40	5.170 kg	6 pcs	3800123141539

PERIPHERAL PUMP

[BG] Помпа водна • [RO] Pompa de apa • [SR] Pumpa • [MK] Водна пумпа • [RU] Насос • [SL] Črpalka za vodo [EL] Αντλία νερού • [HR] Pumpa za vodu • [FR] Pompe • [IT] Pompa • [ES] Bombo • [PT] Bomba periférica

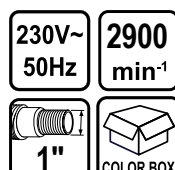

Art.No	W	L/min	H max	Smax	barcode
070104 RD-CPM158	750	96	28	8	3800123123481
070116 RD-WP158	850	120	35	9	3800123141881

PERIPHERAL PUMP RD-1.5DK20

[BG] Помпа водна • [RO] Pompa de apa • [SR] Pumpa • [MK] Водна пумпа • [RU] Насос • [SL] Črpalka za vodo [EL] Αντλία νερού • [HR] Pumpa za vodu • [FR] Pompe • [IT] Pompa • [ES] Bombo • [PT] Bomba periférica



Art.No	gross weight	barcode
070103	9.760 kg	3800123123511

CENTRIFUGAL PUMP RD-2DK20

[BG] Помпа водна • [RO] Pompa de apa • [SR] Pumpa • [MK] Водна пумпа • [RU] Насос • [SL] Črpalka za vodo [EL] Αντλία νερού • [HR] Pumpa za vodu • [FR] Pompe • [IT] Pompa • [ES] Bombo • [PT] Bomba periférica



Art.No	gross weight	barcode
070105	17.060 kg	3800123123528

SELF-PRIMING PUMP RD-JET100

[BG] Помпа водна • [RO] Pompa de apa • [SR] Pumpa • [MK] Водна пумпа • [RU] Насос • [SL] Črpalka za vodo [EL] Αντλία νερού • [HR] Pumpa za vodu • [FR] Pompe • [IT] Pompa • [ES] Bombo • [PT] Bomba periférica

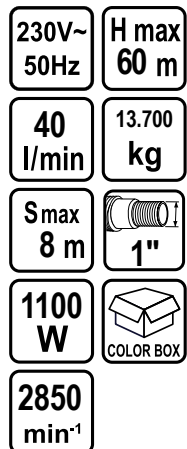

Art.No	gross weight	barcode
070117	14.100 kg	3800123115875

SELF-PRIMING PUMP RD-WP43

[BG] Помпа водна • [RO] Pompa de apa • [SR] Pumpa • [MK] Водна пумпа • [RU] Насос • [SL] Črpalka za vodo [EL] Αντλία νερού • [HR] Pumpa za vodu • [FR] Pompe • [IT] Pompa • [ES] Bombo • [PT] Bomba periférica



Art.No	gross weight	barcode
070151	6.400 kg	3800972015753

SELF-PRIMING PUMP RDP-WP44

[BG] Помпа водна • [RO] Pompa de apa • [SR] Pumpa • [MK] Водна пумпа • [RU] Насос
• [SL] Črpalka za vodo [EL] Αντλία νερού • [HR] Pumpa za vodu • [FR] Pompe • [IT] Pompa
• [ES] Bombo • [PT] Bomba periférica

RAIDER[®]
Pro

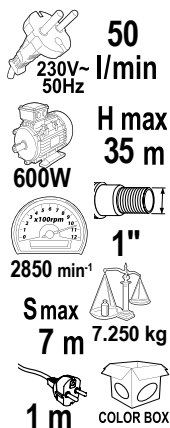

Art.No	gross weight	barcode
070152	6.900 kg	3800972015760

SUBMERSIBLE PUMP FOR CLEAN WATER RD-WP18

[BG] Помпа водна потопяема за чиста вода • [RO] Pompa submersibila pentru apa curata • [SR] Pumpa rotarajuća • [MK] Потопна пумпа • [RU] Насос Погружной • [SL] Potopna črpalka za vodo
• [EL] Υποβρύχια αντλία νερού • [HR] Potopna pumpa za čistu vodu • [FR] Pompe submersible • [IT] Pompa sommersibile • [ES] Sumergebla pumpilo • [PT] Bomba submersível



Art.No	gross weight	in cartoon	barcode
070121	4.310 kg	6 pcs	3800123161421

SELF-PRIMING PUMP RD-WP19

[BG] Помпа водна • [RO] Pompa de apa • [SR] Pumpa • [MK] Водна пумпа • [RU] Насос
• [SL] Črpalka za vodo [EL] Αντλία νερού • [HR] Pumpa za vodu • [FR] Pompe • [IT] Pompa
• [ES] Bombo • [PT] Bomba periférica

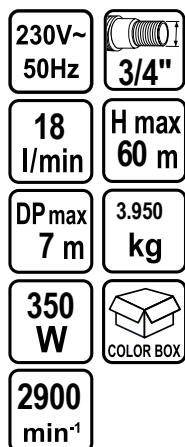

Art.No	gross weight	in cartoon	barcode
070122	4.430 kg	6 pcs	3800123161438

SELF-PRIMING PUMP RD-WP37

[BG] Помпа водна • [RO] Pompa de apa • [SR] Pumpa • [MK] Водна пумпа • [RU] Насос
• [SL] Črpalka za vodo [EL] Αντλία νερού • [HR] Pumpa za vodu • [FR] Pompe • [IT] Pompa
• [ES] Bombo • [PT] Bomba periférica



Art.No	gross weight	in cartoon	barcode
070144	5.130 kg	4 pcs	3800123174605

SUBMERSIBLE PUMP FOR SEWAGE WATER RD-WP002EX

[BG] Помпа водна потопяема за мръсна вода • [RO] Pompa submersibila pentru apa murdara
• [SR] Pumpa rotarajuća • [MK] Потопна пумпа • [RU] Насос Погружной • [SL] Potopna črpalka za vodo • [EL] Υποβρύχια αντλία νερού • [HR] Potopna pumpa za prljavu vodu • [FR] Pompe submersible pour eaux usées • [IT] Pompa sommersibile per acque reflue • [ES] Sumergebla pumpilo por kloakaĵa akvo • [PT] Bomba submersível



Art.No	gross weight	in cartoon	barcode
070106	6.680 kg	4 pcs	3800123124037

SUBMERSIBLE PUMP FOR SEWAGE WATER RDP-WP42

[BG] Помпа водна потопяема за мръсна вода • [RO] Pompa submersibila pentru apa murdara
• [SR] Pumpa rotarajuća • [MK] Потопна пумпа • [RU] Насос Погружной • [SL] Potopna črpalka za vodo • [EL] Υποβρύχια αντλία νερού • [HR] Potopna pumpa za prljavu vodu • [FR] Pompe submersible pour eaux usées • [IT] Pompa sommersibile per acque reflue • [ES] Sumergebla pumpilo por kloakaĵa akvo [PT] Bomba submersível

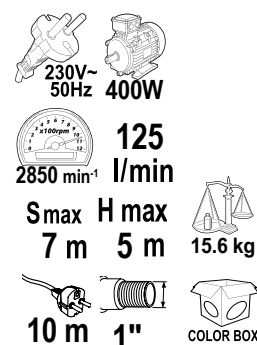

Art.No	gross weight	in cartoon	barcode
070150	15.950 kg	4 pcs	3800972015746

RAIDER[®]
Pro

SUBMERSIBLE PUMP FOR SEWAGE WATER RD-WP40

[BG] Помпа водна потопяема за мръсна вода • [RO] Pompa submersibila pentru apa murdara • [SR] Pumpa rotarajuća • [MK] Потопна пумпа • [RU] Насос Погружной • [SL] Potopna črpalka za vodo • [EL] Υποβρύχια αντλία νερού • [HR] Potopna pumpa za prijavu vodu • [FR] Pompe submersible pour eaux usées • [IT] Pompa sommergibile per acque reflue • [ES] Sumergebla pumpilo por kloakaja akvo • [PT] Bomba submersível

230V~ 50Hz	550 W
166 l/min	H max 7 m
DP max 7 m	1"
10m	4.8 kg
max 20mm	COLOR BOX



Art.No	gross weight	in carton	barcode
070147	5.000 kg	4 pcs	3800123174636

SUBMERSIBLE PUMP FOR SEWAGE WATER RD-WP12

[BG] Помпа водна потопяема за мръсна вода • [RO] Pompa submersibila pentru apa murdara • [SR] Pumpa rotarajuća • [MK] Потопна пумпа • [RU] Насос Погружной • [SL] Potopna črpalka za vodo • [EL] Υποβρύχια αντλία νερού • [HR] Potopna pumpa za prijavu vodu • [FR] Pompe submersible pour eaux usées • [IT] Pompa sommergibile per acque reflue • [ES] Sumergebla pumpilo por kloakaja akvo • [PT] Bomba submersível

230V~ 50Hz	550 W
2900 min ⁻¹	175 l/min
H max 7 m	DP max 7 m
1"	5.9 kg
COLOR BOX	



Art.No	gross weight	in carton	barcode
070110	6.380 kg	4 pcs	3800123127885

SUBMERSIBLE PUMP FOR SEWAGE WATER RD-WP38

[BG] Помпа водна потопяема за мръсна вода • [RO] Pompa submersibila pentru apa murdara • [SR] Pumpa rotarajuća • [MK] Потопна пумпа • [RU] Насос Погружной • [SL] Potopna črpalka za vodo • [EL] Υποβρύχια αντλία νερού • [HR] Potopna pumpa za prijavu vodu • [FR] Pompe submersible pour eaux usées • [IT] Pompa sommergibile per acque reflue • [ES] Sumergebla pumpilo por kloakaja akvo • [PT] Bomba submersível

230V~ 50Hz	750 W
225 l/min	H max 7.5m
DP max 7 m	1"
10m	7.800 kg
max 15mm	COLOR BOX



Art.No	gross weight	in carton	barcode
070145	6.750 kg	4 pcs	3800123174612

SUBMERSIBLE PUMP FOR SEWAGE WATER RD-WP39

[BG] Помпа водна потопяема за мръсна вода • [RO] Pompa submersibila pentru apa murdara • [SR] Pumpa rotarajuća • [MK] Потопна пумпа • [RU] Насос Погружной • [SL] Potopna črpalka za vodo • [EL] Υποβρύχια αντλία νερού • [HR] Potopna pumpa za prijavu vodu • [FR] Pompe submersible pour eaux usées • [IT] Pompa sommergibile per acque reflue • [ES] Sumergebla pumpilo por kloakaja akvo • [PT] Bomba submersível

230V~ 50Hz	1100 W
308 l/min	H max 8 m
DP max 7 m	1"
10m	7.400 kg
max 20mm	COLOR BOX



Art.No	gross weight	in carton	barcode
070146	7.750 kg	4 pcs	3800123174629

SUBMERSIBLE PUMP FOR SEWAGE WATER RDP-WP28

[BG] Помпа водна потопяема за мръсна вода • [RO] Pompa submersibila pentru apa murdara • [SR] Pumpa rotarajuća • [MK] Потопна пумпа • [RU] Насос Погружной • [SL] Potopna črpalka za vodo • [EL] Υποβρύχια αντλία νερού • [HR] Potopna pumpa za prijavu vodu • [FR] Pompe submersible pour eaux usées • [IT] Pompa sommergibile per acque reflue • [ES] Sumergebla pumpilo por kloakaja akvo • [PT] Bomba submersível

230V~ 50Hz	400W
2900 min ⁻¹	150 l/min
H max 5 m	DP max 5 m
3/4"-1.1/2"	max 35mm
10 m	4.8 kg



Art.No	gross weight	in carton	barcode
070135	5.250 kg	4 pcs	3800123166198

SUBMERSIBLE PUMP FOR SEWAGE WATER RDP-WP25

[BG] Помпа водна потопяема за мръсна вода • [RO] Pompa submersibila pentru apa murdara • [SR] Pumpa rotarajuća • [MK] Потопна пумпа • [RU] Насос Погружной • [SL] Potopna črpalka za vodo • [EL] Υποβρύχια αντλία νερού • [HR] Potopna pumpa za prijavu vodu • [FR] Pompe submersible pour eaux usées • [IT] Pompa sommergibile per acque reflue • [ES] Sumergebla pumpilo por kloakaja akvo • [PT] Bomba submersível

230V~ 50Hz	750W
2900 min ⁻¹	217 l/min
H max 8 m	DP max 7 m
3/4"-1.1/2"	max 30mm
10 m	6.5 kg



Art.No	gross weight	in carton	barcode
070132	6.750 kg	4 pcs	3800123166167

SUBMERSIBLE PUMP FOR SEWAGE WATER RDP-WP26

[BG] Помпа водна потопяема за мръсна вода • [RO] Pompa submersibila pentru apa murdara • [SR] Pumpa rotarajuća • [MK] Потопна пумпа • [RU] Насос Погружной • [SL] Potopna črpalka za vodo • [EL] Υποβρύχια αντλία νερού • [HR] Potopna pumpa za prijavu vodu • [FR] Pompe submersible pour eaux usées • [IT] Pompa sommergibile per acque reflue • [ES] Sumergible pumpilo por kloakaja akvo • [PT] Bomba submersível



Art.No	gross weight	in cartoon	barcode
070133	7.300 kg	4 pcs	3800123166174

SUBMERSIBLE PUMP FOR SEWAGE WATER RDP-WP27

[BG] Помпа водна потопяема за мръсна вода • [RO] Pompa submersibila pentru apa murdara • [SR] Pumpa rotarajuća • [MK] Потопна пумпа • [RU] Насос Погружной • [SL] Potopna črpalka za vodo • [EL] Υποβρύχια αντλία νερού • [HR] Potopna pumpa za prijavu vodu • [FR] Pompe submersible pour eaux usées • [IT] Pompa sommergibile per acque reflue • [ES] Sumergible pumpilo por kloakaja akvo • [PT] Bomba submersível



Art.No	gross weight	in cartoon	barcode
070134	8.630 kg	4 pcs	3800123166181

SUBMERSIBLE PUMP FOR CLEAN WATER RD-WP41

[BG] Помпа водна дълбочинна за чиста вода • [RO] Pompa submersibila pentru apa curate • [SR] Pumpa rotarajuća • [MK] Потопна пумпа • [RU] Насос погружной • [SL] Potopna črpalka za vodo • [EL] Υποβρύχια αντλία νερού • [HR] Potopna pumpa za čistu vodu • [FR] Pompe submersible pour l'eau propre • [IT] Pompa sommergibile peracqua pulita • [ES] Sumergible pumpilo por pura akvo • [PT] Bomba submersível



Art.No	gross weight	in cartoon	barcode
070148	12.880 kg		3800123174711

SUBMERSIBLE PUMP FOR CLEAN WATER RD-WP31

[BG] Помпа водна дълбочинна за чиста вода • [RO] Pompa submersibila pentru apa curate • [SR] Pumpa rotarajuća • [MK] Потопна пумпа • [RU] Насос погружной • [SL] Potopna črpalka za vodo • [EL] Υποβρύχια αντλία νερού • [HR] Potopna pumpa za čistu vodu • [FR] Pompe submersible pour l'eau propre • [IT] Pompa sommergibile peracqua pulita • [ES] Sumergible pumpilo por pura akvo • [PT] Bomba submersível



Art.No	gross weight	in cartoon	barcode
070138	14.010 kg		3800123166716

SUBMERSIBLE PUMP FOR CLEAN WATER RD-WP24

[BG] Помпа водна дълбочинна за чиста вода • [RO] Pompa submersibila pentru apa curate • [SR] Pumpa rotarajuća • [MK] Потопна пумпа • [RU] Насос погружной • [SL] Potopna črpalka za vodo • [EL] Υποβρύχια αντλία νερού • [HR] Potopna pumpa za čistu vodu • [FR] Pompe submersible pour l'eau propre • [IT] Pompa sommergibile peracqua pulita • [ES] Sumergible pumpilo por pura akvo • [PT] Bomba submersível

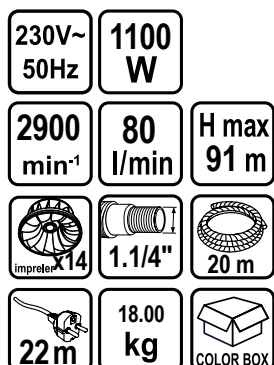

Art.No	gross weight	in cartoon	barcode
070131	20.410 kg		3800123164590

FOUNTAIN PUMP RD-WP35

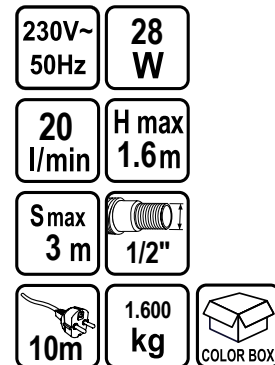

[BG] Помпа водна фонтан • [RO] Pompa fantana arteziana • [SR] Pumpa za fontanu • [MK] Пумпа за фонтану • [RU] Фонтанный насос • [SL] Črpalka za vodnjake • [EL] Αντλία σιντριβανιού • [HR] Pumpa za fontane • [FR] Pompe de fontaine • [IT] Pompa per fontana • [ES] Fonta pumpilo • [PT] Bomba de água



Art.No	gross weight	in cartoon	barcode
070142	1.720 kg	12 pcs	3800123174582

FOUNTAIN PUMP RD-WP21

[BG] Помпа водна фонтан • [RO] Pompa fantana arteziana • [SR] Pumpa za fontanu • [MK] Пумпа за фонтану • [RU] Фонтанный насос • [SL] Črpalka za vodnjake • [EL] Αντλία σιντριβανιού • [HR] Pumpa za fontane • [FR] Pompe de fontaine • [IT] Pompa per fontana • [ES] Fonta pumpilo • [PT] Bomba de água

230V~ 50Hz	50 W
33 l/min	H max 3 m
S max 2.5m	 1"
 10m	1.700 kg
	COLOR BOX



Art.No	gross weight	in carton	barcode
070124	2.010 kg	8 pcs	3800123161452

FOUNTAIN PUMP RD-WP36

[BG] Помпа водна фонтан • [RO] Pompa fantana arteziana • [SR] Pumpa za fontanu • [MK] Пумпа за фонтану • [RU] Фонтанный насос • [SL] Črpalka za vodnjake • [EL] Αντλία σιντριβανιού • [HR] Pumpa za fontane • [FR] Pompe de fontaine • [IT] Pompa per fontana • [ES] Fonta pumpilo • [PT] Bomba de água

230V~ 50Hz	75 W
43 l/min	H max 2.6m
S max 3 m	 1"
 10m	3.100 kg
	COLOR BOX



Art.No	gross weight	in carton	barcode
070143	3.430 kg	6 pcs	3800123174599

BOOSTER PUMP WITH PRESSURE TANK RD-WP800S

[BG] Хидрофор • [RO] Hidrofor • [SR] Hidropak • [MK] Хидрофор • [RU] Гидрофор • [SL] Ohišje črpalke in tlačna posoda • [EL] Μονάδα αντλίας πίεσης • [HR] Hidropak za vodu • [FR] Pompe de surpression avec réservoir sous pression • [IT] Pompa di aumento pressione con serbatoio a pressione • [ES] Akcelilio kun premotanko • [PT] Bomba de reforço e tanque

230V~ 50Hz	800 W
3 bar	H max 40 m
 1"	10.790 kg
53 l/min	
S max 7 m	COLOR BOX



Art.No	gross weight	in carton	barcode
071106	11.350 kg		3800972015784

BOOSTER PUMP WITH PRESSURE TANK RDP-WP800SW

[BG] Хидрофор • [RO] Hidrofor • [SR] Hidropak • [MK] Хидрофор • [RU] Гидрофор • [SL] Ohišje črpalke in tlačna posoda • [EL] Μονάδα αντλίας πίεσης • [HR] Hidropak za vodu • [FR] Pompe de surpression avec réservoir sous pression • [IT] Pompa di aumento pressione con serbatoio a pressione • [ES] Akcelilio kun premotanko • [PT] Bomba de reforço e tanque



230V~ 50Hz	800 W
3 bar	H max 40 m
 1"	12.100 kg
53 l/min	
S max 7 m	COLOR BOX



Art.No	gross weight	barcode
071105	12.600 kg	3800972015777

BOOSTER PUMP WITH PRESSURE TANK RD-WP1200J

[BG] Хидрофор • [RO] Hidrofor • [SR] Hidropak • [MK] Хидрофор • [RU] Гидрофор • [SL] Ohišje črpalke in tlačna posoda • [EL] Μονάδα αντλίας πίεσης • [HR] Hidropak za vodu • [FR] Pompe de surpression avec réservoir sous pression • [IT] Pompa di aumento pressione con serbatoio a pressione • [ES] Akcelilio kun premotanko • [PT] Bomba de reforço e tanque

230V~ 50Hz	1200 W
3 bar	H max 48 m
 1"	13.500 kg
64 l/min	
S max 7 m	COLOR BOX



Art.No	gross weight	in carton	barcode
071104	14.000 kg		3800123158360

BOOSTER PUMP WITH PRESSURE TANK RD-WP1200S

[BG] Хидрофор • [RO] Hidrofor • [SR] Hidropak • [MK] Хидрофор • [RU] Гидрофор • [SL] Ohišje črpalke in tlačna posoda • [EL] Μονάδα αντλίας πίεσης • [HR] Hidropak za vodu • [FR] Pompe de surpression avec réservoir sous pression • [IT] Pompa di aumento pressione con serbatoio a pressione • [ES] Akcelilio kun premotanko • [PT] Bomba de reforço e tanque

230V~ 50Hz	1200 W
3 bar	H max 48 m
 1"	11.790 kg
64 l/min	
S max 7 m	COLOR BOX



Art.No	gross weight	barcode
071107	12.350 kg	3800972017986

BOOSTER PUMP WITH PRESSURE TANK RD-WP1300

[BG] Хидрофор • [RO] Hidrofor • [SR] Hidropak • [MK] Хидрофор • [RU] Гидрофор • [SL] Ohišje črpalke in tlačna posoda • [EL] Μονάδα αντλίας πίεσης • [HR] Hidropak za vodu • [FR] Pompe de surpression avec réservoir sous pression • [IT] Pompa di aumento pressione con serbatoio a pressione • [ES] Akcello kun premotanko • [PT] Bomba de reforço e tanque

230V~ 50Hz	1300 W
3 bar	H max 48 m
1"	18.000 kg
75 l/min	 COLOR BOX
Smax 8 m	



Art.No	gross weight	in cartoon	barcode
070125	18.500 kg		3800123161469

BOOSTER PUMP WITH PRESSURE TANK RD-WP1300S

[BG] Хидрофор • [RO] Hidrofor • [SR] Hidropak • [MK] Хидрофор • [RU] Гидрофор • [SL] Ohišje črpalke in tlačna posoda • [EL] Μονάδα αντλίας πίεσης • [HR] Hidropak za vodu • [FR] Pompe de surpression avec réservoir sous pression • [IT] Pompa di aumento pressione con serbatoio a pressione • [ES] Akcello kun premotanko • [PT] Bomba de reforço e tanque

230V~ 50Hz	1300 W
3 bar	H max 48 m
1"	12.590 kg
80 l/min	 COLOR BOX
Smax 8 m	



Art.No	gross weight	in cartoon	barcode
071108	13.000 kg		3800972017993

ELECTRONIC BOOSTER PUMP RD-WP17

[BG] Помпа с електронен пресостат • [RO] Pompa de apa • [SR] Pumpa • [MK] Водна пумпа • [RU] Насос • [SL] črpalka za vodo • [EL] αντλία νερού • [HR] Pumpa sa elektroničke regulator tlaka • [FR] Pompe de surpression électronique • [IT] Pompa booster elettronica • [ES] Elektronika pumpilo • [PT] Bomba elétrica

230V~ 50Hz	1200 W
3 bar	64 l/min
H max 48 m	Smax 7 m
1"	8.300 kg
 COLOR BOX	



Art.No	gross weight	in cartoon	barcode
070119	9.500 kg		3800123158353

SELF PRIMING PUMP WITH WATER FILTER AND LCD DISPLAY RDP-WP45

[BG] Помпа водна с воден филтър и LCD дисплей • [RO] Pompa cu autoamorsare • [SR] Pumpa sa filterom za vodu i LCD displejem • [MK] Водна пумпа со филтер за вода и LCD дисплеј • [RU] Насос с водяным фильтром и LCD-дисплеем • [SL] Črpalka za vodo z vodnim filtrom in LCD zaslonom • [EL] Αντλία νερού • [HR] Pumpa za vodu • [FR] Pompe centrifuge • [IT] Pompa centrifuga • [ES] Centrifugaj pumpoj • [PT] Bomba

230V~ 50Hz	1100W
77 l/min	H max 45 m
1"	1 m
2850 min ⁻¹	10.250 kg
Smax 7 m	 COLOR BOX



WITH ELECTRONIC BOOSTER

Art.No	gross weight	in cartoon	barcode
070153	11.130 kg		3800972015791

AUTOMATIC PUMP CONTROLLER RD-EPC02

[BG] Пресостат електронен • [RO] Dispozitiv de comanda electronic • [SR] Kontroler pumpe • [MK] Автоматски контролер на пумпа • [RU] Реле давления воды • [SL] Elektronsko tlačno stikalo • [EL] Ηλεκτρονικός Ελεγκτής Πίεσης Αντλιών • [HR] Tlačna sklopka, elektronička • [FR] Contrôleur de pompe automatique • [IT] Regolatore automatico della pompa • [ES] Automata bombo regilo • [PT] Controlador de bomba automático

230V~ 50Hz
2200 W
Pmax 1 MPa
0.900 kg
 COLOR BOX



Art.No	gross weight	in cartoon	barcode
070127	1.120 kg	12 pcs	3800123161483

GASOLINE WATER PUMP RD-GWP02J

[BG] Помпа водна бензинова • [RO] Motorpompa cu motor pe benzina • [SR] Pumpa za navodnjavanje motorna • [MK] Пумпа за вода на бензин • [RU] Мотопомпа бензиновая • [SL] Bencinska vodna črpalka • [EL] Βενζινοκίνητη αντλία νερού • [HR] Motorna crpka za vodu • [FR] Pompe à eau essence • [IT] Pompa ad acqua benzina • [ES] Bombo por benzino • [PT] Bomba de água a gasolina

25.4 cm ³	8300 W
H max 17.5m	6 500 min ⁻¹
Smax 8 m	1"
ml 700	
133 l/min	l/h 0.7
FUEL / OIL 25:1	8.050 kg



Art.No	gross weight	in cartoon	barcode
079908	8.600 kg		3800123158407

GASOLINE WATER PUMP RD-GWP03J

[BG] Помпа водна бензинова • [RO] Motorpompa cu motor pe benzina • [SR] Pumpa za navodnjavanje motorna • [MK] Пумпа за вода на бензин • [RU] Мотопомпа бензиновая • [SL] Bencinska vodna črpalka • [EL] Βενζινοκίνητη αντλία νερού • [HR] Motorna crpka za vodu • [FR] Pompe à eau essence • [IT] Pompa ad acqua benzina • [ES] Bombo por benzino • [PT] Bomba de água a gasolina

42.7 cm ³	1250 W
H max 35 m	6 500 min⁻¹
S max 8 m	1.5"
ml 1500	
250 l/min	l/h 1
FUEL / OIL 25:1	5.550 kg



Art.No	gross weight	in cartoon	barcode
092101	6.000 kg		3800123161315

GASOLINE WATER PUMP RD-GWP01

[BG] Помпа водна бензинова • [RO] Motorpompa cu motor pe benzina • [SR] Pumpa za navodnjavanje motorna • [MK] Пумпа за вода на бензин • [RU] Мотопомпа бензиновая • [SL] Bencinska vodna črpalka • [EL] Βενζινοκίνητη αντλία νερού • [HR] Motorna crpka za vodu • [FR] Pompe à eau essence • [IT] Pompa ad acqua benzina • [ES] Bombo por benzino • [PT] Bomba de água a gasolina

196 cm ³	4100 W
550 l/min	H max 26 m
S max 8 m	2"
ml 3800	
3 600 min⁻¹	22.100 kg
ml 600	



Art.No	gross weight	in cartoon	barcode
079906	23.000 kg		3800123112980

GASOLINE WATER PUMP RD-GWP04

[BG] Помпа водна бензинова • [RO] Motorpompa cu motor pe benzina • [SR] Pumpa za navodnjavanje motorna • [MK] Пумпа за вода на бензин • [RU] Мотопомпа бензиновая • [SL] Bencinska vodna črpalka • [EL] Βενζινοκίνητη αντλία νερού • [HR] Motorna crpka za vodu • [FR] Pompe à eau essence • [IT] Pompa ad acqua benzina • [ES] Bombo por benzino • [PT] Bomba de água a gasolina

196 cm ³	3"
933 l/min	
S max 8 m	3 600 min⁻¹
ml 3800	l/h 0.6
4900 W	22.700 kg
H max 30 m	



Art.No	gross weight	barcode
070149	24.000 kg	3800972003569

HIGH PRESSURE CLEANER RD-HPC05

[BG] Водоструйка • [RO] Aparat de spalat cu presiune • [SR] Perač pod pritiskom • [MK] Машина за перење под висок притисок • [RU] Мойка высокого давления • [SL] Visokotlačni čistilec • [EL] Πλυντικό υψηλής πίεσης • [HR] Visokotlačni čistač • [FR] Nettoyeur haute pression • [IT] Pulitore ad alta pressione • [ES] Alta premo • [PT] Lavadora

230V~ 50Hz	1400 W
P max 12 MPa	6 l/min
6.400 kg	



Art.No	gross weight	in cartoon	barcode
072103	7.300 kg		3800972009172

HIGH PRESSURE CLEANER RD-HPC01

[BG] Водоструйка • [RO] Aparat de spalat cu presiune • [SR] Perač pod pritiskom • [MK] Машина за перење под висок притисок • [RU] Мойка высокого давления • [SL] Visokotlačni čistilec • [EL] Πλυντικό υψηλής πίεσης • [HR] Visokotlačni čistač • [FR] Nettoyeur haute pression • [IT] Pulitore ad alta pressione • [ES] Alta premo • [PT] Lavadora

230V~ 50Hz	1400 W
P max 10 MPa	5.5 l/min
5.700 kg	



Art.No	gross weight	in cartoon	barcode
123201	6.400 kg		3800123115554

HIGH PRESSURE CLEANER RD-HPC02

[BG] Водоструйка • [RO] Aparat de spalat cu presiune • [SR] Perač pod pritiskom • [MK] Машина за перење под висок притисок • [RU] Мойка высокого давления • [SL] Visokotlačni čistilec • [EL] Πλυντικό υψηλής πίεσης • [HR] Visokotlačni čistač • [FR] Nettoyeur haute pression • [IT] Pulitore ad alta pressione • [ES] Alta premo • [PT] Lavadora

230V~ 50Hz	1800 W
P max 14 MPa	6.7 l/min
5 m	8.900 kg



Art.No	gross weight	in cartoon	barcode
123202	10.060 kg		3800123140938

HIGH PRESSURE CLEANER RD-HPC07

[BG] Водоструйка • [RO] Aparat de spalat cu presiune • [SR] Perač pod pritiskom • [MK] Машина за перење под висок притисок • [RU] Мойка высокого давления • [SL] Visokotlačni čistilec • [EL] Πλυντικό υψηλής πίεσης • [HR] Visokotlačni čistač • [FR] Nettoyeur haute pression • [IT] Pulitore ad alta pressione • [ES] Alta premo • [PT] Lavadora

230V~ 50Hz	2200 W
P _{max} 17 MPa	7.5 l/min
8.200 kg	 COLOR BOX



Art.No	gross weight	in cartoon	barcode
072105	9.500 kg	1pcs	3800972015982

HIGH PRESSURE CLEANER RD-HPC08

[BG] Водоструйка • [RO] Aparat de spalat cu presiune • [SR] Perač pod pritiskom • [MK] Машина за перење под висок притисок • [RU] Мойка высокого давления • [SL] Visokotlačni čistilec • [EL] Πλυντικό υψηλής πίεσης • [HR] Visokotlačni čistač • [FR] Nettoyeur haute pression • [IT] Pulitore ad alta pressione • [ES] Alta premo • [PT] Lavadora

230V~ 50Hz	2500 W
P _{max} 19.5 MPa	7.8 l/min
8.600 kg	 COLOR BOX



Art.No	gross weight	in cartoon	barcode
072106	9.800 kg	1pcs	3800972015999

GASOLINE HIGH PRESSURE CLEANER RD-GHPC06

[BG] Водоструйка • [RO] Aparat de spalat cu presiune • [SR] Perač pod pritiskom • [MK] Машина за перење под висок притисок • [RU] Мойка высокого давления • [SL] Visokotlačni čistilec • [EL] Πλυντικό υψηλής πίεσης • [HR] Visokotlačni čistač • [FR] Nettoyeur haute pression • [IT] Pulitore ad alta pressione • [ES] Alta premo • [PT] Lavadora

230V~ 50Hz	4800 W
P _{max} 20,0 MPa	8,3 l/min
8.600 kg	 COLOR BOX



Art.No	gross weight	in cartoon	barcode
072104	9.800 kg	1pcs	3800972010673

HOSE FOR HIGH PRESSURE CLEANER FOR RD-HPC01,04

[BG] Маркуч за водоструйка • [RO] Furtun pentru spalator cu presiune • [SR] Crevo visokog pritiska za perač • [MK] Црево за машина за перење • [RU] Шланг для мойки высокого давления • [SL] Cev za visokotlačni čistilec • [EL] Αποφρακτικός Σωλήνας Υψηλής Πίεσης • [HR] Visokotlačno crijevo za Visokotlačni čistač • [FR] Tuyau 5m pour les travaux d'eau • [IT] Tubo flessibile 5m per acquedotto • [ES] Hose 5m por akvaj verkoj • [PT] Mangueira 5m para sistema hidráulico



art. №	Bar	Hose lenght	barcode
138101	100	5m	3800123158476

HOSE 8M 200BAR FOR HIGH PRESSURE CLEANER RD-GHPC06

[BG] Маркуч за водоструйка • [RO] Furtun pentru spalator cu presiune • [SR] Crevo visokog pritiska za perač • [MK] Црево за машина за перење • [RU] Шланг для мойки высокого давления • [SL] Cev za visokotlačni čistilec • [EL] Αποφρακτικός Σωλήνας Υψηλής Πίεσης • [HR] Visokotlačno crijevo za Visokotlačni čistač • [FR] Tuyau 5m pour les travaux d'eau • [IT] Tubo flessibile 5m per acquedotto • [ES] Hose 5m por akvaj verkoj • [PT] Mangueira 5m para sistema hidráulico



art. №	Bar	Hose lenght	barcode
138122	200	8m	3800972019300

HOSE FOR HIGH PRESSURE CLEANER

[BG] Маркуч за водоструйка • [RO] Furtun pentru spalator cu presiune • [SR] Crevo visokog pritiska za perač • [MK] Црево за машина за перење • [RU] Шланг для мойки высокого давления • [SL] Cev za visokotlačni čistilec • [EL] Αποφρακτικός Σωλήνας Υψηλής Πίεσης • [HR] Visokotlačno crijevo za Visokotlačni čistač • [FR] Tuyau 5m pour les travaux d'eau • [IT] Tubo flessibile 5m per acquedotto • [ES] Hose 5m por akvaj verkoj • [PT] Mangueira 5m para sistema hidráulico



art. №	Bar	Hose lenght	barcode
139962 for RD-HPC02	140	8m	3800123115813
138121 for RD-HPC07,08	200	8m	3800972016040
138113 for RD-HPC05	120	6m	3800972009974

GUN FOR HIGH PRESSURE CLEANER

[BG] Пистолет за водоструйка • [RO] Pistol pentru aparat de spalat cu presiune • [SR] Pištolj za perač • [MK] Пиштол за машина за перенье • [RU] Пистолет для мойки высокого давления • [SL] Pištola za pranje • [EL] Πιστόλι για πλυντικό υψηλής πίεσης • [HR] Pištolj za Visoktlačni čistač • [FR] Arme à feu • [IT] Pistola • [ES] Pafilo • [PT] Pistola de ar



PAPER CARD

art. №	barcode	art. №	barcode
139960 for RD-HPC01,04	3800123115790	138117 for RD-HPC07,08	3800972016002
		138102 for RD-HPC02	3800123158483
		138114 for RD-HPC05	3800972009981

DETERGENT TANK FOR HIGH PRESSURE CLEANER



PAPER CARD

art. №	barcode
138120 for RD-HPC07,08	3800972016033
138104 for RD-HPC01,02,04	3800123158506
138115 for RD-HPC05	3800972009998

DETERGENT TANK FOR HIGH PRESSURE CLEANER



art. №	barcode
138119 for RD-HPC07,08	3800972016026
138105 for RD-HPC01,02,04	3800123158513

CONNECTOR FOR ROTARY BRUSH KIT FOR HIGH PRESSURE CLEANERS RD-HPC07&08



art. №	barcode
138124	3800972022652

METAL MINI AIR COMPRESSOR RD-AC05

[BG] Компресор метален с аксесоари • [RO] Mini Compresor • [SR] Kompresor zaduvanje guma • [MK] Компресорче • [RU] Компрессор для накачивания шин • [SL] Avtomobilski kompresor • [EL] Αεροσυμπιεστής • [HR] Kompresor • [FR] Compresseur de gonflage • [IT] Compresore per gonfiaggio pneumatici • [ES] Kompresoro pri švelaja inflacio • [PT] Compressor de inflação de pneus

12 V	120 W
35 L/min	P 0.96 Pa
3m	1 m
1.670 kg	COLOR BOX



Art.No	gross weight	in cartoon	barcode
089402	1.700 kg	10 pcs	3800123174537

LANCE GUN FOR HIGH PRESSURE CLEANER RD-HPC05

[BG] Пистолет за водоструйка • [RO] Pistol pentru aparat de spalat cu presiune • [SR] Pištolj za perač • [MK] Пиштол за машина за перенье • [RU] Пистолет для мойки высокого давления • [SL] Pištola za pranje • [EL] Πιστόλι για πλυντικό υψηλής πίεσης • [HR] Pištolj za Visoktlačni čistač • [FR] Arme à feu • [IT] Pistola • [ES] Pafilo • [PT] Pistola de ar



art. №	barcode
138123	3800972019317

LANCE GUN FOR HIGH PRESSURE CLEANER

[BG] Накрайник за пистолет на водоструйка • [RO] Lance pentru pistol aparat de spalat cu presiune • [SR] Nastavak visokog pritiska za perač • [MK] Спojка за машина за перенье • [RU] Струйная насадка • [SL] Razpršilna šoba za visokotlačni čistilec • [EL] Προεκταση κανης • [HR] Rotacijska mlaznica za Visoktlačni čistač • [FR] Pointe de pistolet hydraulique • [IT] Punta della pistola a pistola idraulica • [ES] Hidraülilka pafilo • [PT] Ponta da pistola hidráulica



PAPER CARD

art. №	barcode
139961 for RD-HPC01,02,04	3800123115806
138116 for RD-HPC05	3800972010000



PAPER CARD

art. №	barcode
138118 for RD-HPC07,08	3800972016019
138103 for RD-HPC01,02,04	3800123158490

METAL MINI AIR COMPRESSOR RD-AC13

[BG] Компресор метален с аксесоари • [RO] Mini Compresor • [SR] Kompresor zaduvanje guma • [MK] Компресорче • [RU] Компрессор для накачивания шин • [SL] Avtomobilski kompresor • [EL] Αεροσυμπιεστής • [HR] Kompresor • [FR] Compresseur de gonflage • [IT] Compresore per gonfiaggio pneumatici • [ES] Kompresoro pri švelaja inflacio • [PT] Compressor de inflação de pneus

12 V	180 W
35 L/min	P 0.96 Pa
1 m	1.600 kg
COLOR BOX	



Art.No	gross weight	in cartoon	barcode
089408	1.700 kg	10 pcs	3800972016397

METAL MINI AIR COMPRESSOR RD-AC14

[BG] Компресор метален с аксесоари • [RO] Mini Compresor • [SR] Kompresor zaduvanje guma • [MK] Компресорче • [RU] Компрессор для накачивания шин • [SL] Avtomobilski kompresor • [EL] Αεροσυμπιεστής • [HR] Kompresor • [FR] Compresseur de gonflage • [IT] Compresore per gonfiaggio pneumatici • [ES] Kompresoro pri švelaja inflacio • [PT] Compressor de inflação de pneus

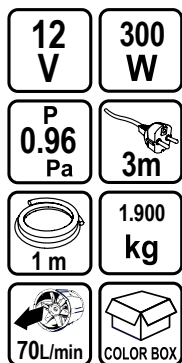

Art.No	gross weight	in cartoon	barcode
089409	3.670 kg	6 pcs	3800972016408

AIR COMPRESSOR RD-AC040

[BG] Компресор • [RO] Compresor • [SR] Kompresor • [MK] Компресор • [RU] Компрессор • [SL] Kompresor [EL] Συμπιεστής • [HR] Kompresor • [FR] Compresseur • [IT] Compresore • [ES] Kompresoro [PT] Compressor



Art.No	gross weight	barcode
089401	19.000 kg	3800123173462

METAL MINI AIR COMPRESSOR RD-AC12

[BG] Компресор метален с аксесоари • [RO] Mini Compresor • [SR] Kompresor zaduvanje guma • [MK] Компресорче • [RU] Компрессор для накачивания шин • [SL] Avtomobilski kompresor • [EL] Αεροσυμπιεστής • [HR] Kompresor • [FR] Compresseur de gonflage • [IT] Compresore per gonfiaggio pneumatici • [ES] Kompresoro pri švelaja inflacio • [PT] Compressor de inflação de pneus

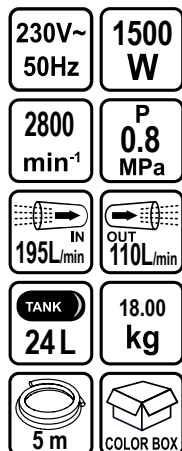

Art.No	gross weight	barcode
089407	19.000 kg	3800972016071

QUIET OIL FREE AIR COMPRESSOR RD-AC07

[BG] Компресор тих безмаслен • [RO] Compresor • [SR] Kompresor • [MK] Компресор • [RU] Компрессор • [SL] Kompresor [EL] Συμπιεστής • [HR] Kompresor • [FR] Compresseur • [IT] Compresore • [ES] Kompresoro • [PT] Compressor

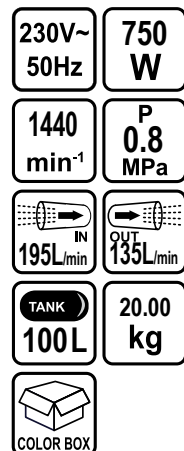

Art.No	gross weight	barcode
089405	21.000 kg	3800972009639

AIR COMPRESSOR RD-AC02

[BG] Компресор • [RO] Compresor • [SR] Kompresor • [MK] Компресор • [RU] Компрессор • [SL] Kompresor [EL] Συμπιεστής • [HR] Kompresor • [FR] Compresseur • [IT] Compresore • [ES] Kompresoro • [PT] Compressor

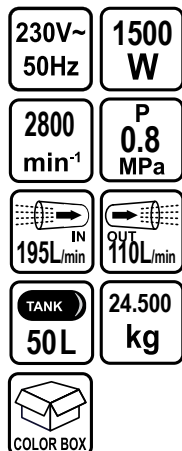

Art.No	gross weight	barcode
120105	25.000 kg	3800123123368

AIR COMPRESSOR RD-AC08

[BG] Компресор • [RO] Compresor • [SR] Kompresor • [MK] Компресор • [RU] Компрессор • [SL] Kompresor [EL] Συμπιεστής • [HR] Kompresor • [FR] Compresseur • [IT] Compresore • [ES] Kompresoro • [PT] Compressor



Art.No	gross weight	barcode
089406	32.000 kg	3800972009646

AIR COMPRESSOR RD-AC030

[BG] Компресор • [RO] Compresor • [SR] Kompresor • [MK] Компресор • [RU] Компрессор
 • [SL] Kompresor [EL] Συμπιεστής • [HR] Kompresor • [FR] Compresseur • [IT] Compresore
 • [ES] Kompresoro • [PT] Compressor

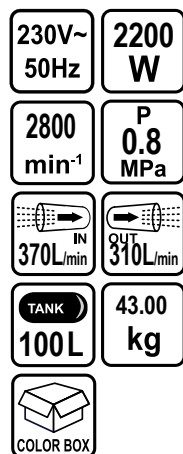

Art.No	gross weight	barcode
120107	45.920 kg	3800123160820

AIR COMPRESSOR RD-AC06

[BG] Компресор • [RO] Compresor • [SR] Kompresor • [MK] Компресор • [RU] Компрессор
 • [SL] Kompresor [EL] Συμπιεστής • [HR] Kompresor • [FR] Compresseur • [IT] Compresore
 • [ES] Kompresoro • [PT] Compressor



Art.No	gross weight	barcode
089404	220 kg	3800123174735

AIR DRILL RD-AD02

• [BG] Бормашина пневматична • [RO] Masina de gaurit pneumatica • [SR] Bušilica pneumatska
 • [MK] Бормашина пневматска • [RU] Пневматическая Дрель • [SL] Pnevmatiskih vrtalnik • [EL]
 Δράπανο Αέρος [HR] Pnevmatiska Bušilica • [FR] Perceuse à air • [IT] Trapano pneumatico • [ES]
 Aera Drilo • [PT] Aparafusadora pneumáticas

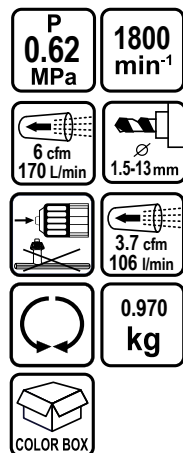

Art.No	gross weight	in cartoon	barcode
080103	1.370 kg	10 pcs	3800123123689

AIR ANGLE GRINDER RD-AAG03

• [BG] Ъглошлайф пневматичен • [RO] Polizor unghiular pneumatic • [SR] Brusilica ugaona
 pneumatica • [MK] Брусилка пневматска [RU] Пневматический шлифовальный станок • [SL]
 Pnevmatiski brusilnik • [EL] Γωνιακός αεροτροχός • [HR] Kutna brusilica • [FR] Meuleuse d'angle
 d'air • [IT] Air Angle Grinder • [ES] Aera Angulo Muellilo • [PT] Rebarbadora pneumáticas

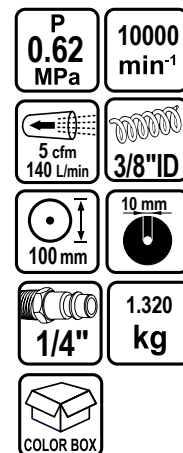

Art.No	gross weight	in cartoon	barcode
089939	1.340 kg	10 pcs	3800123153648

CUTTING DISC FOR METAL

[BG] Диск за метал • [RO] Disc pentru metal • [SR] Rezna ploča za metal • [MK] Брус камен за
 метал [RU] Диск для резки металла • [SL] Rezanje plošče • [EL] Δίσκοι κοπής μετάλλων •
 [HR] Ploče za rezanje metala • [FR] Disque de coupe pour métal • [IT] Disco da taglio per metallo •
 [ES] Trancha disco por metalo maniko • [PT] Trancha Disko por metalo



art. No	Ø (mm)	Ø ₁ (mm)	D (mm)	barcode
169904	100	16	1.0	3800123143731
169902	100	16	3.0	3800123141928
169903	100	16	6.0	3800123141935
169901	75	9.5	1.6	3800123122514

AIR CUT OFF TOOL RD-AC11

• [BG] Резачка пневматична • [RO] Masina de taiat pneumatica • [SR] Brusilica ugaona pneumatica
 • [MK] Мини брусилка пневматска [RU] Пневматическая Угловая Шлифовальная машина
 • [SL] Pnev vmatiski Kotni Brusilnik • [EL] Γωνιακός Τροχός Αέρος • [HR] Pnevmatiska rezačica •
 [FR] Outil de coupeure d'air • [IT] Strumento di taglio pneumatico • [ES] Aero tranchita ekstere • [PT]
 Cortadora pneumática/ disco



Art.No	gross weight	in cartoon	barcode
089921	1.060 kg	20 pcs	3800123122415

AIR RANDOM ORBIT SANDER RD-AROS01

• [BG] Ексцентършлайф пневматичен • [RO] Slefuitor orbital pneumatic • [SR] Brusilica Rotaciona pneumatska • [МК] Пневматска Ексцентрична Брусилка • [RU] Пневматичекий Эксцентрикковые шлифовальные машины • [SL] Pnevmatiskih Ekscentrični Brusilnik • [EL] Αέρος Εκκεντρο Τριβείο • [HR] Brusilica Ekscentarska • [FR] Ponceuse orbitale Air Random • [IT] Levigatrice orbitale • [ES] Orbital Sander • [PT] Lixadora orbital pneumática

P 0.62 MPa	10000 min ⁻¹
2.8 cfm 79.2 L/min	3/8" ID
Ø 150 mm	1/4"
DUST CAPTURE ПРАХО-УЛАВЯНЕ	1.300 kg
COLOR BOX	



Art.No	gross weight	in cartoon	barcode
089301	1.560 kg	10 pcs	3800123165375

AIR HAMMER MINI RD-AH01

• [BG] Секач пневматичен • [RO] Dalta pneumatica • [SR] Čekić bušilica pneumatski • [МК] Ударен Чекан пневматски • [RU] Пневматическое зубило • [SL] Pnevmatisko udarno dleto • [EL] Αεροσφύρα • [HR] Pnevmatiski Čekić • [FR] Marteau Mini • [IT] Aero Martelo • [ES] Aera martelo • [PT] Kit mini-martelo pneumático

P 0.62 MPa	2.8 cfm 79.2 L/min
3500 min ⁻¹	3/8" ID
1/4"	1.180 kg
10.2 mm	COLOR BOX



Art.No	gross weight	in cartoon	barcode
080102	1.760 kg	10 pcs	3800123123672

AIR MICRO GRINDER RD-AMG01

• [BG] Шлифовалка пневматична микро • [RO] Polizor drept pneumatic • [SR] Brusilica беопа pneumatska • [МК] Пневматска Шлајферица • [RU] Шлифовальный станок мини • [SL] Zracni Mini Brusilnik • [EL] Μίνι Τροχέιο αέρος • [HR] Jednoročna Brusilica Mini • [FR] Appareil à mouder • [IT] Aero molare • [ES] Muelillo • [PT] Moedor

P 0.62 MPa	56 000 min ⁻¹
2 cfm 57 L/min	3 mm
1/4"	0.210 kg
	COLOR BOX



Art.No	gross weight	in cartoon	barcode
089920	0.330 kg	20 pcs	3800123122675

AIR DIE GRINDER RD-ADG01

• [BG] Шлифовалка пневматична права • [RO] Polizor drept pneumatic • [SR] Brusilica беопа pneumatska • [МК] Пневматска Шлајферица • [RU] Шлифовальный станок мини • [SL] Zracni Mini Brusilnik • [EL] Μίνι Τροχέιο αέρος • [HR] Jednoročna Brusilica • [FR] Broyeur d'air • [IT] Aero Macinino • [ES] Aera Muelillo • [PT] Moedor de ar

P 0.62 MPa	4.5 cfm 128 L/min
22 000 min ⁻¹	3/8" ID
6 mm	0.645 kg
1/4"	COLOR BOX



Art.No	gross weight	in cartoon	barcode
081102	0.680 kg	20 pcs	3800123123696

AIR ANGLE DIE GRINDER RD-AADG06

• [BG] Шлифовалка пневматична под прав ъгъл • [RO] Polizor drept pneumatic • [SR] Brusilica беопа pneumatska • [МК] Пневматска Шлајферица • [RU] Шлифовальный станок мини • [SL] Zracni Mini Brusilnik • [EL] Μίνι Τροχέιο αέρος • [HR] Jednoročna Brusilica • [FR] Meuleuse d'angle d'air • [IT] Macinino • [ES] Aera Angulo Muelillo • [PT] Rebarbadora pneumática

P 0.62 MPa	20 000 min ⁻¹
2.2 cfm 62.7 L/min	6 mm
1/4"	0.500 kg
	COLOR BOX



Art.No	gross weight	in cartoon	barcode
089924	0.690 kg	20 pcs	3800123122446

AIR RATCHET WRENCH RD-ARO1

• [BG] Тресчотка пневматична • [RO] Cheie cu clichet pneumatica • [SR] Račna Pnevmatiska • [МК] Пневматска крцкалка • [RU] Трещотка пневматическая • [SL] Zracni ratchet klijucem • [EL] Καστόνια αέρος • [HR] Pnevmatiska Račna • [FR] Clé à cliquet pneumatique • [IT] Chiave a cricchetto pneumatico • [ES] Slosilo de aera raketo • [PT] Chave de roquete pneumática

P 0.62 MPa	113 L/min
160 min ⁻¹	1/2" inch
68 Nm	1.210 kg
	COLOR BOX



Art.No	gross weight	in cartoon	barcode
089905	1.360 kg	20 pcs	3800123123702

AIR IMPACT WRENCH RD-AW03

• [BG] Гайковерт пневматичен ударен • [RO] Cheie cu impact pneumatica • [SR] Zavrtač set pneumatski • [MK] Пневматски чекан навртувачот • [RU] Пневматический ударный гайковерт • [SL] Nárazový ključ [EL] Κρουστικό κλειδί • [HR] Udarni Izvijač • [FR] Clé à chocs pneumatique • [IT] Chiave pneumatica • [ES] Aera Trancilo • [PT] Chave de impacto pneumática

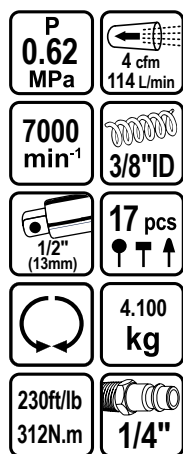

Art.No	gross weight	in cartoon	barcode
089922	4.390 kg	4 pcs	3800123122422

AIR IMPACT WRENCH RD-AW04

• [BG] Гайковерт пневматичен ударен • [RO] Cheie cu impact pneumatica • [SR] Zavrtač set pneumatski • [MK] Пневматски чекан навртувачот • [RU] Пневматический ударный гайковерт • [SL] Nárazový ključ [EL] Κρουστικό κλειδί • [HR] Udarni Izvijač • [FR] Clé à chocs pneumatique • [IT] Chiave pneumatica • [ES] Aera Trancilo • [PT] Chave de impacto pneumática



Art.No	gross weight	in cartoon	barcode
089940	6.800 kg	2 pcs	3800123153655

COMBINED AIR STAPLER AND NAILER RD-AS04

[BG] Такер пневматичен комбиниран • [RO] Capsator pneumatic combi • [SR] Heftalica pneumatica • [MK] Хефталлица пневматска [RU] Пневматический степлер • [SL] Pnevmatiski spenjač • [EL] Συρραπτικό Πεπιεσμένου Αέρα • [HR] Pneumatska Klamerica • [FR] Agrafeuse à air • [IT] Cucitrice ad aria • [ES] Aera Stelo • [PT] Agrafador pneumático

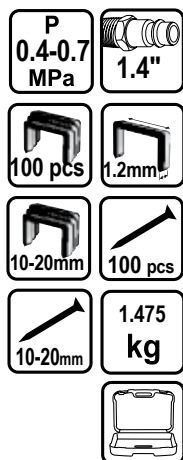

Art.No	gross weight	in cartoon	barcode
088102	1.520	10	3800972009141

STAPLES FOR RD-AS03, RD-AS04

[BG] Скоби за пневматичен такер • [RO] Set capse pentru • [SR] Klamerice za pneumatsku heftalica • [MK] Муниција за хефталка • [RU] Скобы для пневматического степлера • [SL] Sponke • [EL] Συνοχεύς για συρραπτικά • [HR] Klamerice za pneumatska klamerica • [FR] Agrafes pour agrafeuse pneumatique • [IT] Graffette per cucitrice pneumatica • [ES] Staples por pneumática stapilo • [PT] Grampos para grampeador pneumático



art. №	H (mm)	W (mm)	D (mm)	Pcs	BARCODE
511407	10	10	1.2	5000	3800972010338
511408	12	10	1.2	5000	3800972010345
511409	14	10	1.2	5000	3800972010352
511410	16	10	1.2	5000	3800972010369
511411	20	10	1.2	5000	3800972010376

AIR STAPLER RD-AS01

[BG] Такер пневматичен • [RO] Capsator pneumatic • [SR] Heftalica pneumatica • [MK] Хефталлица пневматска [RU] Пневматический степлер [SL] Pnevmatiski spenjač • [EL] Συρραπτικό Πεπιεσμένου Αέρα • [HR] Pneumatska Klamerica • [FR] Agrafeuse à air • [IT] Cucitrice ad aria • [ES] Aera Stelo • [PT] Agrafador pneumático

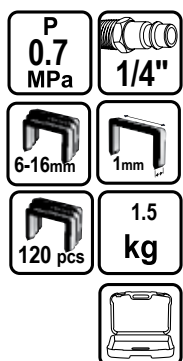

Art.No	gross weight	in cartoon	barcode
089908	2.0 kg	10	3800123123146

STAPLES FOR RD-AS01

• [BG] Скоби за пневматичен такер • [RO] Set capse • [SR] Klamerice za pneumatsku heftalica • [MK] Муниција за хефталка • [RU] Скобы для пневматического степлера • [SL] Sponke • [EL] Συνοχεύς για συρραπτικά • [HR] Klamerice za pneumatska klamerica • [FR] Sauterelles pneumatiques • [IT] Morsetti di inclinazione pneumatici • [ES] Pneuñmaj tiltaj abrazoj • [PT] Grampos pneumáticos de inclinação



5000 PCS

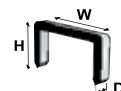

art. №	H (mm)	W (mm)	D (mm)	BARCODE
511300	6	12.8	1	3800123104831
511308	8	12.8	1	3800123122248
511309	10	12.8	1	3800123122255
511310	12	12.8	1	3800123122262
511311	14	12.8	1	3800123122279
511312	16	12.8	1	3800123122286

AIR STAPLER RD-AS03

[BG] Такер пневматичен • [RO] Capsator pneumatic • [SR] Heftalica pneumatica
 • [MK] Хефталица пнеувматска [RU] Пневматический степлер [SL] Pnevmatiski spenjač
 • [EL] Συρραπτικό Πνευματικού Αέρα • [HR] Pnevmatiska Klamerica • [FR] Agrafeuse à air
 • [IT] Cucitrice ad aria • [ES] Aera Stelo • [PT] Agrafador pneumático



Art.No	gross weight	in cartoon	barcode
088101	2.0 kg	10	3800972002326

STAPLES FOR RD-AS03, RD-AS04

[BG] Скоби за пневматичен такер • [RO] Set capse pentru • [SR] Klamerice za pneumaticu heftalicu
 • [MK] Муниција за хефталица • [RU] Скобы для пневматического степлера • [SL] Sponke
 • [EL] Συνοχούς για συρραπτικά • [HR] Klamerice za pneumatica klamerica • [FR] Agrafes
 pour agrafeuse pneumatique • [IT] Graffette per cucitrice pneumatica • [ES] Staples por pneumática
 stapilo • [PT] Grampos para grampeador pneumático



COLOR BOX



art. №	H (mm)	W (mm)	D (mm)	Pcs	BARCODE
511401	6	9.1	0.7	10000	3800972002340
511402	8	9.1	0.7	10000	3800972002357
511403	10	9.1	0.7	10000	3800972002364
511404	12	9.1	0.7	10000	3800972002371
511405	14	9.1	0.7	10000	3800972002388
511406	16	9.1	0.7	10000	3800972002395

COMBINED AIR STAPLER AND NAILER RD-AS02

[BG] Такер пневматичен комбиниран • [RO] Capsator pneumatic combi • [SR] Heftalica pneumatica
 • [MK] Хефталица пнеувматска [RU] Пневматический степлер • [SL] Pnevmatiski spenjač
 • [EL] Συρραπτικό Πνευματικού Αέρα • [HR] Pnevmatiska Klamerica • [FR] Agrafeuse à air
 • [IT] Cucitrice ad aria • [ES] Aera Stelo • [PT] Agrafador pneumático

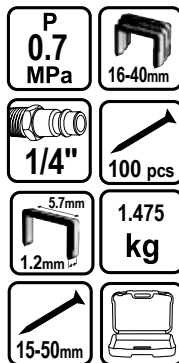

Art.No	gross weight	in cartoon	barcode
089923	2.560	10	3800123122439

STAPLES FOR RD-AS02

[BG] Скоби за пневматичен такер • [RO] Set capse • [SR] Klamerice za pneumaticu heftalicu
 • [MK] Муниција за хефталица • [RU] Скобы для пневматического степлера • [SL] Žebelj
 • [EL] Συνοχούς για συρραπτικά • [HR] Klamerice za pneumatica klamerica • [FR] Sauterelles
 pneumatiques • [IT] Morsetti di inclinazione pneumatici • [ES] Pneuñmaj tiltaj abrazjo • [PT] Grampos
 pneumáticos de inclinação



COLOR BOX

5000 PCS



art. №	H (mm)	W (mm)	D (mm)	BARCODE
511330	16	5.7	1.2	3800123139710
511317	25	5.7	1.2	3800123122521
511318	32	5.7	1.2	3800123122538
511350	40	5.7	1.2	3800123171574

NAILS FOR RD-AS02

[BG] Пирони за пневматичен такер • [RO] Set capse pentru [SR] Klamerice za pneumaticu heftalicu
 • [MK] Муниција за хефталица • [RU] Скобы для пневматического степлера
 • [SL] Sponke • [EL] Συνοχούς για συρραπτικά • [HR] Klamerice za pneumatica klamerica
 • [FR] Sauterelles pneumatiques • [IT] Morsetti di inclinazione pneumatici • [ES] Pneuñmaj tiltaj abrazjo
 • [PT] Grampos pneumáticos de inclinação



COLOR BOX

5000 PCS



art. №	H (mm)	D (mm)	BARCODE
511313	15	1	3800123122293
511314	25	1	3800123122309
511315	35	1	3800123122316
511316	45	1	3800123122323

SANDBLASTING GUN SET RD-SBG01

[BG] Пистолет пясъкоструен с аксесоари • [RO] Pistol de sablat • [SR] Pištolj za piskarenje
 • [MK] Пиштол За Млаз • [RU] Пистолет для струйной обработки • [SL] Pištola Za Peskanje
 • [EL] Πιστόλι Ακτινοβόλησης • [HR] Pištolj za piskarenje • [FR] Set de pistolet de sablage
 • [IT] Set di pistole per sabbatura • [ES] Sandblasting Pafilo • [PT] Pistola p/ lixar



Art.No	gross weight	in cartoon	barcode
089942	2.080	10	3800123165382

SILICONE CARBIDE SAND FOR SANDBLASTING

[BG] Пясък абразивен за пясъкоструен пистолет • [RO] Nisip carbură de siliciu • [SR] Abrazivni pesok
 • [MK] Песок абразивен • [RU] Порошок абразивный • [SL] Bakrova žindra
 • [EL] Λειαντικές άμμος • [HR] Brusni pijesak • [FR] Sable abrasif pour un pistolet de sablage
 • [IT] Sabbia abrasiva per una pistola di sabbatura • [ES] Abrasiva sablo por sandblast pafilo
 • [PT] Areia abrasiva para uma pistola de jato de areia



art. №	kg	barcode
160151	1	3800123166655



PAPER CARD

AIR DUSTER GUN

[BG] Пистолет за въздух • [RO] Pistol cu aer • [SR] Pištolj za izduvavanje pneumatski • [MK] Пиштол за воздух [RU] Пистолет продувочный • [SL] Pnevmatška pištola • [EL] Πιστόλι αέρος • [HR] Pištolj Za Ispuhivanje • [FR] Pistolet à air comprimé • [IT] Spolverino aria pistola • [ES] Armilo de aero • [PT] Pistola ar comprimido

1/4"

3/8"ID

**0.155
kg**

BLISTER

80 mm
30 mm

Art.No	gross weight	in cartoon	barcode
089802	0.170	100	3800123165382

AIR DUSTER GUN WITH AIR PU SPIRAL HOSE 5M WITH QUICK COUPLINGS 1/4" M&F RD-DG03

[BG] Пистолет за въздух • [RO] Pistol cu aer • [SR] Pištolj za izduvavanje pneumatski • [MK] Пиштол за воздух [RU] Пистолет продувочный • [SL] Pnevmatška pištola • [EL] Πιστόλι αέρος • [HR] Pištolj Za Ispuhivanje • [FR] Pistolet à air comprimé • [IT] Spolverino aria pistola • [ES] Armilo de aero • [PT] Pistola ar comprimido



Art.No	gross weight	in cartoon	barcode
089803	0.170	100	3800972022843

AIR CLEANING GUN RD-CG01

[BG] Пистолет за почистване с долно казанче • [RO] Pistol cu tija si rezervor • [SR] Pištolj za izduvavanje pneumaticki • [MK] Пиштол за чистење со долно казанче • [RU] Пистолет продувочный • [SL] Pnevmatška pištola • [EL] Πιστόλι αέρος • [HR] Pištolj za Ispuhivanje • [FR] Pistolet de nettoyage d'air • [IT] Pistola per la pulizia dell'aria • [ES] Aera purigado pafilo • [PT] Pistola ar comprimido

1/4"

3/8"ID

800ml

**0.510
kg**

BLISTER

Art.No	gross weight	in cartoon	barcode
089916	0.660	10	3800123122408

PISTOL-GRIP AIR INFLATOR WITH GAUGE RD-TI01

[BG] Пистолет за гуми с манометър • [RO] Manometru • [SR] Pištolj za duvanje guma • [MK] Пиштол за пумпање са манометар • [RU] Пистолет для накачки • [SL] Pištola za polnjenje pneumaticki • [EL] Αεροπίστολο Πλήρωσης Αέρα με Μανόμετρο • [HR] Pištolj sa manometrom • [FR] Gonfleur pistol-grip air avec jauge • [IT] Gonfiatore ad aria compressa con manometro • [ES] Pistol-grip air inflator kun gauge • [PT] Pistola ar comprimido c/ manómetro

1/4"

3/8"ID

**0.420
kg**

BLISTER

Art.No	gross weight	in cartoon	barcode
089904	0.420	40	3800123137075

PLUG FOR HOSE OF INFLATING GUN

[BG] Накрайник за помпана на гуми за маркуч • [RO] Mufă furtun pentru pistol aer • [SR] Spojnic za crevo za pištolja naduvavanje • [MK] Спојка за crevo за пумпање на гуми • [RU] Насадка для накачивания шин шланга [SL] Sklopke • [EL] Σύνδεσμος, αρσενικό μέρος • [HR] Spojnice za naruhanje guma za crijeva • [FR] Buse pour gonfler les pneus du tuyau • [IT] Ugello per gonfiare le gomme del tubo • [ES] Borrillo por inflakti la pneuojn de la maniko • [PT] Bocal para inflar os pneus da mangueira



BLISTER

6 mm

Art.No	barcode
110906	3800123159435

AIR BRUSH 7 PCS KIT RD-AB02

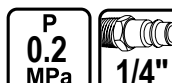
[BG] Аерограф еднодействиащ 7 части • [RO] Aerograf • [SR] Set paintbrush pistolj za farbanje • [MK] Комплет за фарбање 7 ком. • [RU] Наносить краску распылителем • [SL] Zračni čopič • [EL] Σετ αερογράφου • [HR] Zračni Kist 7 dijelova • [FR] Kit de brosse à air 7pcs • [IT] Spazzola ad ariaKit 7 pezzi • [ES] Aera Broso 7pcs Kit • [PT] Kit pintura ar comprimido

**P
0.2
MPa**

1/4"

Ø 0.5mm

60 ml
1.6 m

**0.360
kg**

BLISTER

Art.No	gross weight	in cartoon	barcode
089936	0.520	20	3800123153389

AIR BRUSH PUSH-BUTTON DOUBLE FUNCTION 8 PCS KIT RD-AB01

[BG] Аерограф двойнойдействац 8 части • [RO] Aerograf • [SR] Set paintbrush pistolj za farbanje • [MK] Комплет за фарбање 8 ком • [RU] Наносить краску распылителем • [SL] Zračni čopič • [EL] Σετ αερογράφου • [HR] Zračni Kist 8 dijelova • [FR] Bouton poussoir double fonction Air Brush 8 pcs • [IT] Pulsante a spazzola d'aria a doppia funzione 8 pz • [ES] Air Brush Push-button Duobla Funkcio 8 komputiloj • [PT] Kit pintura ar comprimido



Art.No	gross weight	in cartoon	barcode
089935	0.490	20	3800123153327

AIR SPRAY GUN FOR POLYURETANE INSULATION RD-PUSG13

[BG] Пистолет за полиуретан • [RO] Pistol de aerisire pentru izolație din poliuretana • [SR] Pištolj za raspršivanje vazduha za izolaciju od poliuretana • [MK] Пневматски распрснучач за полиуретанска изолација • [RU] Воздушный распылитель для полиуретановой изоляции • [SL] Pištola za brizganje zraka za izolaciju iz poliuretana • [EL] Αεροβόλο όπλο για μόνωση πολυουρεθάνης • [HR] Puhala za raspršivanje zraka za poliuretansku izolaciju • [FR] Pistolet pneumatique pour isolation en polyuréthane • [IT] Pistola a spruzzo pneumatica • [ES] Pistola pulverizadora de aire para aislamiento de poliuretano • [PT] Pistola pneumática p/ projeção de isolamento poliuretano

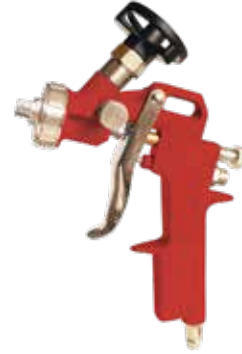
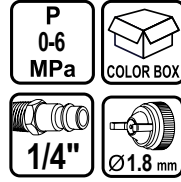

Art.No	gross weight	in cartoon	barcode
089944	0.470	20	3800972010215

AIR GUN GRAVITY RD-SG02

[BG] Пистолет за боя с горно казанче • [RO] Pistol pentru vopsit • [SR] Pištolj za farbanje pneumatski • [MK] Пиштол за фарбање • [RU] Краскопульт • [SL] Brizgalna pištola • [EL] Πιστολι βαφης • [HR] Pištolj za boju • [FR] Bouton poussoir double fonction air brush • [IT] Pulsante a spazzola d'aria a doppia funzione • [ES] Air brush push-button duobla funkcio • [PT] Pistola de pintura c/ copo



Art.No	gross weight	in cartoon	barcode
089909	0.600	20	3800123123177

SPRAY GUN GRAVITY RD-SG05

[BG] Пистолет за боя с горно казанче • [RO] Pistol pentru vopsit • [SR] Pištolj za farbanje pneumatski • [MK] Пиштол за фарбање • [RU] Краскопульт • [SL] Brizgalna pištola • [EL] Πιστολι βαφης • [HR] Pištolj za boju • [FR] Bouton poussoir double fonction air brush • [IT] Pulsante a spazzola d'aria a doppia funzione • [ES] Air brush push-button duobla funkcio • [PT] Pistola de pintura c/ copo

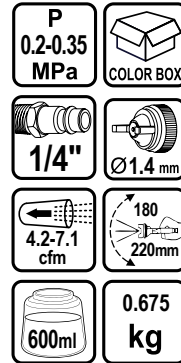

Art.No	gross weight	in cartoon	barcode
089934	0.920	20	3800123152238

CUP FOR RD-SG05

[BG] Казанче за боджийски пистолет RD-SG05 • [RO] Rezervor pentru pistol de vopsit • [SR] Plastično lonče za pištolj za farbanje • [MK] Пластичен сад за спреј пиштол • [RU] Бак нейлоновый для краскопультa • [SL] Dozimni lonček • [EL] Άνω δοχείο PVC πιστολιών βαφης • [HR] Plastično lonče za pištolj za boju • [FR] Atelier de peinture pour la peinture au pistolet • [IT] Negozio di vernici per verniciatura a pistola • [ES] Paint-vendejo por pafotrapo • [PT] Loja de pintura para pintura de armas



art. No	ml (capacity)	barcode
110912 for RD-SG05	600	3800123173073

NOZZLE, NEEDLE & AIR CAP SET

[BG] Дюза, игла и капачка за боджийски пистолет • [RO] Set duza pentru pistol de vopsit • [SR] Dizna za pn. Pištolj za farbanje • [MK] Резервни прожалки - диза, игла и капа за пиштол за фарбање • [RU] Набор дополнительных сопел (воздушная голова, красочное сопло и игла) для краскопультa • [SL] Šoba za lakirne pištole • [EL] Βελώνα, ακροφύσιο & πώμα αέρος • [HR] Maznica za raspršivanje boje set • [FR] Bouchon de buse, aiguille et pistolet à peinture • [IT] Ugello, ago e cappuccio della pistola di vernice • [ES] Nozzle, nadlo kaj pentri pafilon čapo • [PT] Bocal, agulha e tampa de pistola de pintura



art. No	NOZZLE	BARCODE
110907 for RD-SG04	Ø1.5 mm	3800123165399
110909 for RD-SG05	Ø1.2 mm	3800123173042
110908 for RD-SG05	Ø1.4 mm	3800123165405
110910 for RD-SG05	Ø1.8 mm	3800123173059
110911 for RD-SG05	Ø2.0 mm	3800123173066



SPRAY GUN GRAVITY RD-SG04

[BG] Пистолет за боя с горно казанче • [RO] Pistol pentru vopsit • [SR] Pištolj za farbanje pneumatski • [MK] Пиштол за фарбање • [RU] Краскопулт • [SL] Brizgalna pištola • [EL] Πιστολι βαφης • [HR] Pištolj za boju • [FR] Bouton poussoir double fonction air brush • [IT] Pulsante a spazzola d'aria a doppia funzione • [ES] Air brush push-button duobla funkcio • [PT] Pistola de pintura c/ copo

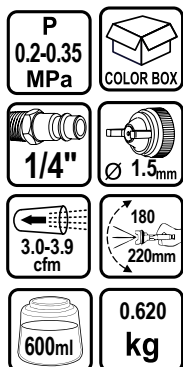

Art.No	gross weight	in cartoon	barcode
089933	1.100	10	3800123152221

SPRAY GUN GRAVITY LATERALLY RD-SG03

[BG] Пистолет за боя с горно странично казанче • [RO] Pistol ptr. vopsit • [SR] Pištolj za farbanje pneumatski • [MK] Пиштол за фарбање • [RU] Краскопулт • [SL] Brizgalna pištola • [EL] Πιστολι βαφης • [HR] Pištolj Za Boju • [FR] Pulvériser la gravité du pistolet latéralement • [IT] Pistola a spruzzo Gravità lateralmente • [ES] Spray pafilo graveco flanke • [PT] Pistola de pintura c/ copo



Art.No	gross weight	in cartoon	barcode
089910	0.490	20	3800123123184

SPRAY GUN GRAVITY LATERALLY RD-SG12

[BG] Пистолет за боя с горно странично казанче • [RO] Pistol ptr. vopsit • [SR] Pištolj za farbanje pneumatski • [MK] Пиштол за фарбање • [RU] Краскопулт • [SL] Brizgalna pištola • [EL] Πιστολι βαφης • [HR] Pištolj Za Boju • [FR] Pulvériser la gravité du pistolet latéralement • [IT] Pistola a spruzzo Gravità lateralmente • [ES] Spray pafilo graveco flanke • [PT] Pistola de pintura c/ copo



Art.No	gross weight	in cartoon	barcode
089943	0.750	10	3800972003507

SPRAY GUN SUCTION RD-SG01

[BG] Пистолет за боя с долно казанче • [RO] Pistol pentru vopsit • [SR] Pištolj za farbanje pneumatski • [MK] Пиштол за фарбање • [RU] Краскопулт • [SL] Brizgalna pištola • [EL] Πιστολι βαφης • [HR] Pištolj Za Boju • [FR] Aspiration de pistolet • [IT] Aspirazione pistola a spruzzo • [ES] Spray pingalcio • [PT] Pistola de pintura sucção



Art.No	gross weight	in cartoon	barcode
089903	0.800	10	3800123122132

SPRAY GUN WITH TANK AND HOSE RD-PT01

[BG] Пистолет за боя с казанче и маркуч • [RO] Pistol ptr. vopsit cu rezervor • [SR] Pištolj za farbanje pneumatski sa kontejnerom i crevo • [MK] Пиштол за фарбање со сад и црево • [RU] Краскопулт Красконагнетательный бак • [SL] Brizgalna pištola • [EL] Πιστολι βαφης • [HR] Pištolj Za Boju • [FR] Pistolet à peinture avec réservoir et tuyau • [IT] Pistola a spruzzo con serbatoio e tubo flessibile • [ES] Spray Pafilo kun tanko kaj maniko • [PT] Pistola de pintura sucção



Art.No	gross weight	in cartoon	barcode
089914	4.000	5	3800123122163

SPRAY GUN WITH TANK AND HOSE RD-PT02

[BG] Пистолет за боя с казанче и маркуч • [RO] Pistol ptr. vopsit cu rezervor • [SR] Pištolj za farbanje pneumatski sa kontejnerom i crevo • [MK] Пиштол за фарбање со сад и црево • [RU] Краскопулт Красконагнетательный бак • [SL] Brizgalna pištola • [EL] Πιστολι βαφης • [HR] Pištolj Za Boju • [FR] Pistolet à peinture avec réservoir et tuyau • [IT] Pistola a spruzzo con serbatoio e tubo flessibile • [ES] Spray Pafilo kun tanko kaj maniko • [PT] Pistola de pintura sucção



Art.No	gross weight	barcode
089915	7.000	3800123122156

AIR TOOLS 5 PCS KIT SPRAY GUN SUCTION RD-AT01

[BG] Пистолети за боя долно и за въздух 5 бр. к-т • [RO] Set 5 buc. accesorii compresor • [SR] Alat set 5 kom pneumatici • [MK] Комплет за фарбање 5 ком. • [RU] Набор насадок к компрессору 5 шт • [SL] Zračni set 5u jednom • [EL] Εργαλεία Αέρος 5 τεμ • [HR] Pištolj Za Boju i Za Ispuhivanje 5 komada postaviti • [FR] Air Tools 5 pièces kit d'aspiration du pistolet • [IT] Aspiratore per pistola a spruzzo per kit Air Tools 5 pezzi • [ES] 5 komputiloj kit spray gun suction • [PT] 5 pcs kit ferramentas pneumáticas

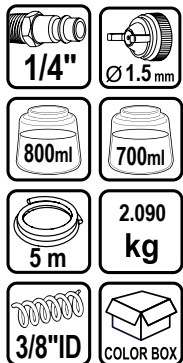

Art.No	gross weight	in carton	barcode
089902	2.100	10	3800123122149

AIR TOOLS 5 PCS KIT SPRAY GUN GRAVITY RD-AT02

[BG] Пистолети за боя горно и за въздух 5 бр. к-т • [RO] Set 5 buc. accesorii compresor • [SR] Alat set 5 kom pneumatici • [MK] Комплет за фарбање 5 ком. • [RU] Набор насадок к компрессору 5 шт • [SL] Zračni set 5u jednom • [EL] Εργαλεία Αέρος 5 τεμ • [HR] Pištolj Za Boju i Za Ispuhivanje 5 komada postaviti • [FR] Outils pneumatiques 5 pièces kit pistolet à gravité • [IT] Utensili pneumatici 5 pezzi kit pistola a spruzzo a gravità • [ES] 5 komputiloj kit spray pafilon • [PT] 5 pcs kit ferramentas pneumáticas



Art.No	gross weight	in carton	barcode
089913	0.660	10	3800123122231

COMBINED REGULATOR, AIR FILTER, WATER TRAP & LUBRICATOR RD-AF02

[BG] Пневмоподготвяща група за пневматична система • [RO] Filtru aer, regulator & lubricator • [SR] Priprema grupa • [MK] Отворање на акот за компресор • [RU] Фильтр, регулятор, смазочных материалов • [SL] Grupa pripravna za zrak • [EL] Φίλτρο αέρος, ρυθμιστής και λιπαντής • [HR] Priprema grupa • [FR] Régulateur combiné, filtre à air, piège à eau et graisseur • [IT] Regolatore combinato, filtro aria, separatore d'acqua e lubrificatore • [ES] Kombinita reguladoro • [PT] Kombinita rguladoro



Art.No	barcode
089918	3800123122170

LUBRICATOR M&F RD-A001

[BG] Омаслител за пневматична система • [RO] Mini dispozitiv de uns • [SR] Zauljivač • [MK] Мазалица за подмачкувањ • [RU] Лубрификатор • [SL] Podmazivač • [EL] Λιπαντική για пневματικό σύστημα • [HR] Mini-podmazivač • [FR] Lubrifiant pour système pneumatique • [IT] Lubrificante per sistema pneumatico • [ES] Lubrica por neumática sistema • [PT] Lubrificante para sistema pneumático



Art.No	barcode
089938	3800123153402

AIR FILTER & WATER TRAP M&F RD-AF01

• [BG] Влагоуловител за пневматична система M&F • [RO] Mini filtru • [SR] Skupljač vlage za pneumatske uređaje • [MK] Воздушен филтер и Стапица за вода • [RU] Воздушный фильтр и водоотделитель • [SL] Zračni filter • [EL] Φίλτρο αέρα και νερό παγίδα • [HR] Zračni filter za Vodu • [FR] Désaérateur pour système pneumatique • [IT] Disaeratore per sistema pneumatico • [ES] Deaerator por neumática sistema • [PT] Desaerador para sistema pneumático



Art.No	barcode
089917	3800123122002

AIR REGULATOR

• [BG] Редукцир вентил с манометър F • [RO] Regulator de aer F • [SR] Regulator pritiska • [MK] Регулятор на притисок • [RU] Воздушный регулятор • [SL] Zračni regulator • [EL] ρυθμιστής αέρα • [HR] Reducir ventil sa manometrom • [FR] Régulateur d'air • [IT] Regolatore d'aria • [ES] Aera reguligilo • [PT] Regulador de ar



Art.No	barcode
110601	3800123159299

MANOMETER

• [BG] Манометър • [RO] Manometru • [SR] Merač pritiska • [MK] Мерач на притисок • [RU] Манометр • [SL] Merilec tlaka • [EL] όργανο πίεσης • [HR] Manometar • [FR] Manomètre • [IT] Manometro • [ES] Manometer • [PT] Manómetro



Art.No	barcode
110602	3800123159305

AIR PU SPIRAL HOSE WITH QUICK COUPLINGS M&F

• [BG] Маркуч за компресор полиуретанов с бързи връзки • [RO] Furtun compresor • [SR] Crevo spiralno za vazduh • [MK] Спирално црево за воздух • [RU] Шланги спиральные пневматические • [SL] Špiralová hadica • [EL] Σωλήνα αέρος σπирάλ • [HR] Crijevo za kompresor spiralno • [FR] Tuyau en polyuréthane pour compresseur • [IT] Tubo in poliuretano per compressore • [ES] Poliuretano per komponažo • [PT] Mangueira de poliuretano para compressor



art. №	Size (Ø)	P (MPa)	P _{max} (MPa)	Lenght (m)	BARCODE
110701	6.5x9.5mm	0.83	2.4	5	3800123159312
139904	6.5x9.5mm	0.83	2.4	10	3800123123429
110702	8x12mm	0.83	2.4	15	3800123159329
110703	10x14mm	0.83	2.4	15	3800123159336

AIR PU HOSE WITH QUICK COUPLINGS M&F RD-CH02

[BG] Маркуч полиуретанов за компресор с бързи връзки • [RO] Furtun compresor • [SR] Crevo spiralno za vazduh • [MK] Спирално црево за воздух • [RU] Шланги спиральные пневматические • [SL] Špiralová hadica • [EL] Σωλήνα αέρος σπирάλ • [HR] Crijevo za kompresor • [FR] Tuyau en polyuréthane pour compresseur • [IT] Tubo in poliuretano per compressore • [ES] Poliuretano per komponažo • [PT] Mangueira de poliuretano para compressor



Art.No	barcode
089919	3800123122033

CONICAL REDUCTION

[BG] Адаптер ВРН • [RO] Niplu de reducere dublu • [SR] Nipla reducir dupla • [MK] Адаптер • [RU] Адаптер • [SL] Adapter • [EL] Προσαρμογέας • [HR] Redukcija pocinčana • [FR] Réduction conique • [IT] Riduzione conica • [ES] Konusa redukto • [PT] Redução cônica



art. №	Size (M / ")	barcode
110806	1/2" M-1/4"	3800123159350
110805	1/2" M-3/8"	3800123159343
110803	3/8" M-1/4"	3800123159367

AIR QUICK COUPLER MALE THREAD

[BG] Накрайник пневматичен бърза връзка М • [RO] Conector rapid M • [SR] Spojnica muška • [MK] Спојка, машки дел • [RU] Штуцер, с внешней резьбой • [SL] Vitič sklopke • [EL] Σύνδεσμος, αρσενικό μέρος • [HR] Spojnica muška • [FR] Raccord rapide d'air • [IT] Ugello pneumatico • [ES] Pneuimatika cigaredingo • [PT] Bico pneumático



art. №	Size (")	barcode
089937	1/2	3800123153396
089927	1/4	3800123122477
089925	1/4	3800123122453

AIR QUICK COUPLER FEMALE THREAD QC02

[BG] Накрайник пневматичен бърза връзка F • [RO] Conector rapid F • [SR] Spojnica ženska • [MK] Спојка, женски дел • [RU] Муфта соединительная, с внутренней резьбой • [SL] Spojka sklopke • [EL] Σύνδεσμος, θηλυκό μέρος • [HR] Spojnica ženska • [FR] Raccord rapide d'air • [IT] Ugello pneumatico • [ES] Pneuimatika cigaredingo • [PT] Bico pneumático



art. №	Size (")	barcode
089925	1/4	3800123122453

AIR QUICK COUPLER

[BG] Накрайник пневматичен бърза връзка маркуч • [RO] Conector • [SR] Spojnica za crevo • [MK] Спојка • [RU] Штуцер • [SL] Sklopke • [EL] Σύνδεσμος, αρσενικό μέρος • [HR] Spojnica zraka brza crijeva • [FR] Raccord rapide d'air • [IT] Ugello pneumatico • [ES] Pneuimatika cigaredingo • [PT] Bico pneumático



art. №	Size (Ø)	barcode
089930	6mm	3800123122507
110901	8mm	3800123159381
110902	10mm	3800123159398

AIR QUICK COUPLER FEMALE THREAD QC03

[BG] Накрайник пневматичен бърза връзка F • [RO] Conector rapid F • [SR] Spojnica ženska • [MK] Спојка, женски дел • [RU] Муфта соединительная, с внутренней резьбой • [SL] Spojka sklopke • [EL] Σύνδεσμος, θηλυκό μέρος • [HR] Spojnica ženska • [FR] Couplage avec filetage interne • [IT] Accoppiamento, con filettatura interna • [ES] Kunigo, kun interna fadeno • [PT] Acoplamento, com rosca interna



Art.No	barcode
089926	3800123122460

AIR QUICK COUPLER MALE THREAD QC05

[BG] Накрайник пневматичен бърза връзка М • [RO] Conector rapid M • [SR] Spojnica muška • [MK] Спојка, машки дел • [RU] Штуцер, с внешней резьбой • [SL] Vitič sklopke • [EL] Σύνδεσμος, αρσενικό μέρος • [HR] Spojnica muška • [FR] Raccords avec filetage mâle • [IT] Raccordi con filetto maschio • [ES] Agorđoj kun vira fadeno • [PT] Conexões com rosca macho



Art.No	barcode
089928	3800123122484

AIR QUICK COUPLER HOSE

[BG] Накрайник пневматичен за бърза връзка маркуч • [RO] Conector • [SR] Spojnica za crevo • [MK] Спојка • [RU] Штуцер • [SL] Sklopke • [EL] Σύνδεσμος, αρσενικό μέρος • [HR] Spojnica zraka brza crijeva • [FR] Raccords • [IT] Ugello pneumatico • [ES] Pneuimatika cigaredingo • [PT] Bico pneumático



art. №	Size (Ø)	barcode
089929	6mm	3800123122491
110903	8mm	3800123159404
110904	10mm	3800123159411

AIR QUICK COUPLINGS 5PCS KIT QCO1

[BG] Накрайници пневм. за бърза връзка 5 бр. к-т • [RO] 5Pcs/Set conectori • [SR] Spojnica za crevo • [MK] Спојка сет 5 ком • [RU] Штуцери 5бр • [SL] Sklopke 5 kos • [EL] Σύνδεσμος, αρσενικό μέρος 5 τεμάχια • [HR] Spojnica zraka brza 5 kom. postaviti • [FR] Raccords • [IT] Unione • [ES] Fitings • [PT] A articulação da fenda



1/4"



5 pcs



BLISTER

Art.No barcode
089912 3800123123123269

Y-TYPE CONNECTOR F

[BG] Тройник "Y" F • [RO] Y-Tip conector F • [SR] Račna pneumatska ženska • [MK] Спојка Y-тип женски дел • [RU] Тройник Y-образный с внутренней резьбой • [SL] Sklopke Y-type F • [EL] Σύνδεσμος, αρσενικό μέρος Y-type F • [HR] Tlačni razdjelnik spojnice • [FR] Connecteur de type Y • [IT] Connettore tipo Y • [ES] Tipo konektilo Y • [PT] Conector tipo Y



1/4"



BLISTER



Art.No barcode
110804 3800123159374

DRILL BITS 13PCS. Ø1.5-6.5MM HSS SET

[BG] Свърдело за метал HSS+R • [RO] Burghiu HSS+R • [SR] Burgija HSS+R • [MK] Бургија за метал HSS+R • [RU] Сверло по металлу HSS+R • [SL] Sveder HSS+R • [EL] Τρυπάνι για μέταλλα HSS+R • [HR] Svrdla za zidove, okrugli prihvat HSS+R • [FR] Forets à métaux HSS • [IT] Punte per metallo HSS • [ES] Metalaj taladraj bitoj HSS • [PT] Brocas de metal HSS



Art.No barcode
150681 3800972023482

DRILL BITS 19PCS. Ø1-10MM HSS SET

[BG] Свърдело за метал HSS+R • [RO] Burghiu HSS+R • [SR] Burgija HSS+R • [MK] Бургија за метал HSS+R • [RU] Сверло по металлу HSS+R • [SL] Sveder HSS+R • [EL] Τρυπάνι για μέταλλα HSS+R • [HR] Svrdla za zidove, okrugli prihvat HSS+R • [FR] Forets à métaux HSS • [IT] Punte per metallo HSS • [ES] Metalaj taladraj bitoj HSS • [PT] Brocas de metal HSS



Art.No barcode
150682 3800972023499

DRILL BITS 13PCS. Ø2-8MM HSS+TIN SET

[BG] Свърдело за метал HSS+R • [RO] Burghiu HSS+R • [SR] Burgija HSS+R • [MK] Бургија за метал HSS+R • [RU] Сверло по металлу HSS+R • [SL] Sveder HSS+R • [EL] Τρυπάνι για μέταλλα HSS+R • [HR] Svrdla za zidove, okrugli prihvat HSS+R • [FR] Forets à métaux HSS • [IT] Punte per metallo HSS • [ES] Metalaj taladraj bitoj HSS • [PT] Brocas de metal HSS



Art.No barcode
150683 3800972023505

DRILL BITS 13PCS. Ø2-8MM HSS+TIN SET

[BG] Свърдело за метал HSS+R • [RO] Burghiu HSS+R • [SR] Burgija HSS+R • [MK] Бургија за метал HSS+R • [RU] Сверло по металлу HSS+R • [SL] Sveder HSS+R • [EL] Τρυπάνι για μέταλλα HSS+R • [HR] Svrdla za zidove, okrugli prihvat HSS+R • [FR] Forets à métaux HSS • [IT] Punte per metallo HSS • [ES] Metalaj taladraj bitoj HSS • [PT] Brocas de metal HSS



Art.No barcode
150684 3800972023512

DRILL BITS SET HSS+R

[BG] Свърдела за метал к-т HSS+R • [RO] Burghiu HSS+R Pcs/Set • [SR] Burgija HSS+R kom./set • [MK] Бургија за метал HSS+R бр/сет • [RU] Набор сверла по металлу • [SL] Set svedrov • [EL] Τρυπάνια για μέταλλα • [HR] Set svrdla za metal HSS+R • [FR] Forets à métaux HSS • [IT] Punte per metallo HSS • [ES] Metalaj taladraj bitoj HSS • [PT] Brocas de metal HSS



BLISTER

art. №	Ø (mm)	drills/ pcs	BARCODE
157110	2-8	6 pcs 2, 3, 4, 5, 6, 8 mm	3800123168482
157111	1-10	10 pcs 1, 2, 3, 4, 5, 6, 7, 8, 9, 10mm	3800123168499

DRILL BIT HSS+R

[BG] Свърдело за метал HSS+R • [RO] Burghiu HSS+R • [SR] Burgija HSS+R • [MK] Бургија за метал HSS+R • [RU] Сверло по металлу HSS+R • [SL] Sveder HSS+R • [EL] Τρυπάνι για μέταλλα HSS+R • [HR] Svrdla za zidove, okrugli prihvat HSS+R • [FR] Forets à métaux HSS • [IT] Punte per metallo HSS • [ES] Metalaj taladraj bitoj HSS • [PT] Brocas de metal HSS



art. №	D1 (mm)	L1 (mm)	L2 (mm)	Qty (pcs)	barcode
157678	1.0	34	12	2	3800123168505
157679	1.5	40	18	2	3800123168512
157680	2.0	49	24	2	3800123168529
157681	2.5	57	30	2	3800123168536
157682	3.0	61	33	2	3800123168543
157683	3.2	65	36	2	3800123168550
157684	3.5	70	39	2	3800123168567
157685	4.0	75	43	2	3800123168574
157686	4.2	75	43	1	3800123168581
157687	4.5	80	47	1	3800123168598
157688	5.0	86	52	1	3800123168604
157689	6.0	93	57	1	3800123168611
157690	6.5	101	63	1	3800123168628
157691	7.0	109	69	1	3800123168635
157692	8.0	117	75	1	3800123168642
157693	10.0	133	87	1	3800123168659
157694	12.0	151	101	1	3800123168666

DRILL BITS FOR METAL 15 PCS SET HSS+TIN

[BG] Свърдело за метал 15 бр. к-т • [RO] Burghiu 15 Pcs/Set • [SR] Burgija HSS+TIN 15 kom./set • [MK] Бургија за метал 15 бр/сет • [RU] Набор сверла по металлу • [SL] Set svedrov 15 del • [EL] Τρυπάνια για μέταλλα 15 τεμ • [HR] Set svrdla za metal 15 kom • [FR] Forets à métaux • [IT] Punte per metallo • [ES] Metalaj taladraj bitoj • [PT] Brocas de metal

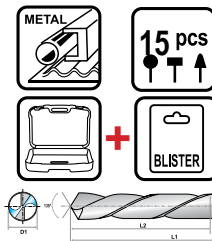

Ш 1.5-10mm

DRILLS 10 pcs:
Ø1.5x2, 2.0x2, 2.5x2, 3.0, 3.2, 3.5, 4.0, 4.5, 5.0, 6.0, 8.0, 10.0mm



Art.No	barcode
157789	3800123169540

DRILL BITS FOR METAL & CONCRETE 17 PCS SET

[BG] Свърдело за метал и бетон 17 бр. к-т • [RO] Burghiu pentru metal și beton • [SR] Burgija za metal i beton 17 kom./set • [MK] Бургија за метал и бетон 17 бр/сет • [RU] Набор сверла по металлу и бетона 17шт • [SL] Set svedrov kovine in beton 17 del • [EL] Τρυπάνια για μέταλλο και σκυρόδεμα 17 τεμ • [HR] Set svrdla za metal i beton 17 kom • [FR] Forets pour le métal et le béton • [IT] Trapani per metallo e calcestruzzo • [ES] Driljo por metallo kaj betono • [PT] Brocas para metal e betão



Ш 1.5-10mm

Metal 12 pcs: Ø1.5, 2.0, 2.5, 3.0, 3.2, 3.5, 4.0, 4.5, 4.8, 5.0, 5.5, 6.0mm
Concrete 5 pcs: Ø3.0, 5.0, 6.0, 8.0, 10.0mm



Art.No	barcode
157796	3800123169618

STEP DRILL BIT SPIRAL FLUTE HSS+TIN

[BG] Свърдело за ламарина с титановидно HSS+TIN • [RO] Burghiu HSS+TIN • [SR] Burgija HSS+TIN • [MK] Бургија за метал HSS+TIN • [RU] Набор сверла по металлу HSS+TIN • [SL] Sveder HSS+TIN • [EL] Τρυπάνια για μέταλλα HSS+TIN • [HR] Set svrdla za metal HSS+TIN • [FR] Perceuse pour tôle HSS+TIN • [IT] Trapano per lamiera HSS+TIN • [ES] Taladros HSS+TIN • [PT] Broca para metal de folha HSS+TIN



art. №	Ø(mm)	HEX	barcode
150678	4-12	1/4"	3800972004986
150679	4-20	1/4"	3800972004993
150680	6-30	1/4"	3800972005006

DRILL BIT HSS TIN

[BG] Свърдело за метал HSS • [RO] Burghiu HSS • [SR] Burgija HSS • [MK] Бургија за метал HSS • [RU] Сверло по металлу • [SL] Sveder HSS • [EL] Τρυπάνι για μέταλλα HSS • [HR] Svrdla za metal HSS • [FR] Forets à métaux HSS • [IT] Punte per metallo HSS • [ES] Metalaj taladraj bitoj HSS • [PT] Brocas de metal HSS



DIN 338
HSS+TIN SPLIT
POINT TYPE C

art. №	D1 (mm)	L1 (mm)	L2 (mm)	Qty (pcs)	barcode
150655	1.0	34	12	2	3800123164262
150656	1.5	40	18	2	3800123164279
150657	2.0	49	24	2	3800123164286
150658	2.5	57	30	2	3800123164293
150659	3.0	61	33	2	3800123164309
150660	3.2	65	36	2	3800123164316
150661	3.5	70	39	2	3800123164323
150662	4.0	75	43	2	3800123164330
150663	4.2	75	43	1	3800123164347
150664	4.5	80	47	1	3800123164354
150665	4.8	86	52	1	3800123164361
150666	5.0	86	52	1	3800123164378
150667	5.5	93	57	1	3800123164385
150668	6.0	93	57	1	3800123164392
150669	6.5	101	63	1	3800123164408
150670	7.0	109	69	1	3800123164415
150671	8.0	117	75	1	3800123164422
150672	8.5	117	75	1	3800123164439
150673	9.0	125	81	1	3800123164446
150674	10.0	133	87	1	3800123164453
150675	11.0	142	94	1	3800123164460
150676	12.0	151	101	1	3800123164477
150677	13.0	151	101	1	3800123164484

DRILL BITS 6 PCS SET HSS-CO

[BG] Свърдело за метал 6 бр. к-т HSS-Co • [RO] Burghiu HSS-Co 6 Pcs/Set • [SR] Burgija HSS-Co 6 kom./set • [MK] Бургија за метал HSS-Co 6 бр/сет • [RU] Набор сверла по металлу 6 шт HSS-Co • [SL] Set svedrov HSS-Co 6 del • [EL] Τρυπάνια για μέταλλα HSS-Co 6 τεμ • [HR] Set svrdla za metal HSS-Co 6 kom • [FR] Forets à métaux HSS-Co • [IT] Punte per metallo HSS-Co • [ES] Metalaj taladraj bitoj HSS-Co • [PT] Brocas de metal HSS-Co



DRILLS
6 pcs: 2, 3, 4, 5, 6, 8 mm

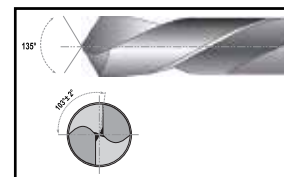

Art.No	barcode
157112	3800123168673

DRILL BIT HSS-CO

[BG] Свърделно за метал HSS-Co • [RO] Burghiu HSS-Co • [SR] Burgija HSS-Co • [MK] Бургџија за метал HSS-Co • [RU] Сверло по металлу HSS-Co • [SL] Sveder HSS-Co • [EL] Τρυπάνι για μέταλλα HSS-Co • [HR] Svrdal za metal HSS-Co • [FR] Forets à métaux HSS-Co • [IT] Punte per metallo HSS-Co • [ES] Metalaj taladraj bitoj HSS-Co • [PT] Brocas de metal HSS-Co



COBALT



art. №	D1 (mm)	L1 (mm)	L2 (mm)	Qty (pcs)	BARCODE
157695	2.0	49	24	2	3800123168680
157696	2.5	57	30	2	3800123168697
157697	3.0	61	33	2	3800123168703
157698	3.2	65	36	2	3800123168710
157699	3.5	70	39	2	3800123168727
157700	4.0	75	43	2	3800123168734
157715	4.2	75	43	1	3800123168741
157716	4.5	80	47	1	3800123168758
157717	5.0	86	52	1	3800123168765
157718	6.0	93	57	1	3800123168772
157719	6.5	101	63	1	3800123168789
157720	7.0	109	69	1	3800123168796
157721	8.0	117	75	1	3800123168802
157722	10.0	133	87	1	3800123168819
157723	12.0	151	101	1	3800123168826

MASONRY DRILL BITS 5 PCS SET

[BG] Свърделна за бетон 5 бр. комплект • [RO] 5Pcs/Set burghie • [SR] Burgija za zid Set 5 kom • [MK] Бургџија сет 5 ком • [RU] Сверло по бетону набор 5 шт • [SL] Sveder za beton nabor 5 kos • [EL] Τρυπάνι για το σκυρόδεμα сет 5 τεμαχίων • [HR] Svrdla za zidove 5kom • [FR] Forets de maçonnerie • [IT] Bit di perforazione in muratura • [ES] Konkretaj triloj • [PT] Brocas de concreto

Ш 4, 5, 6, 8, 10mm

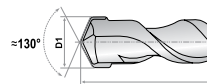

Art.No	barcode
157113	3800123168833

MASONRY DRILL BITS 15 PCS SET

[BG] Свърделна за бетон 15 бр. комплект • [RO] 15 Pcs/Set burghie • [SR] Burgija za zid Set 15 kom • [MK] Бургџија сет 15 ком • [RU] Сверло по бетону набор 15 шт • [SL] Sveder za beton nabor 15 kos • [EL] τρυπάνι για το σκυρόδεμα сет 15 τεμαχίων • [HR] Svrdla za zidove 15kom • [FR] Forets de maçonnerie • [IT] Bit di perforazione in muratura • [ES] Konkretaj triloj • [PT] Brocas de concreto



Masonry Drills 15 pcs:
3.0x3, 4.0x3, 5.0x3,
6.0x2, 8.0x2, 10.0x2

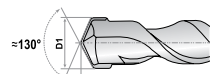

Art.No	barcode
157790	3800123169557

MASONRY DRILL BIT

[BG] Свърделно за бетон • [RO] Carote diamantate • [SR] Burgija za zid • [MK] Бургџија • [RU] Сверло по бетону • [SL] Sveder za beton • [EL] τρυπάνι για το σκυρόδεμα • [HR] Svrdlo za zidove, okrugli prihvat • [FR] Forets de maçonnerie • [IT] Bit di perforazione in muratura • [ES] Konkretaj triloj • [PT] Brocas de concreto

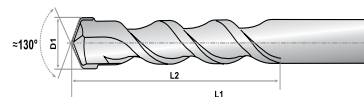

art. №	D1 (mm)	L1 (mm)	L2 (mm)	barcode
157724	Ø3	70	30	3800123168840
157725	Ø4	75	40	3800123168857
157726	Ø5	85	50	3800123168864
157727	Ø6	100	60	3800123168871
157729	Ø8	120	80	3800123168895
157730	Ø10	150	90	3800123168901

BRAD POINT DRILL BITS FOR WOOD 5 PCS SET

[BG] Свърделна за дърво 5 бр. к-т • [RO] Burghiu ptr lemn 5 buc/Set • [SR] Burgija za drvo 5 kom./set • [MK] Бургџија за дрво 5 бр/сет • [RU] Набор сверла по дереву 5 шт. • [SL] Set svedrov lesa 5 del • [EL] Τρυπάνια για ξύλο 5 τεμ • [HR] Set svrdla za drvo 5kom • [FR] Jeu de forets pour bois • [IT] Set di punte per legno • [ES] Aro da taladroj por ligno • [PT] Conjunto de brocas para madeira

Ш 4, 5, 6, 8, 10mm



Art.No	barcode
157114	3800123168918

BRAD POINT DRILL BITS FOR WOOD 15 PCS SET

[BG] Свърделна за дърво 15 бр. к-т • [RO] Burghiu ptr lemn 15 buc/Set • [SR] Burgija za drvo 15 kom./set • [MK] Бургџија за дрво 15 бр/сет • [RU] Набор сверла по дереву 15 шт. • [SL] Set svedrov lesa 15 del • [EL] Τρυπάνια για ξύλο 15 τεμ • [HR] Set svrdla za drvo 15kom • [FR] Jeu de forets pour bois • [IT] Set di punte per legno • [ES] Aro da taladroj por ligno • [PT] Conjunto de brocas para madeira

Ш 3, 3.5, 4, 4.5, 5, 5.5, 6, 6.5, 7, 8, 10mm

DRILLS 15 pcs:
Ø3.0x3, 3.5x2, 4.0x2,
4.5, 5.0, 5.5, 6.0, 6.5,
7.0, 8.0, 10.0mm



Art.No	barcode
157791	3800123169564

BRAD POINT DRILL BITS FOR WOOD

[BG] Свредло за дърво • [RO] Burghiu pentru lemn • [SR] Burgija za drvo • [MK] Бургџија за дрво
 • [RU] Сверла по древо • [SL] Svedro lesa • [EL] Τρυπάνια για ξύλο • [HR] Svrđalo za drvo
 • [FR] Jeu de forets pour bois • [IT] Set di punte per legno • [ES] Aro da taladroj por ligno
 • [PT] Conjunto de brocas para madeira



art. №	Ø (mm)	barcode
157731	Ø3	3800123168925
157732	Ø4	3800123168932
157733	Ø5	3800123168949
157734	Ø6	3800123168956
157736	Ø8	3800123168970
157737	Ø10	3800123168987
157738	Ø12	3800123168994

FLAT SPEED SPADE BITS FOR WOOD 1/4" HEX SHANK

[BG] Свредла за дърво плоски 1/4" hex 7 бр. к-т • [RO] Burghiu ptr lemn 1/4" hex 7 buc/Set
 • [SR] Burgija za drvo 1/4" hex 7 kom./set • [MK] Бургџија за дрво 1/4" hex 7 бр/сет • [RU] Набор сверла по древо 1/4" hex 7 шт. • [SL] Set svedrov lesa 1/4" hex 7 del • [EL] Τρυπάνια για ξύλο 1/4" hex 7 τεμ • [HR] Set svrdla za drvo 1/4" hex 7kom • [FR] Jeu de forets pour bois • [IT] Set di punte per legno • [ES] Aro da taladroj por ligno • [PT] Conjunto de brocas para madeira



DRILLS 7 pcs: Ø10, 12, 16, 19, 22, 25, 32mm



Art.No	barcode
157794	3800123169595

FLAT SPEED SPADE BITS FOR WOOD 1/4" HEX SHANK

[BG] Свредла за дърво плоски 1/4" hex • [RO] Burghiu ptr sticlă 1/4" hex • [SR] Burgija za drvo 1/4" hex • [MK] Бургџија за дрво 1/4" hex • [RU] Набор сверла по древо 1/4" hex • [SL] Set svedrov lesa 1/4" hex • [EL] Τρυπάνια για ξύλο 1/4" hex • [HR] Set svrdla za drvo 1/4" hex • [FR] Jeu de forets pour bois • [IT] Set di punte per legno • [ES] Aro da taladroj por ligno • [PT] Conjunto de brocas para madeira



art. №	Ø (mm)	barcode
157739	Ø14	3800123169014
157740	Ø16	3800123169021
157741	Ø20	3800123169038
157742	Ø22	3800123169045
157743	Ø25	3800123169052
157744	Ø28	3800123169069
157745	Ø30	3800123169076

GLASS AND TILE DRILL BITS 3 PCS SET

[BG] Свредла за стъкло 3 броя к-т • [RO] Burghiu ptr sticlă 3 buc/Set • [SR] Burgija za staklo 3 kom./set [MK] Бургџија за стакло 3 бр/сет • [RU] Набор сверла по стакло 3 шт. • [SL] Set svedrov steklo 3 del • [EL] Τρυπάνια για ποτήρι 3 τεμ • [HR] Set svrdla za staklo 3 kom • [FR] Set de perceuse à verre • [IT] Trapano fissato su vetro • [ES] Fiksita pilko • [PT] Conjunto de broca de vidro



**DRILLS 3 pcs:
Ø5.0, 6.0, 8.0mm**



Art.No	barcode
157115	3800123169250

GLASS AND TILE DRILL BITS 5 PCS SET

[BG] Свредла за стъкло 5 броя к-т • [RO] Burghiu ptr sticlă 5 buc/Set • [SR] Burgija za staklo 5 kom./set • [MK] Бургџија за стакло 5 бр/сет • [RU] Набор сверла по стакло 5 шт. • [SL] Set svedrov steklo 5 del • [EL] Τρυπάνια για ποτήρι 5 τεμ • [HR] Set svrdla za staklo 5 kom • [FR] Set de perceuse à verre • [IT] Trapano fissato su vetro • [ES] Fiksita pilko • [PT] Conjunto de broca de vidro

**DRILLS 5 pcs:
Ø3.0, 4.0, 6.0, 8.0, 10.0mm**



Art.No	barcode
157798	3800123169632

GLASS AND TILE DRILL BIT

[BG] Свредло за стъкло • [RO] Burghiu ptr sticlă • [SR] Burgija za staklo • [MK] Бургџија за стакло • [RU] Сверло для стекла • [SL] Svedro za steklo • [EL] Τρυπάνι για ποτήρι • [HR] Svrđalo za staklo i keramike • [FR] Set de perceuse à verre • [IT] Trapano fissato su vetro • [ES] Fiksita pilko • [PT] Conjunto de broca de vidro



art. №	Ø (mm)	barcode
157763	Ø3	3800123169267
157764	Ø4	3800123169274
157765	Ø5	3800123169281
157766	Ø6	3800123169298
157767	Ø8	3800123169304
157768	Ø10	3800123169311
157769	Ø12	3800123169328

ADAPTOR FROM SDS-MAX TO SDS-PLUS

[BG] Адаптер от SDS-max към SDS-plus • [RO] Adaptor de la SDS MAX-SDS PLUS • [SR] Adapter sa SDS-max da SDS-plus • [MK] Адаптер • [RU] Адаптер с SDS-Max на SDS-Plus • [SL] Adapter iz SDS-max, da SDS-plus • [EL] Μετατροπέας SDS-max σε SDS-plus • [HR] SDS-MAX Adapter • [FR] Adaptateur avec SDS-Max à SDS-Plus • [IT] Adattatore con SDS-Max a SDS-Plus • [ES] Adaptilo kun SDS-Max al SDS-Plus • [PT] Adaptador com SDS-Max para SDS-Plus



Art.No	barcode
159916	3800123141805



HOLESAW ARBOR SDS-PLUS WITH PILOT MASONRY DRILL BIT

[BG] Водач SDS-plus за боркорона • [RO] Tijă conectoare SDS-PLUS • [SR] Vodilica za kruna • [MK] Водач за круна за бетон за торна SDS+ • [RU] Бур за Колонковая бур фреза • [SL] Vodič za krona za vrtnanje betona • [EL] Οδηγός τρυπάνι SDS-plus • [HR] Nosač s svrdlom za centriranje • [FR] Couronne carbure pour béton SDS-plus • [IT] Corona per metallo duro per calcestruzzo SDS-plus • [ES] Krono por karburo por betono SDS-plus • [PT] Coroa de carboneto para betão SDS-plus



art. №	SDS	length	barcode
154811	plus	200	3800123102516
154805	plus	300	3800123122705
157801	plus	500	3800123162725
157802	max	500	3800123163777

CARBIDE CORE CUTTER WITH HOLESAW ARBOR&PILOT MASONRY DRILL BIT

[BG] Боркорона за бетон с водач и свредло • [RO] Adaptor pentru freza cu miez din carbura [SR] Adapter rezač jezgre od karbida • [MK] Адаптер за сечење карбид • [RU] Адаптер твердосплавный резак • [SL] Adapter rezkar za jedro iz karbida • [EL] Μετατροπέας καρβιδίου [HR] Rezač jezgre od karbidne jezgre • [FR] Fraise à noyau en carbure • [IT] AFresa in metallo duros • [ES] Karburilo kerna trançilo • [PT] Cortador de núcleo de metal duro

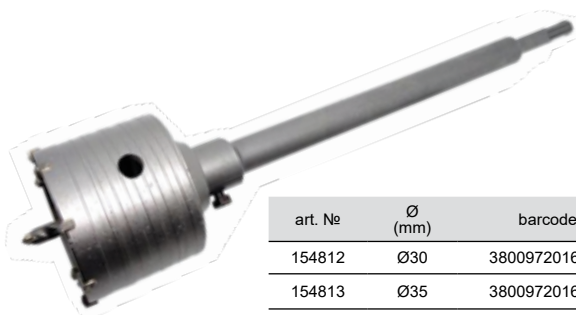

art. №	Ø (mm)	barcode
154812	Ø30	3800972016729
154813	Ø35	3800972016736
154814	Ø45	3800972016743
154815	Ø65	3800972016750
154816	Ø85	3800972016767
154817	Ø130	3800972016774



CHISELS SDS-PLUS 3 PCS. SET

[BG] Длета SDS-plus 3 броя к-т • [RO] 3Pcs/Set dalti SDS • [SR] Sekači 3 kom Set SDS-plus • [MK] Длета SDSplus 3 ком сет • [RU] Набор долота SDS плюс 3 шт. • [SL] Sekači 3 kos Set • [EL] Σετ SDS PLUS 3 τεμαχίων • [HR] SDS-Plus Dlijeto 3kom • [FR] SDS jeu de ciseaux SDS plus • [IT] Set di scalpelli SDS plus • [ES] SDS çizilo aro plus • [PT] Conjunto de cinzel SDS mais

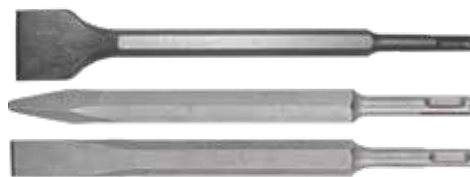

Art.No	barcode
159904	3800123125263

HOLLOW GOUGING CHISEL SDS-PLUS

[BG] Длето-каналопател SDS-plus • [RO] Dalta scobit SDS-PLUS • [SR] Sekač kanalni SDS-plus • [MK] Длето за канал • [RU] Долото SDS-PLUS • [SL] Dleto za kanal • [EL] Καλέμι αυλακώσεων SDS-Plus • [HR] Dlijeto za utore • [FR] Achat de SDS-PLUS • [IT] Scalpello scavato per scalpello SDS-plus • [ES] Hollow Gouging Chisel SDS-plus • [PT] Cinzel de cinzelamento oco SDS-plus

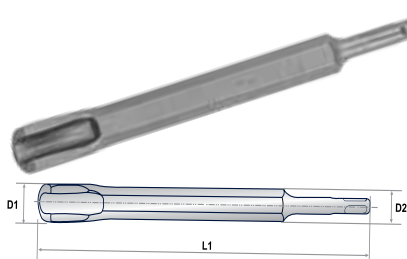

art. №	L1/mm	D1/mm	D2/mm	barcode
154001	250	23	14	3800123125645
154002	250	23	17	3800123125645

TILE CHISEL SDS-PLUS

[BG] Длето-лопатка SDS-plus • [RO] Dalta lata SDS-plus • [SR] Sekač SDS-plus • [MK] Длето SDS-plus • [RU] Долото широкое SDS-PLUS • [SL] Dleto SDS-plus • [EL] Καλέμι διαβάθμισης • [HR] Široko dlijeto hex • [FR] SDS-PLUS burin large • [IT] Praticare un po' di bit SDS-PLUS • [ES] SDS-PLUS larğa çizilo • [PT] Formão largo SDS-PLUS

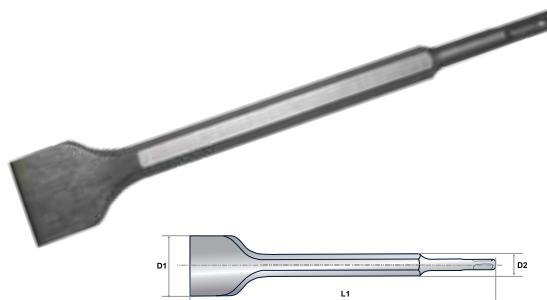

art. №	L1/mm	D1/mm	D2/mm	barcode
154007	250	40	14	3800123159985
154008	250	40	14	3800972002524

FLAT CHISEL SDS-PLUS

[BG] Длето-секач SDS-plus • [RO] Dalta SDS-PLUS • [SR] Sekač SDS-plus • [MK] Длето SDS-plus • [RU] Долото SDS-PLUS • [SL] Dleto SDS-plus • [EL] Καλέμι διαβάθμισης • [HR] Plosnato dljeto • [FR] SDS-PLUS burin • [IT] Scalpello SDS-PLUS • [ES] SDS-PLUS çizilo • [PT] Formão SDS-PLUS

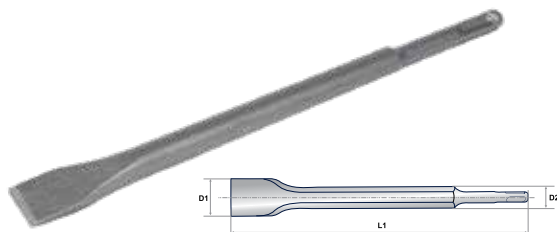

art. №	L1/mm	D1/mm	D2/mm	barcode
154003	250	20	14	3800123125638
154010	250	20	14	3800972005020
154004	250	23	17	3800123125669

POINT CHISEL SDS-PLUS

[BG] Длето-шило SDS-plus • [RO] Spit SDS-PLUS • [SR] Špic SDS-plus • [MK] Длето остро SDS-plus • [RU] Долото пика SDS-PLUS • [SL] Dleto konica SDS-plus • [EL] Βελόνη SDS-plus • [HR] Šiljato dljeto hex • [FR] Burin de pointe SDS-PLUS • [IT] Scalpello di punta SDS-PLUS • [ES] SDS-PLUS pinta çizilo • [PT] Bit de pico SDS-PLUS

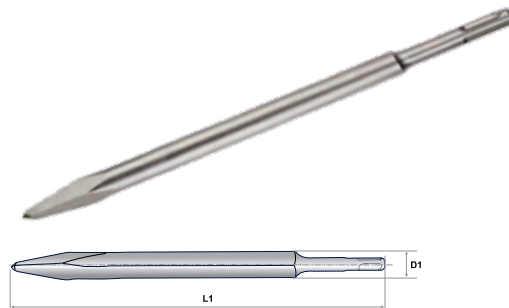

art. №	L1/mm	D1/mm	barcode
154005	250	14	3800123125621
154009	250	14	3800972005013
154006	250	17	3800123125652

TILE CHISEL SDS-MAX

[BG] Длето-лопатка SDS-max • [RO] Dalta lata SDS-max • [SR] Sekač SDS-max • [MK] Длето SDS-max • [RU] Долото широкое SDS-max • [SL] Dleto SDS-max • [EL] Καλέμι διαβάθμισης SDS-max • [HR] Široko dljeto • [FR] SDS-PLUS burin large • [IT] Praticare un po 'di bit SDS-PLUS • [ES] SDS-PLUS larğa çizilo • [PT] Formão largo SDS-PLUS



L1: 300mm
D1: 50mm
D2: 18mm



Art.No barcode
154201 3800123145049

FLAT CHISEL SDS-MAX

[BG] Длето-секач SDS-max • [RO] Dalta SDS-max • [SR] Sekač SDS-max • [MK] Длето SDS-max • [RU] Долото SDS-max • [SL] Dleto SDS-max • [EL] Καλέμι διαβάθμισης • [HR] Plosnato dljeto • [FR] SDS-max burin • [IT] Scalpello SDS-max • [ES] SDS-max çizilo • [PT] Formão SDS-max



L1: 400mm
D1: 25mm
D2: 18mm

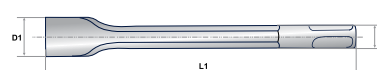

Art.No barcode
154202 3800123145032

POINT CHISEL SDS-MAX

[BG] Длето-шило SDS-max • [RO] Spit SDS-max • [SR] Špic SDS-max • [MK] Длето остро SDS-max • [RU] Долото пика SDS-max • [SL] Dleto konica SDS-max • [EL] Βελόνη SDS-max • [HR] Šiljato dljeto • [FR] Le bit de pointe SDS-max • [IT] Scalpello di punta SDS-max • [ES] La pinto SDS-max • [PT] Pico SDS-max

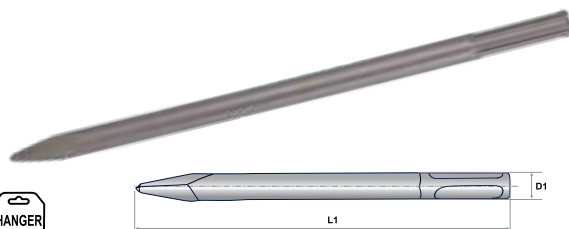

L1: 400mm
D1: 18mm



Art.No barcode
154203 3800123145025

FLAT CHISEL SDS-MAX

[BG] Длето-секач SDS-max • [RO] Dalta SDS-max • [SR] Sekač SDS-max • [MK] Длето SDS-max • [RU] Долото SDS-max • [SL] Dleto SDS-max • [EL] Καλέμι διαβάθμισης • [HR] Plosnato dljeto • [FR] SDS-max burin • [IT] Scalpello SDS-max • [ES] SDS-max çizilo • [PT] Formão SDS-max



L1: 600mm
D1: 25mm
D2: 18mm



Art.No barcode
154204 3800972009011

POINT CHISEL SDS-MAX

[BG] Длето-шило SDS-max • [RO] Spitz SDS-max • [SR] Špic SDS-max • [MK] Длето остро SDS-max [RU] Долото пика SDS-max • [SL] Dleto konica SDS-max • [EL] βελόνι SDS-max • [HR] Šiljato dljeto • [FR] Le bit de pointe SDS-max • [IT] Scalpello di punta SDS-max • [ES] La pinto SDS-max • [PT] Pico SDS-max

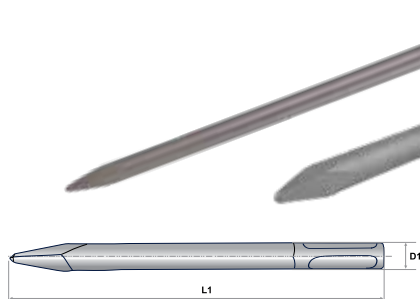

SDS max

**L1: 600mm
D1: 18mm**

Art.No barcode
154205 3800972009028

HOLLOW GOUGING CHISEL

[BG] Длето-каналокончател SDS-max • [RO] Dalta pentru canale SDS-max • [SR] Šuplje dleto SDS-max • [MK] Длето остро SDS-max • [RU] Долото SDS-max • [SL] Dleto konica SDS-max • [EL] SDS-max σμίλη • [HR] Šiljato dljeto • [FR] Burin SDS-max • [IT] Scalpello SDS-max • [ES] SDS-max cizilo • [PT] Cinzel SDS-max



SDS max

**L1: 250mm
D1: 25mm
D2: 18mm**

Art.No barcode
154206 3800972016064

HAMMER DRILL BIT SDS-MAX

[BG] Свърдело SDS-max • [RO] Burghie beton SDS-max • [SR] Burgija za zid SDS-max • [MK] Бургија SDS-max • [RU] Сверло по бетону SDS-max • [SL] Sveder za beton SDS-max • [EL] τρυπάνι για το σκυρόδεμα SDS-max • [HR] Svrdlo za zidove SDS-max • [FR] Foret à béton SDS-max • [IT] Trapano per calcestruzzo SDS-max • [ES] SDS-max Konkreta Borilo • [PT] Broca de concreto SDS-max



art. №	D1 (mm)	L1 (mm)	L2 (mm)	barcode
153802	Ø10	260	130	3800123125942
153803	Ø12	260	130	3800123125959
153804	Ø16	400	270	3800123125966
153805	Ø20	400	270	3800123125973
153806	Ø22	505	370	3800123125980
153807	Ø25	600	470	3800123125997
153801	Ø32	600	470	3800123145018
153808	Ø12	400	290	3800972010468
153809	Ø14	400	290	3800972010475
153810	Ø16	600	490	3800972010482
153811	Ø16	1000	890	3800972010499
153812	Ø18	600	490	3800972010505
153813	Ø18	1000	890	3800972010512
153814	Ø20	600	490	3800972010529
153815	Ø20	1000	890	3800972010536
153816	Ø22	1000	890	3800972010543
153817	Ø25	1000	890	3800972010550
153818	Ø25	1000	490	3800972010567
153819	Ø30	600	890	3800972010574
153820	Ø35	1000	890	3800972010581



HAMMER DRILL BITS SDS-PLUS 5 PCS SET

[BG] Свърделна SDS-plus 5 бр. комплект • [RO] 5Pcs/Set burghie SDS-PLUS • [SR] Burgija za zid SDS-plus Set 5 kom • [MK] Бургија SDS-plus сет 5 ком • [RU] Сверло по бетону SDS-plus набор 5 шт • [SL] Sveder za beton SDS-plus nabor 5 kos • [EL] τρυπάνι για το σκυρόδεμα SDS-plus сет 5 τεμαχίων • [HR] Svrdla za zidove SDS-plus 5kom • [FR] Foret à béton SDS-plus • [IT] Punta per calcestruzzo SDS-plus • [ES] Drilo por betono SDS-plus • [PT] Broca para betão SDS-plus



**DRILLS 5 pcs:
Ø10, 12, 16, 19, 22, 25, 32mm**

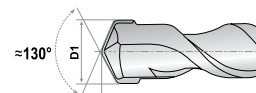

5 pcs

SDS+

Art.No barcode
158101 3800123125591

ADJUSTABLE HOLE CUTER UP TO Ø120MM FOR WOOD

[BG] Боркорона за дърво до Ø120mm • [RO] Freza lemn reglabila-pna la 120mm • [SR] Krunska glava za bušenje • [MK] Круна за дрво • [RU] Набор коронка для дерева • [SL] Kronska žaga za les • [EL] Κορώνα για την κοπή ξύλο • [HR] Krana za drvo • [FR] Couronne sertie de bois • [IT] Corona per legno • [ES] Krono starigita por ligno • [PT] Coroa para madeira



**Ø mm
0-120**

WOOD



Art.No barcode
157703 3800123121579

HOLESAW Ø54MM AND DRILL BIT Ø22MM KIT

[BG] Боркорона Ø54mm и свърдело Ø22mm за дърво к-т • [RO] Set carota 54mm si burghiu pentru lemn 22mm • [SR] Krunska glava za bušenje i burgija za drvo set • [MK] Круна и Бургија за дрво сет • [RU] Биметаллическая коронка и Сверло для дерева набор • [SL] Kronska žaga za les in sveder nastav • [EL] Κορώνα για την κοπή ξύλο & Τρυπάνι Σετ • [HR] Krana i Svrdlo za drvo • [FR] Couronne bimétallique et foret pour jeu de bois • [IT] Corona bimetallica e punta per legno • [ES] Bimetala krono kaj taladro bito por ligno aro • [PT] Coroa bimetalica e broca para madeira

**Ø54mm
Ø22mm**

WOOD

BLISTER



Art.No barcode
157701 3800123121180

HAMMER DRILL BIT SDS-PLUS

[BG] Свърдело SDS-plus • [RO] Burghie beton SDS-plus • [SR] Burghija za zid SDS-plus
 • [MK] Бургија SDS-plus • [RU] Сверло по бетону SDS-plus • [SL] Sveder za beton SDS-plus •
 [EL] Τρυπάνι για το σκυρόδεμα SDS-plus • [HR] Svrdlo za zidove SDS-plus • [FR] Foret à béton
 SDS-max • [IT] Trapano per calcestruzzo SDS-max • [ES] SDS-max Konkreta Borilo • [PT] Broca
 de concreto SDS-max



art. №	D1 (mm)	L1 (mm)	L2 (mm)	barcode
159910	4	110	50	3800123150159
153630	5	110	50	3800123160165
153629	5	160	100	3800123160158
153634	5	210	150	3800123160219
153631	6	110	50	3800123160172
153601	6	160	100	3800123125447
153602	6	210	150	3800123125454
153632	8	110	50	3800123160189
153616	8	160	100	3800123160028
153603	8	210	150	3800123125478
153604	8	260	200	3800123125461
153617	8	350	300	3800123160035
153652	8	450	400	3800123160615
153633	10	110	50	3800123160196
153605	10	160	100	3800123125485
153606	10	210	150	3800123125492
153618	10	260	200	3800123160042
153607	10	310	250	3800123125508
153619	10	350	300	3800123160059
153620	10	460	400	3800123160066
153621	12	160	100	3800123160073
153608	12	210	150	3800123125515
153609	12	310	250	3800123125522
153622	12	350	300	3800123160080
153623	12	450	400	3800123160097
153624	14	160	100	3800123160103
153635	14	210	150	3800123160226
153636	14	260	200	3800123160233
153653	14	310	250	3800123160622
153625	14	350	300	3800123160110
153610	14	450	400	3800123125539
153638	16	160	100	3800123160257
153639	16	210	150	3800123160264
153651	16	300	250	3800123160608
153626	16	350	300	3800123160127
153611	16	450	400	3800123125546
153640	18	210	150	3800123160271
153627	18	350	300	3800123160134
153612	18	450	400	3800123125553
153628	20	350	300	3800123160141
153613	20	450	400	3800123125560
153614	22	450	400	3800123125577
153646	24	450	400	3800123160332
153615	26	450	400	3800123125584
153647	28	450	400	3800123160349
153648	30	450	400	3800123160356
153649	32	450	400	3800123160363
153682	14	1000	950	3800972010598
153683	18	1000	950	3800972010604
153684	22	1000	950	3800972010611
153685	30	1000	950	3800972010628
153686	32	1000	950	3800972010635

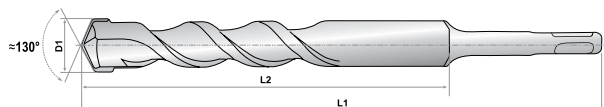

HAMMER DRILL BIT CROSS HEAD SDS-PLUS

[BG] Свърдело Cross Head SDS-plus • [RO] Burghie beton Cross Head SDS-plus • [SR] Burghija
 za zid Cross Head SDS-plus • [MK] Бургија Cross Head SDS-plus • [RU] Сверло по бетону
 Cross Head SDS-plus • [SL] Sveder za beton SDS-plus • [EL] τρυπάνι για το σκυρόδεμα SDS-
 plus • [HR] Svrdlo za zidove SDS-plus 4-Plus • [FR] Foret à béton Cross Head SDS-plus • [IT]
 Trapano per calcestruzzo Cross Head SDS-plus • [ES] Cross Head SDS-plus Konkreta Borilo •
 [PT] Broca de concreto Cross Head SDS-plus



art. №	D1 (mm)	L1 (mm)	L2 (mm)	BARCODE
153656	6	110	50	3800123151255
153657	6	160	100	3800123151262
153658	6	210	150	3800123151279
153659	6.5	260	200	3800123151286
153660	8	110	50	3800123151293
153661	8	160	100	3800123151309
153662	8	210	150	3800123151316
153663	8	260	200	3800123151323
153664	8	350	300	3800123151330
153665	10	160	100	3800123151347
153666	10	210	150	3800123151354
153667	10	260	200	3800123151361
153668	10	350	300	3800123151378
153669	10	450	400	3800123151385
153670	12	210	150	3800123151392
153671	12	350	300	3800123151408
153672	12	450	400	3800123151415
153673	14	160	100	3800123151422
153674	14	210	150	3800123151439
153675	14	260	200	3800123151446
153676	14	350	300	3800123151453
153677	14	450	400	3800123151460
153678	16	260	210	3800972003156
153679	18	260	210	3800972003163
153680	20	260	210	3800972003170
153681	24	260	210	3800972003187

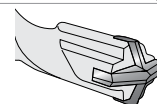
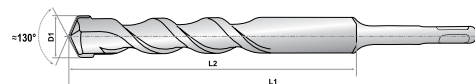

Cross Head

SHEET METAL HOLESAW WITH PILOT HSS DRILL BIT

[BG] Боркорона за ламарина с водач HSS • [RO] Freza gaurire HSS • [SR] Krunska glava za
 bušenje HSS • [MK] Круна за лим са бургија HSS • [RU] Биметаллическая корона резки
 листового металла HSS • [SL] Kronska žaga za pločevina HSS • [EL] Κορώνα για την κοπή
 λαμαρίνας • [HR] Kruna za lim s vodič HSS • [FR] Tôle de coupe de couronne bimétallique HSS •
 [IT] Lamiera di metallo a corona bimetallica HSS • [ES] Bimetala krono tranča metalo HSS • [PT]
 Chapa de corte bimetalica HSS



art. №	Ø / mm	barcode
154801	25	3800123160424
154802	35	3800123160431

HOLE CUTTERS Ø19-127MM 16 PCS KIT FOR WOOD

[BG] Боркорони 16 части комплект • [RO] 16Pcs/Set Freza gaurire • [SR] Krunska glava za bušenje na drvo 16kom • [MK] Круна за дрво 16ком • [RU] Набор Коронка для дерево 16 шт • [SL] Kronska žaga za les 16 kos • [EL] Κορώνα για την κοπή ξύλο 16 τεμ • [HR] 16-djelni set Krunske pile • [FR] Set Crown pour l'arbre • [IT] Imposta la corona per l'albero • [ES] Fiksu Kronon por la arbo [PT] Definir coroa para a árvore

Ø 19-127mm

HOLE CUTTERS:

Ø19, 22, 29, 32, 38, 44, 51, 64, 76, 89, 102, 127 mm



16 pcs



Art.No barcode
157710 3800123126000

HOLE CUTTERS Ø19-64MM 11 PCS KIT FOR WOOD

[BG] Боркорони 11 части комплект • [RO] 11Pcs/Set Freza gaurire • [SR] Krunska glava za bušenje na drvo 11kom • [MK] Круна за дрво 11ком • [RU] Набор Коронка для дерево 11 шт • [SL] Kronska žaga za les 11 kos • [EL] Κορώνα για την κοπή ξύλο 11 τεμ • [HR] 11-djelni set Krunske pile • [FR] Set Crown pour l'arbre • [IT] Imposta la corona per l'albero • [ES] Fiksu Kronon por la arbo • [PT] Definir coroa para a árvore

Ø 19-64mm

HOLE CUTTERS: Ø19, 22, 29, 32, 38, 44, 51, 64 mm

HOLESAWS:

Ø33, 53, 67, 73, 83mm



11 pcs



Art.No barcode
157707 3800123121203

HOLE CUTTERS Ø26-63MM 2" 7 PCS KIT FOR WOOD

[BG] Боркорони 7 части комплект • [RO] 7Pcs/Set Freza gaurire • [SR] Krunska glava za bušenje na drvo 7 kom • [MK] Круна за дрво 7 ком • [RU] Набор Коронка для дерево 7 шт • [SL] Kronska žaga za les 7 kos • [EL] Κορώνα για την κοπή ξύλο 7 τεμ • [HR] 7-djelni set Krunske pile • [FR] Set Crown pour l'arbre • [IT] Imposta la corona per l'albero • [ES] Fiksu Kronon por la arbo • [PT] Definir coroa para a árvore

Ø 26-63mm 2"

HOLE CUTTERS:

Ø26, 32, 38, 45, 50, 56, 63 mm



7 pcs



Art.No barcode
157704 3800123121197

BI-METAL HOLESAWS Ø22-64MM 9PCS KIT

[BG] Боркорони биметални 9 части комплект • [RO] 9Pcs/Set freze gaurire • [SR] Krunska glava za bušenje set 9kom [MK] Круна за дрво 9ком • [RU] Набор Биметаллическая Коронка 9 шт • [SL] Kronska žaga 9 kos • [EL] Κορώνα για την κοπή ξύλο 9 τεμ • [HR] 9-djelni set Krunske pile Bi-Metal • [FR] Ensemble de couronne bimétallique • [IT] Set corona bimetallica • [ES] Bimetala Krono • [PT] Conjunto de coroa bimetalica

Ø 22-64mm

HOLESAWS:

Ø22, 35, 38, 44, 51, 64 mm



9 pcs



Art.No barcode
157712 3800123160011

HOLESAW FOR CERAMICS Ø33-83MM 7PCS. KIT

[BG] Боркорони биметални 7 части комплект • [RO] 9Pcs/Set freze gaurire • [SR] Krunska glava za bušenje set 7kom [MK] Круна за дрво 7 ком • [RU] Набор Биметаллическая Коронка 7 шт • [SL] Kronska žaga 7 kos • [EL] Κορώνα για την κοπή ξύλο 7 τεμ • [HR] 7-djelni set Krunske pile Bi-Metal • [FR] Ensemble de couronne bimétallique • [IT] Set corona bimetallica • [ES] Bimetala Krono • [PT] Conjunto de coroa bimetalica

Ø 33-83mm

HOLESAWS:

Ø22, 35, 38, 44, 51, 64 mm



7 pcs



Art.No barcode
157714 3800123115783

ADJUSTABLE HOLE CUTTER UP TO Ø90MM FOR TILES

[BG] Сврдно за плочки • [RO] Dispositive taiere circulara reglabil pana la 90mm • [SR] Burgija za bušenje na pločice • [MK] Бургија за плочки • [RU] Сверло для плитки • [SL] Sveder za keramične ploščice • [EL] Τρυπάνι για την κοπή κεραμικά πλακίδια • [HR] Svrldo za pločice • [FR] Perceuse • [IT] Trapano per piastrelle • [ES] Tile taladro • [PT] Broca de telha

Ø0-90mm

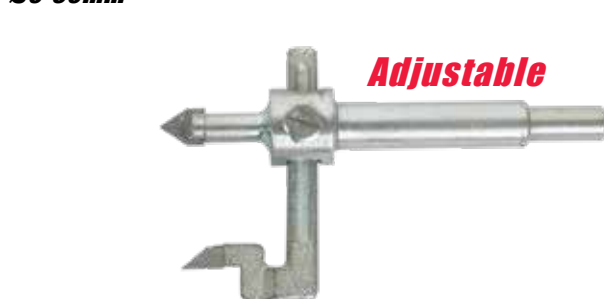

Art.No barcode
159908 3800123116490

HSS BI-METAL HOLESAW

[BG] Боркорона HSS bi-metal • [RO] Freze gaurire HSS bi-metal • [SR] Krunska glava za bušenje HSS bi-metal • [MK] Круна за дрво HSS bi-metal • [RU] Биметаллическая Коронка HSS bi-metal • [SL] Kronska žaga HSS bi-metal • [EL] Κορώνα για την κοπή ξύλο HSS bi-metal • [HR] Krunska svrdla HSS bi-metal • [FR] Couronne bimétallique HSS bi-métal • [IT] Bimetallic Crown HSS bi-metal • [ES] Bimetala Krono HSS bi-metal • [PT] Bimetálico Crown HSS bimetalico

Ø 20-83mm



art. №	Ø (mm)	barcode
157746	Ø20	3800123169083
157786	Ø22	3800123169496
157747	Ø25	3800123169090
157787	Ø30	3800123169502
157748	Ø32	3800123169106
157749	Ø35	3800123169113
157788	Ø40	3800123169519
157750	Ø44	3800123169120
157751	Ø51	3800123169137
157752	Ø57	3800123169144
157753	Ø65	3800123169151
157754	Ø68	3800123169168
157755	Ø76	3800123169175
157756	Ø83	3800123169182

HOLESAW ARBOR WITH PILOT MASONRY DRILL BIT

[BG] Водач за bi-метални боркорони с центриращо свредло • [RO] Burghiu de centrare cu zencuitor • [SR] Vodicica za kruna sa burgijja za centriranje • [MK] Водач за круна со центрирање вежба малку • [RU] Бур за колонковая бур фреза • [SL] Vodič za krona + sveder za centriranje • [EL] Οδηγός τρυπάνι • [HR] Adapter sa centrir svrdlom za krune • [FR] Fraise pour perceuse Kolonkovaya • [IT] Guida di perforazione • [ES] Borado Gvidilo • [PT] Guia de perfuração

1/2" (12.5 mm)

for Bi-Metal Holesaws Ø14-30mm



1/2"
(12.5mm)

Art.No	barcode
157800	3800123170065

HOLESAW ARBOR WITH PILOT MASONRY DRILL BIT

[BG] Водач за bi-метални боркорони с центриращо свредло • [RO] Burghiu de centrare cu zencuitor • [SR] Vodicica za kruna sa burgijja za centriranje • [MK] Водач за круна со центрирање вежба малку • [RU] Бур за колонковая бур фреза • [SL] Vodič za krona + sveder za centriranje • [EL] Οδηγός τρυπάνι • [HR] Adapter sa centrir svrdlom za krune • [FR] Fraise pour perceuse Kolonkovaya • [IT] Guida di perforazione • [ES] Borado Gvidilo • [PT] Guia de perfuração

5/8" (16 mm)

for Bi-Metal Holesaws Ø32-200mm



5/8"
(16mm)

Art.No	barcode
157757	3800123169199

COBALT PILOT DRILL BIT FOR BI-METAL HOLESAWS

[BG] Центриращо свредло Co за водач за bi-метални боркорони • [RO] Burghiu de centrare Co • [SR] Burgijja za centriranje Co • [MK] Центрирање вежба Co • [RU] Центрирующее Сверло Co • [SL] Sveder za centriranje Co • [EL] Ποτηροτρυπάνο ξύλου Co • [HR] Centrir svrdlom Co za krune • [FR] Foret de centrage • [IT] Centratore Drill • [ES] Centri Drill • [PT] Broca de Centralização



Art.No	barcode
157837	3800972002043

HSS BI-METAL HOLESAW 8% CO

[BG] Боркорона HSS bi-metal 8% Co • [RO] Freze gaurire HSS bi-metal 8% Co • [SR] Krunska glava za bušenje HSS bi-metal 8% Co • [MK] Круна за дрво HSS bi-metal 8% Co • [RU] Биметаллическая Коронка HSS bi-metal 8% Co • [SL] Kronska žaga HSS bi-metal 8% Co • [EL] Κορώνα για την κοπή ξύλο HSS bi-metal 8% Co • [HR] Krunska svrdla HSS bi-metal 8% Co • [FR] Couronne bimétallique HSS bi-métal 8% Co • [IT] Corona bimetallica HSS bi-metallo 8% Co • [ES] Bimetala Krono HSS bi-metallo 8% Co • [PT] Coroa bimetalica HSS bimetalica 8% Co

Ø 20-83mm



art. №	Ø (mm)	barcode
157820	Ø20	3800123173080
157821	Ø22	3800123173097
157822	Ø25	3800123173103
157823	Ø30	3800123173110
157824	Ø32	3800123173127
157825	Ø35	3800123173134
157826	Ø40	3800123173141
157827	Ø44	3800123173158
157828	Ø51	3800123173165
157829	Ø57	3800123173172
157830	Ø65	3800123173189
157831	Ø67	3800123173196
157832	Ø76	3800123173219
157833	Ø83	3800123173226

TUNGSTEN CARBIDE TIPPED HOLE SAW

[BG] Боркорона Carbide • [RO] Freze gaurire Carbide • [SR] Krunska glava za bušenje Carbide • [MK] Круна за дрво Carbide • [RU] Коронка Carbide • [SL] Kronska žaga Carbide • [EL] Κορώνα για την κοπή Carbide • [HR] Krunska svrdla Carbide • [FR] Couronne pour couper le carbure • [IT] Corona per taglio di carburo • [ES] Krono por trancado Carbide • [PT] Coroa para corte de carboneto

Ø 33-103mm

CARBIDE



art. №	Ø (mm)	barcode
157758	Ø33	3800123169205
157759	Ø43	3800123169212
157770	Ø53	3800123169335
157760	Ø67	3800123169229
157771	Ø73	3800123169342
157772	Ø83	3800123169359
157773	Ø103	3800123169366

CARBIDE HOLESAW ARBOR

[BG] Водач за Carbide боркорони • [RO] Arbore pentru carote Carbide • [SR] Vodilica za kruna Carbide [MK] Водач за круна Carbide • [RU] Центрирующий бур для буровые коронки • [SL] Vodič za kruna Carbide • [EL] Ποτηροτρήπανο ξύλου • [HR] Adapter za kruna Carbide • [FR] Déchiqueteuse de bois • [IT] Cippatrice • [ES] Cifona ligno • [PT] Triturador de madeira

Ø33-103mm



CARBIDE



Art.No barcode
157762 3800123169243

PILOT MASONRY DRILL BIT

[BG] Центриращо сверло за водач за Carbide боркорони • [RO] Burghiu de centrare • [SR] Burgija za centriranje • [MK] Центрирање вежба • [RU] Центрирующее Сверло • [SL] Sveder za centriranje • [EL] Ποτηροτρήπανο ξύλου • [HR] Centrir svrdlom za kruna • [FR] Foret de centrage • [IT] Centratore Drill • [ES] Centri Drill • [PT] Broca de Centralização

CARBIDE



Art.No barcode
157803 3800123173479

DIAMOND COATED HOLE SAW

[BG] Боркорона Diamond • [RO] Freze gaurire Diamond • [SR] Krunska glava za bušenje Diamond • [MK] Круна за дрво Diamond • [RU] Коронка Diamond • [SL] Krunska žaga Diamond • [EL] Κορώνα για την κοπή Diamond • [HR] Dijamantna krunska svrdla • [FR] Borkorona Diamond • [IT] Borkorona Diamond • [ES] Borkorona Diamond • [PT] Borkorona Diamond

Ø6-76mm



art. №	Ø mm	BARCODE
157774	Ø6	3800123169373
157775	Ø8	3800123169380
157776	Ø10	3800123169397
157777	Ø12	3800123169403
157778	Ø25 (1")	3800123169410
157779	Ø30 (1 1/8")	3800123169427
157780	Ø35 (1 3/8")	3800123169434
157781	Ø44 (1 3/4")	3800123169441
157782	Ø51 (2")	3800123169458
157783	Ø68	3800123169465
157784	Ø76 (3")	3800123169472



faience Ceramic

DRILL GUIDE HOLDER FOR DIAMOND COATED HOLE SAWS

[BG] Водач за диамантени боркорони • [RO] Ghid pentru carote diamantate • [SR] Vodič za dijaminske kruna za bušenje • [MK] Водич за диамантски боркорони • [RU] Руководство по алмазным коронкам • [SL] Vodnik za diamantne vrtnalnice kronami • [EL] Οδηγός για ποτηροκωνώνες με διαμάντια • [HR] Vodič za dijamentnim bušaćim krunama • [FR] Guide pour les fraises diamantées • [IT] Guida per corone diamantate • [ES] Guía para los cortadores de base del diamante • [PT] Guia para cortadores de núcleo do diamante

Ø4-83mm



Art.No barcode
157711 3800972002401

DIAMOND DRY HOLE SAW

[BG] Боркорона Diamond Dry • [RO] Carote diamantate pentru gaurire uscata • [SR] Krunska glava za bušenje diamond Dry • [MK] Круна за дрво Diamond Dry • [RU] Коронка Diamond Dry • [SL] Krunska žaga Diamond Dry • [EL] Κορώνα για την κοπή Diamond Dry • [HR] Dijamantna krunska svrdla Dry • [FR] Borkorona Diamond Dry • [IT] Borkorona Diamond Dry • [ES] Borkorona Diamond Dry • [PT] Borkorona Diamond Dry

RAIDER[®]
Pro



art. №	Ø mm	barcode
157838	Ø6	3800972014794
157839	Ø8	3800972014800
157840	Ø10	3800972014817
157841	Ø12	3800972014824
157842	Ø18	3800972014831
157843	Ø20	3800972014848
157844	Ø22	3800972014855
157845	Ø25	3800972014862
157846	Ø30	3800972014879
157847	Ø35	3800972014886
157848	Ø40	3800972014893
157849	Ø50	3800972014909
157850	Ø65	3800972014916



faience Ceramic

DIAMOND CUTTING DISC DRY

[BG] Диск диамантен DRY • [RO] Disc diamantat segmentat DRY • [SR] Rezna ploča dijaminska DRY • [MK] Диамантски диск • [RU] Абразивный круг диаманта DRY • [SL] Diamantna rezalna plošča DRY • [EL] Κύκλοι κοπής διαμαντιών DRY • [HR] Dijamantne ploče DRY • [FR] Disque de coupe le diamant • [IT] Diamond Disco da taglio • [ES] Tranča disko • [PT] Diamond Disco de corte

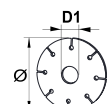

art. №	model	Ø (mm)	D1 (mm)	barcode
162101	DD01	115	22.2 (20)	3800123126123
162104	DD02	125	22.2 (20)	3800123126390
162124	-	85	10	3800972022669
162107	DD03	180	22.2 (25.4)	3800123126406
162110	DD04	230	22.2 (25.4)	3800123126482

granite

DIAMOND CUTTING DISC TURBO

[BG] Диск диамантен TURBO • [RO] Disc diamantat segmentat • [SR] Rezna ploča dijaminska TURBO • [MK] Диамантски диск T • [RU] Абразивный круг диаманта TURBO • [SL] Diamantna rezalna plošča TURBO • [EL] Κύκλοι κοπής διαμαντιών • [HR] Dijamantne ploče • [FR] Disque de coupe le diamant TURBO • [IT] Diamond Disco da taglio TURBO • [ES] Tranča disko • [PT] Diamond Disco de corte TURBO

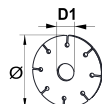

art. №	model	Ø (mm)	D1 (mm)	barcode
162102	DD05	115	22.2 (20)	3800123126444
162105	DD06	125	22.2 (20)	3800123126451
162108	DD07	180	22.2 (25.4)	3800123126468
162111	DD08	230	22.2 (25.4)	3800123126499

DIAMOND CUTTING DISC TURBO SUPER THIN

[BG] Диск диамантен TURBO ТЪНЪК [RO] Disc diamantat segmentat SUBȚIRE • [SR] Rezna ploča dijamantska TURBO TUNŪK • [MK] Дијамантски диск • [RU] Абразивный круг диаманта TURBO • [SL] Diamantna rezalna plošča TURBO • [EL] Κύκλοι κοπής διαμαντιών • [HR] Dijamantne ploče • [FR] Disque de coupe le diamant TURBO • [IT] Diamond Disco da taglio TURBO • [ES] Tranča disko • [PT] Diamond Disco de corte TURBO

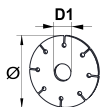

art. №	model	Ø (mm)	D1 (mm)	barcode
162201	DD21	115	22.2 (20)	3800972016415
162202	DD22	125	22.2 (20)	3800972016422

DIAMOND CUTTING DISC WET

[BG] Диск диамантен WET • [RO] Disc diamantat segmentat WET • [SR] Rezna ploča dijamantska WET • [MK] Дијамантски диск WET • [RU] Абразивный круг диаманта WET • [SL] Diamantna rezalna plošča WET • [EL] Κύκλοι κοπής διαμαντιών WET • [HR] Dijamantne ploče WET • [FR] Disque de coupe le diamant • [IT] Diamond Disco da taglio • [ES] Tranča disko • [PT] Diamond Disco de corte

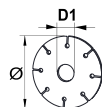

art. №	model	Ø (mm)	D1 (mm)	barcode
162121	CS24	85	10	3800123166136
162123	CS25	110	20	3800123167577
162103	DD09	115	22.2 (20)	3800123126413
162106	DD10	125	22.2 (20)	3800123126420
162109	DD11	180	22.2 (25.4)	3800123126437
162116	DD16	200	22.2 (25.4)	3800123127472
162112	DD12	230	22.2 (25.4)	3800123126611
162117	DD17	300	25.4	3800123127489

DIAMOND GRINDING HEAD

[BG] Диск диамантен за шлайфване на бетон • [RO] Disc oala ptr slefuit beton • [SR] Brusna ploča dijamantska • [MK] Дијамантски диск за брусење на бетон • [RU] Абразивный круг диаманта • [SL] Diamantna brusna plošča • [EL] Κόφτες διαμαντιών προφίλ για την πέτρα • [HR] Dijamantna brusna ploča • [FR] Tête de broyage le diamant • [IT] Testa di macinazione • [ES] Muelanta kapon • [PT] Diamond Disco cabeça de moagem



art. №	Ø (mm)	D1 (mm)	BARCODE
209931	125	22.2 (20)	3800123150678
209932	180	22.2	3800123150685

CUTTING DISC METAL

[BG] Диск за метал • [RO] Disc pentru taiat metal • [SR] Rezna ploča za metal • [MK] Диск за сечење на метал • [RU] Отрезной диск для резки металла • [SL] Rezalne plošče - kovina • [EL] Δίσκος κοπής μετάλλου • [HR] Ploča za rezanje metal • [FR] Disque de coupe en métal • [IT] Disco da taglio in metallo • [ES] Trančanta Diskon Metalo • [PT] Metal de disco de corte



art. №	Ø (mm)	D1 (mm)	D2 (mm)	BARCODE
160150	85	10	1.0	3800123166129
160118	115	22.2	1.0	3800123119538
160115	115	22.2	1.2	3800123113000
160106	115	22.2	1.6	3800123126314
160101	115	22.2	3.2	3800123126031
160119	125	22.2	1.0	3800123119545
160116	125	22.2	1.2	3800123113604
160117	125	22.2	1.6	3800123113611
160102	125	22.2	3.2	3800123126550
160113	150	22.2	3.2	3800123127274
160107	180	22.2	2.0	3800123126321
160103	180	22.2	3.2	3800123126048
160108	230	22.2	2.0	3800123126338
160104	230	22.2	3.2	3800123126086
160105	355	25.4	3.2	3800123126284

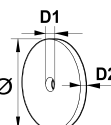

GRINDING DISC METAL

[BG] Диск за шлайфване • [RO] Disc abraziv • [SR] Brusna ploča za metal • [MK] Диск за брусење на метал • [RU] Диск шлифовальный по металлу • [SL] Plošče za brušenje - kovina • [EL] Δίσκος λείανσης των μετάλλων • [HR] Brusna ploča • [FR] Disque de meulage en métal • [IT] Disco abrasivo • [ES] Muelanta Diskon • [PT] Disco de moagem

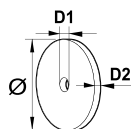

art. №	Ø (mm)	D1 (mm)	D2 (mm)	barcode
160109	115	22.2	6	3800123126604
160110	125	22.2	6	3800123126567
160111	180	22.2	6	3800123126574
160112	230	22.2	6	3800123126581



CUTTING DISC STONE

[BG] Диск за неметал • [RO] Disc taieri usoare-non metal • [SR] Rezna ploča • [MK] Диск за сечење • [RU] Отрезной диск • [SL] Rezalne plošče • [EL] Δίσκος κοπής • [HR] Ploča za rezanje cigli • [FR] Disque de coupe en pierre • [IT] Disco da taglio • [ES] Tranča Disko Štono • [PT] Pedra de disco de corte

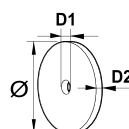

art. №	Ø (mm)	D1 (mm)	D2 (mm)	barcode
161101	115	22.2	3.2	3800123126307
161102	180	22.2	3.2	3800123126093
161103	230	22.2	3.2	3800123126109

CUTTING DISC METAL A60T INOX

[BG] Диск за метал A60T Inox • [RO] Disc pentru taiat metal A60T Inox • [SR] Rezna ploča za metal A60T Inox • [MK] Диск за сечење на метал • [RU] Отрезной диск для резки металла A60T Inox • [SL] Rezne plošče - kovina • [EL] Δίσκος κοπής μετάλλου • [HR] Ploča za rezanje metal A60T Inox • [FR] Disque de meulage en métal • [IT] Disco abrasivo • [ES] Muelanta Diskon • [PT] Disco de moagem

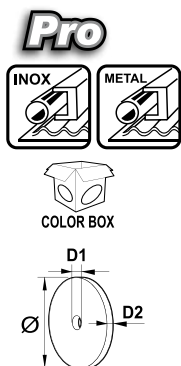

art. №	Ø (mm)	D1 (mm)	D2 (mm)	barcode
160120	115	22.2	1.0	3800123166471
160121	125	22.2	1.0	3800123166488

CUTTING DISC METAL

[BG] Диск за метал • [RO] Disc pentru taiat metal • [SR] Rezna ploča za metal • [MK] Диск за сечење на метал • [RU] Отрезной диск для резки металла • [SL] Rezne plošče - kovina • [EL] Δίσκος κοπής μετάλλου • [HR] Ploča za rezanje metal • [FR] Scie circulaire • [IT] Disco da taglio • [ES] Tranča Disko • [PT] Disco de corte

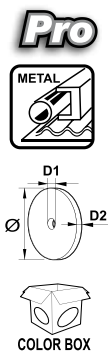

art. №	Ø (mm)	D1 (mm)	D2 (mm)	barcode
160122	115	22.2	2.5	3800123166495
160123	115	22.2	3.0	3800123166501
160152	125	22.2	1.0	3800972014633
160124	125	22.2	2.5	3800123166518
160125	125	22.2	3.0	3800123166525
160126	180	22.2	3.0	3800123166532
160127	230	22.2	2.0	3800123166549
160128	230	22.2	3.0	3800123166556
160129	350	25.4	3.5	3800123166563

GRINDING DISC METAL

[BG] Диск за шлайфане • [RO] Disc abraziv • [SR] Brusna ploča za metal • [MK] Диск за брусење на метал • [RU] Диск шлифовальный по металлу • [SL] Plošče za brušenje - kovina • [EL] Δίσκος λείανσης των μετάλλων • [HR] Brusna ploča • [FR] Disque de meulage en métal • [IT] Disco abrasivo • [ES] Muelanta Diskon • [PT] Disco de moagem

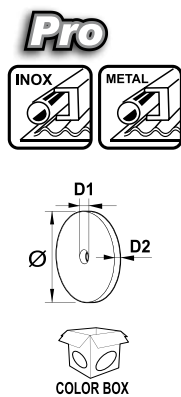

art. №	Ø (mm)	D1 (mm)	D2 (mm)	barcode
160144	115	22.2	6.0	3800123166570
160145	125	22.2	6.0	3800123166587
160146	180	22.2	6.0	3800123166594
160147	230	22.2	6.0	3800123166600

GRINDING DISC METAL

[BG] Диск за неметал • [RO] Disc taieri usoare-non metal • [SR] Rezna ploča • [MK] Диск за сечење [RU] Отрезной диск • [SL] Rezne plošče • [EL] Δίσκος κοπής • [HR] Ploča za rezanje cigli • [FR] Disque de coupe en pierre • [IT] Disco da taglio • [ES] Tranča Disko Štono • [PT] Pedra de disco de corte

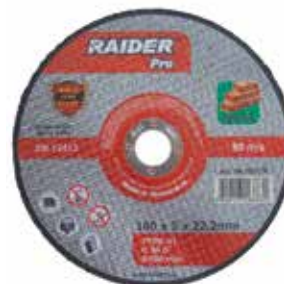
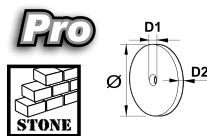

art. №	Ø (mm)	D1 (mm)	D2 (mm)	barcode
160134	115	22.2	3.0	3800123166617
160135	125	22.2	3.0	3800123166624
160136	180	22.2	3.0	3800123166631
160137	230	22.2	3.0	3800123166648

DISC FOR ANGLE GRINDER CARBIDE MULTI WHEEL

[BG] Диск за ъглошлайф Carbide Multi Wheel • [RO] Disc pentru polizor unghiular Carbide Multi Wheel • [SR] Disk za kutnu brusilicu Carbide Multi Wheel • [MK] Диск за мелење на агол Карбид Мулти тркало • [RU] Диск для угловой шлифовальной машины Carbide Multi Wheel • [SL] Disk za kotni brusilnik Carbide Multi Wheel • [EL] Κύκλοι κοπής διαμετρίων DRY • [HR] Dijamantne ploče DRY • [FR] Disque de coupe le diamant • [IT] Diamond Disco da taglio • [ES] Tranča diskó • [PT] Diamond Disco de corte

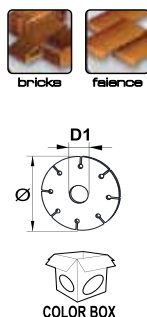

art. №	Ø (mm)	D1 (mm)	barcode
160153	115	22.2 (20)	3800972015234
160154	125	22.2 (20)	3800972015241

CIRCULAR SAW BLADE FOR ALUMINUM

[BG] Диск за циркуляр • [RO] Disc circular • [SR] List testere • [MK] Кружна Пила за Дрво • [RU] Циркулярный диск • [SL] List za krožno žago • [EL] Δίσκοπριον • [HR] Listova pila • [FR] Lame de scie circulaire • [IT] Lama per seghe circolari • [ES] Vidita klingo • [PT] Lâmina de serra circular



art. №	Ø (mm)	D1 (mm)	D1 (ring)	teeth (pcs)	barcode
163118	255	25.4	16/20	100	3800123160721

CIRCULAR SAW BLADE

[BG] Диск за циркуляр • [RO] Disc circular • [SR] List testere • [MK] Кружна Пила за Дрво • [RU] Циркулярный диск • [SL] List za krožno žago • [EL] Δίσκοτριβόνα • [HR] Listova pila • [FR] Lame de scie circulaire • [IT] Lama per seghe circolari • [ES] Vidita klingo • [PT] Lâmina de serra circular

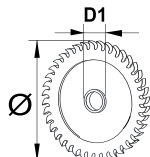

art. №	Ø (mm)	D1 (mm)	D1 (ring)	teeth (pcs)	BARCODE
163137	85	10	-	30	3800123166105
163138	85	10	-	80	3800123166112
163113	115	22.2	16	24	3800123126079
163134	115	22.2	16	36	3800123158247
163131	125	22.2	16	40	3800123141843
163106	160	20	16	24	3800123126628
163102	180	20	16	24	3800123126116
163128	185	20	16	24	3800123139420
163132	185	20	16	60	3800123141850
163135	190	20	16	24	3800123158810
163129	190	25.4	16	40	3800123139437
163136	190	20	16	80	3800123158827
163130	200	16	-	24	3800123139444
163104	210	25.4	16	24	3800123126635
163133	210	30	20	24	3800123143694
163115	210	30	25.4	60	3800123160004
163103	230	22.2	16	40	3800123126383
163116	250	30	25.4	48	3800123160707

163117	250	30	20	60	3800123160714
163114	254	25.4	16	60	3800123127953
163107	300	25.4	16	56	3800123126659
163110	300	30	20	56	3800123126949
163144	305	30	25.4	100	3800972010772
163126	315	30	20	40	3800123127496
163108	350	25.4	16	56	3800123126666
163111	350	30	20	56	3800123126956
163109	400	25.4	16	56	3800123126673
163112	400	30	20	56	3800123126963
163145	190	30	-	24	3800972019584
163146	190	30	-	36	3800972019591
163147	190	30	-	48	3800972019607
163148	190	30	-	60	3800972019614
163149	200	30	-	24	3800972019621
163150	210	30	-	48	3800972019638
163151	254	30	-	40	3800972019645
163152	254	30	-	80	3800972019652

FLAP DISC

[BG] Диск ламелен • [RO] Disc ptr slefuit • [SR] Brusni papir lamelni • [MK] Ламинарен абразивен диск • [RU] Плита диска • [SL] Lamelna brusilna plošča • [EL] Δίσκοι με πτερύγια από χαρτί λείανσης • [HR] Lamelirane brusne ploče • [FR] Plaques de meulage lamellaires • [IT] Piastre di macinazione lamellare • [ES] Lamellar muelanta telerojn • [PT] Placas de moagem lamelar

EN 13743

art. №	Ø1 (mm)	Ø2 (mm)	A	barcode
164112	115	22	A-40	3800123127298
164102	115	22	A-60	3800123126352
164103	115	22	A-80	3800123126369
164104	115	22	A-100	3800123126376
164105	115	22	A-120	3800123126543
164113	115	22	A-150	3800123150746
164118	125	22	A-40	3800123151095
164119	125	22	A-60	3800123151101
164120	125	22	A-80	3800123151118
164121	125	22	A-100	3800123151125
164122	125	22	A-120	3800123151132
164123	125	22	A-150	3800123151149



FLAP WHEEL BURNISHING MOP FOR POWER DRILL

[BG] Диск за сваляне на ръжда за бормашина • [RO] Perie segmentata smirghel-cu tija • [SR] Brusna lepeza • [MK] Абразивен диск за бормашина • [RU] Дрель и лепестковая шлифовальная насадка • [SL] Lamelasti kolut na osovini • [EL] Πολύπτερο γυαλόχαρτο • [HR] Lepezasti brusni kolut • [FR] Disque pour enlever la rouille • [IT] Disco per rimuovere la ruggine • [ES] Disko por forigi ruston • [PT] Disco para remoção de ferrugem

Ø 64mm

Art.No barcode
209920 3800123127625

WIRE WHEEL BRUSH BRASSED WITH SHANK

[BG] Четка за бормашина плоска месинг • [RO] Perie sarma cu tija ptr bormasina • [SR] Četka čelična gavna mesing • [MK] Жичана Челична Четка • [RU] Стальная латунированная волнистая проволока • [SL] Žična ščetka • [EL] Συρμιότινη βούρτσα τροχού • [HR] Plosnata žičana četka - valovita žica • [FR] Brosse de forage • [IT] Pennello da trapano • [ES] Cepillo de taladro • [PT] Escova de perfuração



art. №	Ø (mm)	barcode
170104	50 (2")	3800123102073
170105	75 (3")	3800123102080
170106	100 (4")	3800123102097

TWIST KNOT WIRE WHEEL BRUSH WITH SHANK

[BG] Четка за бормашина плоска плетена • [RO] Perie circulara rotativa • [SR] Četka čelična gavna upletena • [MK] Жичана Челична Четка (Увртена) • [RU] Стальная переплетенная щетка • [SL] Lončasta ščetka - pletena žica • [EL] Πομπροειδής βούρτσα - πλεγμένο σύρμα • [HR] Plosnata žičana četka - pletena • [FR] Brosse de forage • [IT] Pennello da trapano • [ES] Cepillo de taladro • [PT] Escova de perfuração

Ø 75mm (3")

Art.No barcode
170108 3800123163678

WIRE CUP BRUSH BRASSED WITH SHANK

[BG] Четка за бормашина камбана месинг • [RO] Perie sarma rotativa • [SR] Četka čelična kružna mesing • [MK] Жичана Челична Четка • [RU] Щетка чашки волнистой • [SL] Žična ščetka • [EL] Συρμάτινη βούρτσα τροχού • [HR] Lončasta žičana četka za bušilice - valovita žica • [FR] Brosse de perceuse en laiton • [IT] Spazzola per trapano in ottone • [ES] Drilo Broso • [PT] Escova de broca de latão



art. №	Ø (mm)	barcode
170101	50 (2")	3800123102042
170102	75 (3")	3800123102059
170103	100 (4")	3800123102066



TWIST KNOT WIRE CUP BRUSH WITH SHANK FOR RDP-CDLO1

[BG] Четка за бормашина камбана плетена • [RO] Perie sarma rotativa pentru masina de gaurit • [SR] Četka čelična kružna za bušilica • [MK] Жичана челична четка за бормашина • [RU] Щетка чашки волнистой за дрель • [SL] Žična ščetka za udarni vrtalnik • [EL] Συρμάτινη βούρτσα τροχού για κρουστικό δρπαπανο • [HR] Ravna žičana četka • [FR] Brosse de forage • [IT] Pennello da trapano • [ES] Cepillo de taladro • [PT] Escova de perfuração



Ø 25mm (1")



Art.No	barcode
170107	3800123163661

TWIST KNOT WIRE CUP BRUSH WITH SHANK

[BG] Четка за бормашина камбана плетена • [RO] Perie sarma rotativa pentru masina de gaurit • [SR] Četka čelična kružna za bušilica • [MK] Жичана челична четка за бормашина • [RU] Щетка чашки волнистой за дрель • [SL] Žična ščetka za udarni vrtalnik • [EL] Συρμάτινη βούρτσα τροχού για κρουστικό δρπαπανο • [HR] Ravna žičana četka • [FR] Brosse de forage • [IT] Pennello da trapano • [ES] Cepillo de taladro • [PT] Escova de perfuração

Ø 75mm (3")



Art.No	barcode
170109	3800123163685

BRASS-COATED WIRE WHEEL BRUSH FOR ANGLE GRINDER

[BG] Телена четка с месингово покритие за ъглошлифайф • [RO] Perie roată din sârmă acoperită cu alamă pentru polizor unghiular • [SR] Žičana četka za ugaone brusilice presvučena mesingom • [MK] Четка за тркала со жица обложена со месинг за аголна мелница • [RU] Проволочная колесная щетка с латунным покрытием для угловой шлифовальной машины • [SL] Z medenino prevlečena žična ščetka za kotni brusilnik • [EL] Συρμάτινη βούρτσα τροχού με επικάλυψη ορείχαλκου για γωνιακό μύλο • [HR] Žičana četka presvučena mesingom za kutnu brusilicu • [FR] Brosse circulaire métallique revêtue de laiton pour meuleuse d'angle • [IT] Spazzola a disco in ottone per smerigliatrice angolare • [ES] Cepillo circular de alambre revestido de latón para amoladora angular • [PT] Escova de roda de arame revestida de latão para rebarbadora



Art.No	barcode
171123	3800972025233
171124	3800972025240
171125	3800972025257
171126	3800972025264
171127	3800972025271
171128	3800972025288
171129	3800972025295

TWIST KNOT WIRE WHEEL BRUSH FOR ANGLE GRINDER

[BG] Четка телена за ъглошлифайф плоска плетена • [RO] Wist Knot Wire Wheel Perie pentru polizor unghiular • [SR] Vist Knot Vire Vheel Četka za ugaonu brusilicu • [MK] Wist Knot Wire Wheel четка за аголна мелница • [RU] Wist Knot Wire Wheel Brush для угловой шлифовальной машины • [SL] wist žična ščetka za kotni brusilnik • [EL] Wist Knot Wire Wheel Brush for Angle Grinder • [HR] wist žičana četka za kutnu brusilicu • [FR] wist Knot Wire Wheel Brush pour meuleuse d'angle • [IT] Wist Knot Spazzola a disco per smerigliatrice angolare • [ES] Cepillo de rueda de alambre con nudo para amoladora angular • [PT] Escova de roda de arame wist Knot para rebarbadora



Art.No	barcode
171108	3800123102172
171109	3800123102189
171110	3800123102288

WIRE CUP BRUSH BRASSED FOR ANGLE GRINDER

[BG] Четка за ъглошлифайф камбана месинг • [RO] Set 20 buc perii sarma pentru bormasina • [SR] Četka čelična kružna mesing • [MK] Жичана Челична Четка • [RU] Щетка чашки волнистой • [SL] Žična ščetka • [EL] Συρμάτινη βούρτσα τροχού • [HR] Lončasta žičana četka - valovita žica • [FR] Brosse d'angle • [IT] Spazzola smerigliatrice angolare • [ES] Cepillo de amoladora angular • [PT] Escova de rebarbadora



art. №	Ø (mm)	barcode
171103	75	3800123102103
171106	100	3800123102110
171121	125	3800123151248



COLOR BOX

TWIST KNOT WIRE CUP BRUSH FOR ANGLE GRINDER

[BG] Четка за ъглошлайф камбана плетена • [RO] Set 3 buc perii sarma pentru bormasina
 • [SR] Četka čelična kružna upletena • [MK] Жичана Челична Четка (Увртена) • [RU] Стальная переплетенная щетка • [SL] Lončasta ščetka – pletena žica • [EL] Ποτρωειδής βούρτσας – πλεγμένο σύρμα • [HR] Lončasta žičana četka- pletena čelična žica • [FR] Brosse d'angle • [IT] Spazzola smerigliatrice angolare • [ES] Cepillo de amoladora angular • [PT] Escova de rebarbadora



art. №	Ø (mm)	barcode
171101	75	3800123102127
171104	100	3800123102134
171107	125	3800123102141



COLOR BOX

TWIST KNOT WIRE CUP BRUSH HEAVY DUTY FOR ANGLE GRINDER

[BG] Четка за ъглошлайф камбана плетена усилена • [RO] Perie sarma rotativa • [SR] Četka čelična kružna upletena • [MK] Жичана Челична Четка (Увртена) • [RU] Стальная переплетенная щетка • [SL] Lončasta ščetka – pletena žica • [EL] Ποτρωειδής βούρτσας – πλεγμένο σύρμα • [HR] Lončasta žičana četka- pletena čelična žica • [FR] Brosse d'angle • [IT] Spazzola smerigliatrice angolare • [ES] Cepillo de amoladora angular • [PT] Escova de rebarbadora



art. №	Ø (mm)	barcode
171102	75	3800123102158
171105	100	3800123102165



COLOR BOX

BRASS-COATED WIRE CONICAL BRUSH FOR ANGLE GRINDER M 14

[BG] Четка за ъглошлайф камбана месинг • [RO] Set 20 buc perii sarma pentru bormasina • [SR] Četka čelična kružna mesing • [MK] Жичана Челична Четка [RU] Щетка чашки волнистой [SL] Žična ščetka • [EL] Συρμάτινη βούρτσας τροχού • [HR] Lončasta žičana četka- valovita žica • [FR] Brosse d'angle • [IT] Spazzola smerigliatrice angolare • [ES] Cepillo de amoladora angular • [PT] Escova de rebarbadora



art. №	Ø (mm)	barcode
171130	115	3800972025851
171131	125	3800972025868



COLOR BOX

TWIST KNOT WIRE SAUCER CUP BRUSH FOR ANGLE GRINDER

[BG] Четка за ъглошлайф конусна плетена • [RO] Perie sarma rotativa • [SR] Četka čelična kružna upletena • [MK] Жичана Челична Четка (Увртена) • [RU] Стальная переплетенная щетка • [SL] Lončasta ščetka – pletena žica • [EL] Ποτρωειδής βούρτσας – πλεγμένο σύρμα • [HR] Plosnata žičana četka • [FR] Brosse d'angle • [IT] Spazzola smerigliatrice angolare • [ES] Cepillo de amoladora angular • [PT] Escova de rebarbadora

Ø 100mm



Art.No	barcode
171122	3800123163630



COLOR BOX

WIRE WHEEL BRUSH BRASSED FOR BENCH GRINDER

[BG] Четка за шмиргел месинг • [RO] Perie circulara din sarma • [SR] Četka čelična za oštrač mesing • [MK] Жичана Челична Четка за струг месинг • [RU] Щетка волнистой проволоки круговая • [SL] Žične ščetke za dvojno brusilno paravo • [EL] Ποτρωειδής βούρτσας • [HR] Plosnata žičana četka- valovita žica • [FR] Brosse en laiton • [IT] Pennello in ottone • [ES] Cepillo de latón • [PT] Escova para lixadeira



art. №	Ø (mm)	barcode
172101	125 (5")	3800123102196
172102	150 (6")	3800123102202
172103	200 (8")	3800123102219



COLOR BOX

PLASTIC BRUSHES Ø50H26 Ø100H26 Ø90H90MM WITH HEX SHANK 1/4" 3PCS. SET

[BG] Четки за бормашина и винтоверт • [RO] Perii din plastic • [SR] Plastične četke • [MK] Пластични четки • [RU] Пластиковые щетки • [SL] Plastične ščetke • [EL] Πλαστικές βούρτσες • [HR] Plastične četke • [FR] Brosses en plastique • [IT] Spazzole di plastica • [ES] Cepillos de plástico • [PT] Escovas de plástico

3pcs



Art.No	barcode
170113	3800972024403

WIRE BRUSHES BRASSED WITH SHANK 3 PCS SET

[BG] Четки за бормашина месинг 3 бр. комплект • [RO] 3 Pcs/Set perii sarma ptr bormasina
 • [SR] Četka čelična set 3 kom • [MK] Жичана Челична Четка сет 3 ком месинг • [RU] Щетка
 волнистой проволоки круговая набор 3 шт. • [SL] Žične ščetke 3 kos • [EL] Ποητροειδής βούρτσας
 Σετ 3 τεμάχια • [HR] Čelične žičane četke 3 kom. • [FR] Brosses pour perceuse en laiton 3 pcs. kit
 • [IT] Spazzole per trapano in ottone 3 pz. set • [ES] Cepillos para taladro de latón 3 uds. kit • [PT]
 Escovas para broca de latão 3 peças. kit

3pcs



Art.No barcode
177101 3800123102240



Art.No barcode
177103 3800123102264

SANDING SHEETS FOR SANDER WITH 8 HOLES 10PCS

[BG] Шкурка за виброшлайф с 8 отвора 10бр • [RO] Set 10 buc banda smirghel perforate • [SR]
 Brusni papir 10 kom • [MK] Абразивна Хартија 10 ком • [RU] Бумага наждачная 10 шт. • [SL]
 Brusni platna 10 kos • [EL] Γυαλόχαρτο Σετ 10 τεμάχια • [HR] Brusni papir 10 kom. • [FR] Ponceuse
 pour broyeur vibrant 10 pcs. • [IT] Levigatrice per smerigliatrice vibrante 10 pz. • [ES] Lijadora para
 amoladora vibratoria 10 uds. • [PT] Lixadeira para moedor vibratório 10 pcs.

10pcs / 8holes

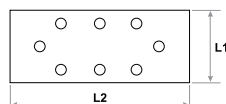

art. №	L1 (mm)	L2 (mm)	P	barcode
180101	93	230	P60	3800123135446
180112	93	230	P80	3800123150555
180102	93	230	P100	3800123135453
180103	93	230	P120	3800123135460
180113	93	230	P150	3800123150562
180104	93	230	P180	3800123135477
180105	93	230	P240	3800123135484
180114	115	280	P40	3800123150579
180106	115	280	P60	3800123135491
180115	115	280	P80	3800123150586
180107	115	280	P100	3800123135507
180108	115	280	P120	3800123135514
180116	115	280	P150	3800123150593
180109	115	280	P180	3800123135521
180110	115	280	P220	3800123135538

SANDING BELTS FOR BELT SANDER 5 PCS

[BG] Шкурка за лентов шлайф 5 броя • [RO] Set 5 buc banda smirghel • [SR] Brusna traka Set
 5 kom • [MK] Абразивна Трака 5 ком • [RU] Лента для шлифмашины 5 шт. • [SL] Brusni trakovi
 kovina 5 kos • [EL] Ιμαντες λειανσης 5 τεμάχια • [HR] Brusna traka za Tračne brusilice 5 kom • [FR]
 Papier abrasif pour 5 meuleuses à bande • [IT] Carta abrasiva per 5 smerigliatrici a nastro • [ES]
 Papel de lija para 5 amoladoras de cinta • [PT] Lixa para 5 moedores de correia

5pcs



art. №	mm	P	BARCODE
183111	75x457	P40	3800123135170
183112	75x457	P60	3800123135187
183113	75x457	P80	3800123135194
183114	75x457	P100	3800123135200
183115	75x457	P120	3800123135224
183106	75x533	P40	3800123135996
183107	75x533	P60	3800123136009
183108	75x533	P80	3800123136207
183109	75x533	P100	3800123135156
183110	75x533	P120	3800123135163

PAPER SANDING DISCS VELCRO 10 PCS.

[BG] Шкурка VELCRO • [RO] Hârtie abrazivă VELCRO • [SR] Brusni papir VELCRO [MK] Шкурка
 VELCRO • [RU] Наждачная бумага на липучке • [SL] Brusni papir VELCRO • [EL] Γυαλόχαρτο
 VELCRO • [HR] Brusni papir VELCRO • [FR] Papier de verre VELCRO • [IT] Carta vetrata VELCRO
 • [ES] Papel de lija VELCRO • [PT] Lixa VELCRO



art. №	mm	P	barcode
180702	Ø115	K40	3800123134906
180703	Ø115	K60	3800123134913
180704	Ø115	K80	3800123134920
180705	Ø115	K100	3800123134937
180706	Ø115	K120	3800123134944
180731	Ø 125	P40	3800972025158
180732	Ø 125	P60	3800972025165
180733	Ø 125	P80	3800972025172
180734	Ø 125	P100	3800972025189
180735	Ø 125	P120	3800972025196



SANDING DISCS FOR RANDOM ORBIT SANDER WITH 8 HOLES 10PCS

[BG] Шкурка за ексцентършлайф с 8 отвора 10 бр • [RO] Set 10 buc banda smirghel slefuitor
 circular • [SR] Brusni papir 10 kom • [MK] Абразивна Хартија 10 ком • [RU] Бумага наждачная
 10 шт. • [SL] Brusni platna 10 kos • [EL] Γυαλόχαρτο Σετ 10 τεμάχια • [HR] Brusni papir za
 Ekscentrične brusilice 10 kom • [FR] Disques de ponçage pour ponceuse à orbite aléatoire avec 8
 trous 10pcs • [IT] Dischi abrasivi per levigatrice orbitale casuale con 8 fori 10 pezzi • [ES] Discos de
 lijar para lijadora de órbita aleatoria con 8 orificios 10pcs • [PT] Discos de lixamento para lixadeira
 de órbita aleatória com 8 furos 10pcs

10pcs / 8holes

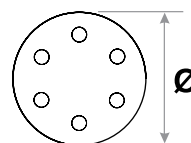

art. №	Ø (mm)	P	barcode
181101	125	K60	3800123135545
181102	125	K120	3800123135552
181103	125	K180	3800123135569
181104	125	K240	3800123135576

PAPER SANDING DISCS VELCRO WITH 6 HOLES 10PCS

[BG] Шкурка VELCRO с 6 отвора 10 бр. • [RO] Set 10 buc banda circulara smirghel • [SR] Brusni papir lepezasti • [MK] Абразивна Хартија VELCRO 10 ком • [RU] Бумага наждачная 10 шт. • [SL] Brusni platna 10 kos • [EL] γυαλόχαρτο Σετ 10 τεμάχια • [HR] Brusni papir VELCRO 10 kom • [FR] Disques à poncer VELCRO 10pcs • [IT] Dischi abrasivi per carta VELCRO 10 pezzi • [ES] Discos de lija de papel VELCRO 10 piezas • [PT] Discos de lixamento de papel VELCRO 10pcs



10pcs / 6holes



art. №	Ø (mm)		barcode
180713	150	K60	3800123165412
180714	150	K80	3800123165429
180715	150	K100	3800123165436
180716	150	K120	3800123165443
180717	150	K150	3800123165450
180718	150	K180	3800123165467
180719	150	K220	3800123165474
180720	150	K240	3800123165481

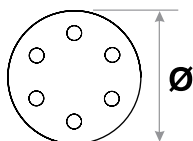

ABRASIVE FLAP WHEEL FOR POWER DRILL

[BG] Шкурка за бормашина ламелна • [RO] Perie segmentata smirghel • [SR] Brusni papir lepezasti • [MK] Ламинарен абразивен диск за бормашина • [RU] Диск лепестковый для дрели • [SL] Pah|jačasti brusilnik • [EL] Γυαλόχαρτα κυλινδρική με άξονα • [HR] Lepezasti brusni čerovi • [FR] Roue à lamelles abrasive pour perceuse • [IT] Ruota lamellare abrasiva per trapano elettrico • [ES] Abrasive flap rado por potencia drilo [PT] Roda de aba abrasiva para furadeira



art. №	Ø (mm)		barcode
183501	50	K60	3800123135712
183502	50	K120	3800123135729
183503	60	K60	3800123135736
183504	60	K120	3800123135743
183505	80	K60	3800123135750
183506	80	K120	3800123135767



DRYWALL PLASTER SANDING SCREEN 5 PCS

[BG] Шкурка мрежа от силициев карбид 5 бр. • [RO] Set 5 buc rezerva bagheta silicon • [SR] Brusni papir 5 kom • [MK] Абразивна Хартија 5 ком • [RU] Латекса абразивной бумага карбида 5 шт. • [SL] Brusni platna 5 kos • [EL] Σιλεροχαρτο Σετ 5 τεμ • [HR] Brusna mreža silicij karbid • [FR] Écran de ponçage de plâtre pour cloisons sèches 5 PC • [IT] Rete di carta vetrata 5 pezzi • [ES] Reto de rekta flugo 5pcs • [PT] Rede de lixa 5 pcs

5pcs / 93x230mm

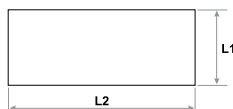

art. №	L1 (mm)	L2 (mm)		barcode
184101	93	230	P40	3800123150609
184102	93	230	P60	3800123150616
184103	93	230	P80	3800123150623
184104	93	230	P100	3800123150630
184105	93	230	P120	3800123150647
184106	93	230	P150	3800123150654



SANDING SPONGE

[BG] Гъба абразивна • [RO] Burete smirghel • [SR] Sunder za brušenje • [MK] Абразивен сунѓер • [RU] Абразивная губка • [SL] Gobice za ročno brušenje • [EL] Λειαντικά Σφουγγάρια • [HR] Brusna spužva • [FR] Éponge de ponçage • [IT] Spugna abrasiva • [ES] Sanding-Spongo • [PT] Esponja de lixamento

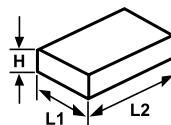

art. №	L1 (mm)	L2 (mm)	H (mm)	P	barcode
189101	70	100	25	P40	3800123136269
189102	70	100	25	P60	3800123136276
189103	70	100	25	P80	3800123136283
189104	70	100	25	P100	3800123136290
189105	70	100	25	P120	3800123136306
189106	70	100	25	P150	3800123136313

ADAPTERS SET 1/4" HEX TO 1/4", 3/8", 1/2" SQUARE 3 PCS.

[BG] Адаптери 3 броя комплект • [RO] Set 3 buc adaptor • [SR] Adapter 3 komada set • [MK] Адаптер 3 парчиња комплект • [RU] Переходник 3 шт набор • [SL] Adapter 3 kosi komplet • [EL] Προσαρμογέας σετ 3 τεμαχίων • [HR] Adapteri 3 komada set • [FR] Kit de 3 adaptateurs • [IT] Adattatori Kit da 3 pezzi • [ES] Adaptiloj 3 pecoj kit • [PT] Kit de 3 peças para adaptadores

1/4" HEX to
1/4", 3/8", 1/2" SQ



Art.No	barcode
158904	3800123173486

SCREWDRIVER BITS 1/4" 29 PCS SET

[BG] Накрайници 29 броя комплект • [RO] Set biti 29 buc • [SR] Pin Set 29 kom • [MK] Битови, Сет 29 Пар • [RU] Набор бит 29 шт • [SL] Set bit-nastavkov 29-delni komplet • [EL] Σετ μύτες 29 τεμαχίων σε κασετίνα • [HR] Set bitovi 29 kom • [FR] Embouts de tournevis 1/4 "29 pièces • [IT] Set di cacciaviti 1/4 "Set 29 pezzi • [ES] Destornillataj Bitoj 1/4 "29 Pcs-Aro • [PT] Chave de fenda 1/4 "29 Pcs Set

29pcs

pcs	Name	Sizing
24	25mm(L) BIT	<ul style="list-style-type: none"> 3PC SLOTTED: 3, 4, 5, 6, 7 mm 3PC PHILLIPS: PH1, PH2, PH3 3PC POZI: PZ1, PZ2, PZ3 4PC METRIC HEX: H3, H4, H5, H6 3PC SQUARE: #1, #2, #3 6PC STAR: T10, T15, T20, T25, T27, T30
2	SCREWDRIVER BIT	50 mm
1	COMPACT SCREW GUIDE	80 mm Long
2	MAGNETIC NUT SETTER	6,8 mm



1/4"



Art.No	barcode
157792	3800123169571

SCREWDRIVER BITS 1/4" 37 PCS SET

[BG] Накрайници 37 броя комплект • [RO] Set biti 37 buc • [SR] Pin Set 37 kom • [MK] Битови, Сет 37 Пар • [RU] Набор бит 37 шт • [SL] Set bit-nastavkov 37-delni komplet • [EL] Σет μύτες 37 τεμαχίων σε κασετίνα • [HR] Set bitovi 37 kom • [FR] Embouts de tournevis 37 pièces • [IT] Set di cacciaviti 37 pezzi • [ES] Destornillataj [FR] Embouts de tournevis 37 pièces • [IT] Set di cacciaviti 37 pezzi • [ES] Destornillataj Bitoj 37 Pcs-Aro • [PT] Chave de fenda 37 Pcs Set Bitoj

pcs	Name	Sizing
8	50 mm (L) BIT	<ul style="list-style-type: none"> 2PC SLOTTED: 5.5, 8 mm 3PC PHILLIPS: PH1, PH2, PH3 3PC POZI: PZ1, PZ2, PZ3
24	25 mm(L) BIT	<ul style="list-style-type: none"> 5PC SLOTTED: 3, 4, 5, 6, 7mm 3PC PHILLIPS: PH1, PH2, PH3 3PC POZI: PZ1, PZ2, PZ3 4PC METRIC HEX: H3, H4, H5, H6 3PC SQUARE: #1, #2, #3 6PC STAR: T10, T15, T20, T25, T27, T30
4	NUT DRIVER	5, 6, 8, 10 mm
1	BIT HOLDER	

37pcs



Art.No barcode
157793 3800123169588

SCREWDRIVER BITS & DRILL BITS 1/4" 15 PCS SET

[BG] Накрайници и свердла 1/4" 15 броя комплект • [RO] Set burghie si biti 15 buc • [SR] Pinovi i Burghije Set 15 kom • [MK] Битови и Бургии, Сет 15 Пар • [RU] Набор бит и сверл 15 шт • [SL] 15-delni set svedri in vijačni nastavki • [EL] Σет μύτες τρυπάνια 15 τεμαχίων • [HR] SET bitovi i svrdla 15 kom • [FR] Embouts de tournevis et embouts 1/4 "15 pièces • [IT] Giraviti e punte da trapano Set da 1/4 "15 pezzi • [ES] Disilador Bits & Drill Bits 1/4 "15 komputiloj • [PT] Chave de fendas e brocas 1/4 "15 peças

15pcs

pcs	Name	Sizing
7	HSS DRILL BITS WITH HEX SHANK	Ø1.5, 2.0, 3.0, 4.0, 4.5, 5.0, 6.0 mm
7	50mm (L) BIT	<ul style="list-style-type: none"> 2PC SLOTTED: 4, 5 mm 2PC PHILLIPS: PH2 x 2 2PC POZI: PZ2 x 2 1PC SQUARE: #2
1	MAGNETIC HOLDER	58 mm



Art.No barcode
157795 3800123169601

SCREWDRIVER BITS & DRILL BITS 1/4" 20 PCS SET

[BG] Накрайници и свердла 1/4" 20 броя комплект • [RO] Set burghie si biti 20 buc • [SR] Pinovi i burghije Set 20 kom • [MK] Битови и Бургии, Сет 20 Пар • [RU] Набор бит и сверл 20 шт • [SL] 20-delni set svedri in vijačni nastavki • [EL] Σет μύτες τρυπάνια 20 τεμαχίων • [HR] SET bitovi i svrdla 20 kom • [FR] Embouts de tournevis et embouts 1/4 "20 pièces • [IT] Giraviti e punte da trapano Set da 1/4 "20 pezzi • [ES] Disilador Bits & Drill Bits 1/4 "20 komputiloj • [PT] Chave de fendas e brocas 1/4 "20 peças

pcs	Name	Sizing
7	HSS DRILL BITS WITH HEX SHANK	Ø1.5, 2.0, 3.0, 4.0, 4.5, 5.0, 6.0 mm
9	50mm (L) BIT	<ul style="list-style-type: none"> 3PC SLOTTED: 4, 5, 6 mm 3PC PHILLIPS: PH1, PH2, PH3 3PC POZI: PZ1, PZ2, PZ3
3	NUT DRIVER	6, 8, 10mm
1	QUICK CHANGER	

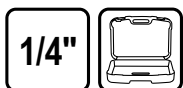

Art.No barcode
157797 3800123169625

SCREWDRIVER BITS & MAGNETIC HOLDER QUICK-CHANGE

[BG] Накрайници и магнитен държач бърз захват 1/4" 15 бр. к-т RAIDER • [RO] Set biti 15 buc • [SR] Pin Set 15 kom • [MK] Битови, Сет 15 пар • [RU] Набор бит 15 шт • [SL] Set bit-nastavkov 15-delni komplet • [EL] Σет μύτες 15 τεμαχίων σε κασετίνα • [HR] Set bitovi 1/4 "15 kom • [FR] Embouts de tournevis et support magnétique à changement rapide 1/4 "Set de 15 pièces • [IT] Set di cacciaviti e supporto magnetico Set rapido 1/4 "15 pezzi • [ES] Nozzles kaj magneta posedanto fastas 1/4 "15 komputilojn • [PT] Bicos e suporte magnético fixam 1/4 "15 peças

pcs	Sizing
14	25mm(L) BIT
	<ul style="list-style-type: none"> 3PC SLOTTED: 4, 5, 6 2PC PHILLIPS: PH1, PH2 2PC POZI: PZ1, PZ2 3PC HEX: 3, 4, 5 4PC T10, T15, T20, T30
1	ADAPTOR MAGNET QUICK RELEASE



1/4" 15 PCS. SET

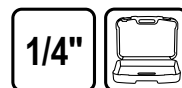

Art.No barcode
158903 3800123171703

SCREWDRIVER BITS & MAGNETIC HOLDER QUICK-CHANGE 1/4" 32 PCS. SET

[BG] Накрайници и магнитен държач бърз захват 1/4" 32 бр. к-т RAIDER • [RO] Set biti 32 buc • [SR] Pin Set 32 kom • [MK] Битови, Сет 32 пар • [RU] Набор бит 32 шт • [SL] Set bit-nastavkov 32-delni komplet • [EL] Σет μύτες 32 τεμαχίων σε κασετίνα • [HR] Set bitovi 1/4 "32 kom • [FR] Embouts de tournevis et support magnétique à changement rapide 1/4 "Set de 32 pièces • [IT] Set di cacciaviti e supporto magnetico Set rapido 1/4 "32 pezzi • [ES] Nozzles kaj magneta posedanto fastas 1/4 "32 komputilojn • [PT] Bicos e suporte magnético fixam 1/4 "32 peças

32pcs

pcs	Sizing
30	25mm(L) BIT
	<ul style="list-style-type: none"> 4PCS SLOTTED: 3, 4, 5, 6 4PCS PHILLIPS: PH1, PH2, PH3, PH4 4PCS POZI: PZ1, PZ2, PZ3, PZ4 4PCS HEX: 3, 4, 5, 6mm 7PCS T10, T15, T20, T25, T27, T30, T40 7PCS: T10, T15, T20, T25, T27, T30, T40
1	ADAPTOR 25MM FROM 1/4" TO 1/4 SQR.
1	ADAPTOR MAGNET QUICK RELEASE



Art.No barcode
158901 3800123171680

SCREWDRIVER BITS & MAGNETIC HOLDER QUICK-CHANGE

[BG] Накрайници и магнитен държач бърз захват 1/4" 42 бр. к-т RAIDER • [RO] Set biti 42 buc • [SR] Pin Set 42 kom • [MK] Битови, Сет 42 пар • [RU] Набор бит 42 шт • [SL] Set bit-nastavkov 42-delni komplet • [EL] Σет μύτες 42 τεμαχίων σε κασετίνα • [HR] Set bitovi 1/4 "42 kom • [FR] Embouts de tournevis et support magnétique à changement rapide 1/4 "Set de 42 pièces • [IT] Set di cacciaviti e supporto magnetico Set rapido 1/4 "42 pezzi • [ES] Nozzles kaj magneta posedanto fastas 1/4 "42 komputilojn • [PT] Bicos e suporte magnético fixam 1/4 "42 peças

pcs	Sizing
36	25mm(L) BIT
	<ul style="list-style-type: none"> SLOTTED: 4 X 2PCS, 5, 6 PHILLIPS: PH1, PH2, PH3 X 3PCS POZI: PZ1, PZ2, PZ3 X 4PCS 3PCS HEX: 3, 4, 5 7PCS T10, T15, T20, T25, T27, T30, T40 7PCS: T10, T15, T20, T25, T27, T30, T40
4	75mm BIT: Sl: 6, PH2, Pozi: PZ2, Torx: T25
1	ADAPTOR 25MM FROM 1/4" TO 1/4 SQR.
1	ADAPTOR MAGNET QUICK RELEASE

1/4" 42 PCS. SET



Art.No barcode
158902 3800123171697

CLAMPING AND WORKING TAB

[BG] Маса работна-менгеме • [RO] Banc de lucru • [SR] Radni sto sklopivi • [MK] Маса работна
• [RU] Стол-верстак • [SL] Delovna miza • [EL] Πάγκος εργασίας • [HR] Stezni i radni stol • [FR]
Serrage et table de travail • [IT] Morsetto e tavolo di lavoro • [ES] Sujeción y mesa de trabajo. [PT]
Fixação e mesa de trabalho

FOLDABLE FOR EASY STORAGE



COLOR BOX

Art.No	barcode
139905	38001231119170

CLAMPING AND WORKING TAB

[BG] Маса работна-менгеме • [RO] Banc de lucru • [SR] Radni sto sklopivi • [MK] Маса работна
• [RU] Стол-верстак • [SL] Delovna miza • [EL] Πάγκος εργασίας • [HR] Stezni i radni stol • [FR]
Serrage et table de travail • [IT] Morsetto e tavolo di lavoro • [ES] Sujeción y mesa de trabajo. [PT]
Fixação e mesa de trabalho



COLOR BOX

Art.No	barcode
139970	3800123171758

DRILL STAND



- [BG] Стойка за бормашина
- [RO] Stativ pentru bormasina
- [SR] Postolje za bušilicu
- [MK] Држач за дупчалка
- [RU] Стенд для дрель
- [SL] Stojalo za vrtalnike
- [EL] Βάση Δραπάνου
- [HR] Stalac za bušilicu
- [FR] Support de foret
- [IT] Supporto per trapano
- [ES] Soporte para taladro
- [PT] Suporte para broca

Art.No	barcode
139201	3800972004054

ANGLE GRINDER STAND

[BG] Стойка за ъглошлайф • [RO] Stativ pentru polizor unghiular • [SR] Postolje za brusilica
ugaona • [MK] Држач за брусилка • [RU] Стенд для угловая шлифовальная машина • [SL]
Stojalo za kotni brusilnik • [EL] Βάση γωνιακος τροχος • [HR] Stalac za kutnu brusilicu • [FR]
Support pour meuleuse d'angle • [IT] Supporto per angle grinder • [ES] Soporte para amoladora
angular • [PT] Suporte para rebarbadora



COLOR BOX

**115
mm**

**125
mm**

Art.No	barcode
139912	3800123126208
139501	3800972004061

ANGLE GRINDER STAND

[BG] Стойка за ъглошлайф • [RO] Stativ pentru polizor unghiular • [SR] Postolje za brusilica
ugaona • [MK] Држач за брусилка • [RU] Стенд для угловая шлифовальная машина • [SL]
Stojalo za kotni brusilnik • [EL] Βάση γωνιακος τροχος • [HR] Stalac za kutnu brusilicu • [FR]
Support pour meuleuse d'angle • [IT] Supporto per angle grinder • [ES] Soporte para amoladora
angular • [PT] Suporte para rebarbadora



COLOR BOX

**230
mm**

Art.No	barcode
139913	3800123126215

DRILL STAND VICE DIE CAST BODY

• [BG] Менгеме машинно • [RO] Menghina pentru bormasina • [SR] Stega za stubnu bušilicu
• [MK] Менгеме за бормашина • [RU] Станочные поворотные тиски • [SL] Primež za namizni
vrtalni stroj • [EL] Μεγνηνη για την βαση • [HR] Stega za Stupna bušilica • [FR] Support pour
meuleuse d'angle • [IT] Morsa girevole della macchina • [ES] Soporte para amoladora angular
• [PT] Suporte para rebarbadora

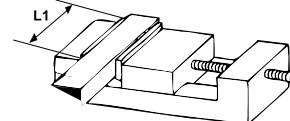

**L1
75mm**

**L1
100mm**

Art.No	barcode
139914	3800123119132
139915	3800123119149

ADAPTER SDS-PLUS TO CHUCK

[BG] Адаптер SDS-plus за патронник • [RO] Adaptor mandrina SDS-PLUS • [SR] Adapter SDS-plus • [MK] Адаптер SDS-plus за пречник • [RU] Переходник для патрона SDS-Plus • [SL] Adapter SDS-plus za vrtalna glava • [EL] Στελεχος υποδοχης sds plus για τσοκ • [HR] Adapter stezne glave • [FR] Adaptateur SDS-plus au mandrin • [IT] Adattatore SDS-plus a Chuck • [ES] Adaptador SDS-plus a Chuck • [PT] Adaptador SDS-plus para Chuck



Art.No barcode
159901 3800123125607

DRILL CHUCK KEYLESS 2 PLASTIC SLEEVE FOR RD-KC01

[BG] Патронник за бормашина самозатягащ пластм. • [RO] Mandrina rapida • [SR] Stezna glava plast. brzostežuca • [MK] Стезна глава [RU] Патрон дря дрели без ключа • [SL] Vrtalna glava samozatezna • [EL] Τσοκ δρασάνου αυτόματο • [HR] Brzostezna glava • [FR] Mandrin de perçage sans clé • [IT] Mandrino autoserrante • [ES] Boru bastonon • [PT] Mandril de brocas sem chave

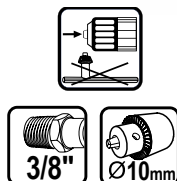

Art.No barcode
139906 3800123123931

DRILL CHUCK KEYLESS 2 PLASTIC SLEEVE FOR RD-KC01

[BG] Патронник за бормашина самозатягащ пластм. • [RO] Mandrina rapida • [SR] Stezna glava plast. brzostežuca • [MK] Стезна глава [RU] Патрон дря дрели без ключа • [SL] Vrtalna glava samozatezna • [EL] Τσοκ δρασάνου αυτόματο • [HR] Brzostezna glava • [FR] Mandrin de perçage sans clé • [IT] Mandrino autoserrante • [ES] Boru bastonon • [PT] Mandril de brocas sem chave
+ ADAPTER 1/4"

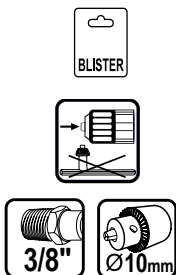

Art.No barcode
139003 3800123163814

DRILL CHUCK KEYLESS 2 PLASTIC SLEEVE FOR RD-KC01

[BG] Патронник за бормашина самозатягащ пластм. • [RO] Mandrina rapida • [SR] Stezna glava plast. brzostežuca • [MK] Стезна глава [RU] Патрон дря дрели без ключа • [SL] Vrtalna glava samozatezna • [EL] Τσοκ δρασάνου αυτόματο • [HR] Brzostezna glava • [FR] Mandrin de perçage sans clé • [IT] Mandrino autoserrante • [ES] Boru bastonon • [PT] Mandril de brocas sem chave

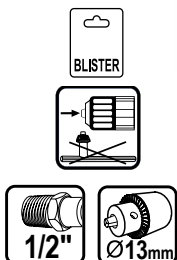

Art.No barcode
139908 3800123139488

DRILL CHUCK WITH KEY

[BG] Патронник за бормашина с ключ • [RO] Mandrina cu cheie • [SR] Stezna glava • [MK] Стезна глава со ключ • [RU] Патрон дря дрели с ключа • [SL] Vrtalna glava • [EL] Τσοκ δρασάνου με κλειδι • [HR] Stezna glava s ključem • [FR] Mandrin de perçage avec clé • [IT] Stesna Head con Kluch • [ES] Triluču Chuck kun Šlosilo • [PT] Capitulo Stesna com



art. No	for model	Ø (mm)	barcode
139001	RD-KC13	16	3800123162138
139002	RD-KC14	13	3800123162862
139907	RD-KC03	13	3800123126253

DRILL CHUCK WITH KEY

[BG] Патронник за бормашина с ключ • [RO] Mandrina cu cheie • [SR] Stezna glava • [MK] Стезна глава со ключ • [RU] Патрон дря дрели с ключа • [SL] Vrtalna glava • [EL] Τσοκ δρασάνου με κλειδι • [HR] Stezna glava s ključem • [FR] Mandrin de perçage avec clé • [IT] Stesna Head con Kluch • [ES] Triluču Chuck kun Šlosilo • [PT] Capitulo Stesna com

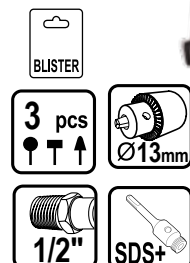

Art.No barcode
999902 3800123123627



DRILL CHUCK WITH KEY

[BG] Патронник за бормашина с ключ • [RO] Mandrina cu cheie • [SR] Stezna glava • [MK] Стезна глава со клуч • [RU] Патрон дря дрели без ключа • [SL] Vrtalna glava • [EL] Τσοκ дрπάτoυ με κλειδί • [HR] Stezna glava s klijučem • [FR] Mandrin de perçage avec clé • [IT] Stesna Head con Kluch • [ES] Triluču Chuck kun Šlosilo • [PT] Capitulo Stesna com

SLEEVE PLASTIC, REAR SLEEVE METAL



Art.No barcode
139943 3800123150203

METAL SLEEVE WITH CLICK FOR RD-KC11

[BG] Патронник за бормашина с ключ • [RO] Mandrina cu cheie • [SR] Stezna glava • [MK] Стезна глава со клуч • [RU] Патрон дря дрели без ключа • [SL] Vrtalna glava • [EL] Τσοκ дрπάτoυ με κλειδί • [HR] Stezna glava s klijučem • [FR] Mandrin de perçage avec clé • [IT] Stesna Head con Kluch • [ES] Triluču Chuck kun Šlosilo • [PT] Capitulo Stesna com



Art.No barcode
139942 3800123149870

DRILL CHUCK CONE WITH KEY

[BG] Патронник за бормашина с ключ • [RO] Mandrina cu cheie • [SR] Stezna glava • [MK] Стезна глава со клуч • [RU] Патрон дря дрели с ключа • [SL] Vrtalna glava • [EL] Τσοκ дрπάτoυ με κλειδί • [HR] Stezna glava s klijučem • [FR] Mandrin de perçage avec clé • [IT] Stesna Head con Kluch • [ES] Triluču Chuck kun Šlosilo • [PT] Capitulo Stesna com



art. №	for model	Ø (mm)	B	barcode
139921	RD-KC04	13	16	3800123124792
139922	RD-KC05	16	16	3800123124808
139925	RD-KC06	20	22	3800123124730



CHUCK KEY FOR DRILL CHUCK

[BG] Ключ за патронник на бормашина • [RO] Cheie mandrina • [SR] Klijuč za steznu glavu bušilice • [MK] Клуч за стезна глава • [RU] Ключ для патрона • [SL] Klijuč za vrtalna glava • [EL] Кλειδί για τσοκ • [HR] Klijuč za Stezna glava • [FR] Clé de mandrin pour mandrin • [IT] Chiave per mandrino • [ES] Llave de sujeción de tornillo • [PT] Chave de aperto de parafuso



art. №	for model	Ø (mm)	barcode
139903	RD-KC08	13	3800123126260
139004	RD-KC15	16	3800972014329



PAINT MIXER HEX

[BG] Бъркалка за боя • [RO] Mixer vopsea • [SR] Mešač • [MK] Мешалка за боја • [RU] Миксер для краски металлический • [SL] Barve mešalnikom • [EL] Αναδευτήρας χρωμάτων • [HR] Mješač • [FR] Mélangeur de peinture • [IT] Miscelatore di vernice • [ES] Mezclador de pintura • [PT] Misturador de tinta

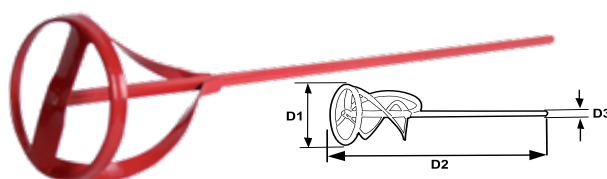

art. №	D1 (mm)	D2 (mm)	D3 (mm)	barcode
329901	Ø80	400	8 HEX	3800123126239
329902	Ø100	600	10 HEX	3800123126246



MIXING PADDLE

[BG] Бъркалка • [RO] Mixer vopsea • [SR] Mešač • [MK] Мешалка • [RU] Миксер металлический • [SL] Mešalnikom • [EL] Αναδευτήρας • [HR] Mješač • [FR] Mélangeur • [IT] Pagaia • [ES] Mezclador • [PT] Mixer

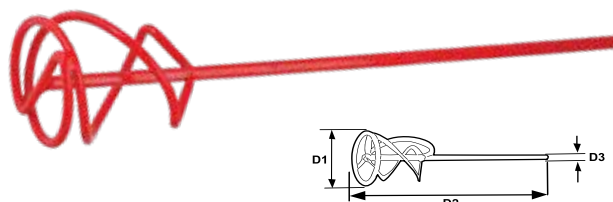

art. №	D1 (mm)	D2 (mm)	D3 (mm)	barcode
329925	Ø80	400	8 HEX	3800123127793
329926	Ø100	600	10 HEX	3800123127809



MIXING PADDLE WITH FLAT SPIRAL

[BG] Бъркалка • [RO] Mixer vopsea • [SR] Mešač • [MK] Мешалка • [RU] Миксер металлический • [SL] Mešalnikom • [EL] Αναδευτήρας • [HR] Mješač • [FR] Pagaie de mélange avec spirale plate [IT] Paletta di miscelazione con spirale piatta • [ES] Paleta Mezcladora • [PT] Misturando paddle

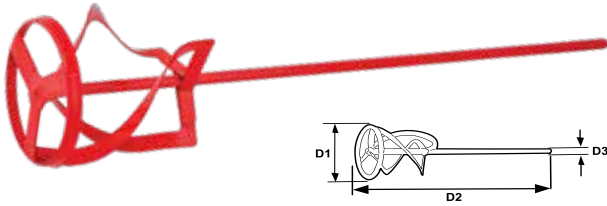

art. №	D1 (mm)	D2 (mm)	D3 (mm)	barcode
329927	Ø100	600	10 HEX	3800123127816
329928	Ø120	600	10 HEX	3800123127823



MIXING PADDLE SDS-PLUS

[BG] Бъркалка • [RO] Mixer vopsea • [SR] Mešač • [MK] Мешалка • [RU] Миксер металлический • [SL] Mešalnikom • [EL] Αναδευτήρας • [HR] Mješač • [FR] Pagaie de mélange avec spirale plate [IT] Paletta di miscelazione con spirale piatta • [ES] Paleta Mezcladora • [PT] Misturando paddle

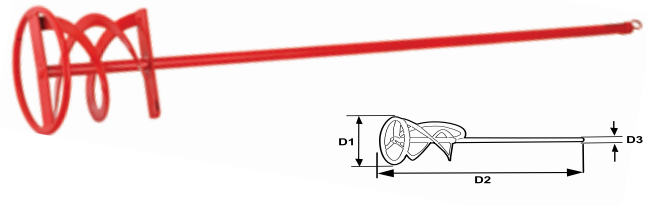

art. №	D1 (mm)	D2 (mm)	D3 (mm)	barcode
329935	Ø80	400	10 SDS+	3800123151224
329936	Ø100	600	10 SDS+	3800123151231



MIXING PADDLE FOR POWER MIXER

[BG] Бъркалка • [RO] Mixer vopsea • [SR] Mešač • [MK] Мешалка • [RU] Миксер металлический • [SL] Mešalnikom • [EL] Αναδευτήρας • [HR] Mješač • [FR] Pagaie de mélange avec spirale plate [IT] Paletta di miscelazione con spirale piatta • [ES] Paleta Mezcladora • [PT] Misturando paddle

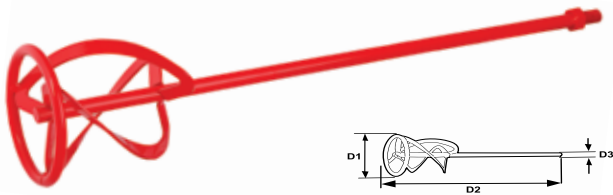

art. №	D1 (mm)	D2 (mm)	D3 (mm)	barcode
329924	Ø120	600	M14	3800123127786



MIXING PADDLE ZINC PLATED HEX

[BG] Бъркалка поцинкована за боя • [RO] Mixer zincat pentru vopsea • [SR] Mešač pocinkovan za boja • [MK] Мешалка поцинкувана за боја • [RU] Миксер металлический • [SL] Mešalnikom pocinkana • [EL] Αναδευτήρας γαλβανιζέ • [HR] Mješač pocinčane za boja • [FR] Mélangeur galvanisé pour peinture • [IT] Miscelatore zincato per vernice • [ES] Mezclador galvanizado para pintura • [PT] Mezclador galvanizado para pintura

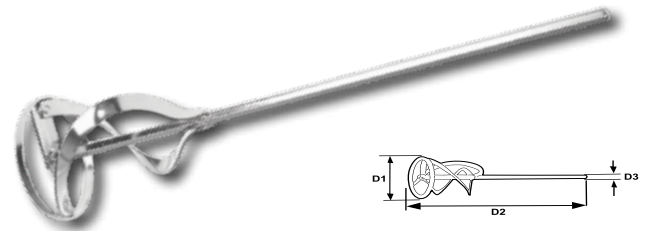

art. №	D1 (mm)	D2 (mm)	D3 (mm)	barcode
138501	Ø80	400	8 HEX	3800123166297
138502	Ø80	400	8 HEX	3800123166303
138503	Ø100	600	10 HEX	3800123166310



MIXING PADDLE SDS-PLUS ZINC PLATED

[BG] Бъркалка поцинкована за боя • [RO] Mixer zincat pentru vopsea • [SR] Mešač pocinkovan za boja • [MK] Мешалка поцинкувана за боја • [RU] Миксер металлический • [SL] Mešalnikom pocinkana • [EL] Αναδευτήρας γαλβανιζέ • [HR] Mješač pocinčane za boja • [FR] Mélangeur galvanisé pour peinture • [IT] Miscelatore zincato per vernice • [ES] Mezclador galvanizado para pintura • [PT] Mezclador galvanizado para pintura

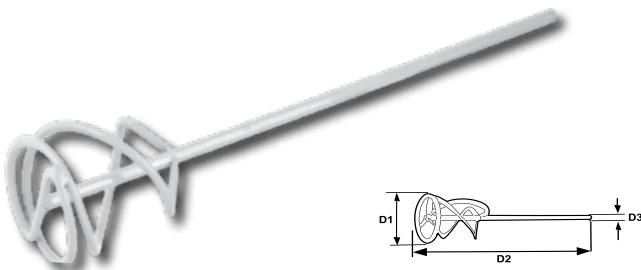

art. №	D1 (mm)	D2 (mm)	D3 (mm)	barcode
138504	Ø80	400	SDS+	3800123166327
138505	Ø100	600	SDS+	3800123166334

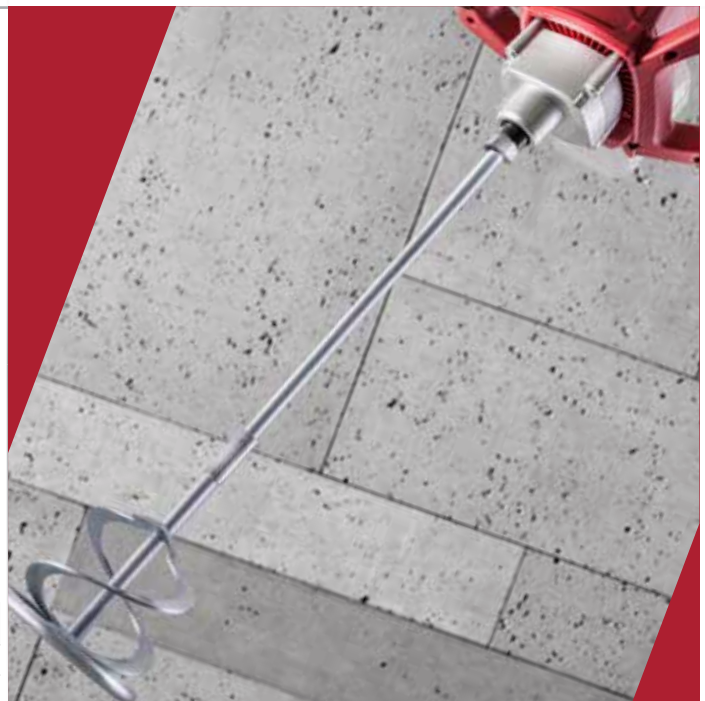

MIXING PADDLE FOR ELECTRIC POWER MIXER ZINC PLATED

[BG] Бъркалка поцинкована за електрически миксер • [RO] Mixer zincat • [SR] Mešač pocinkovan • [MK] Мешалка поцинкована • [RU] Миксер металлический • [SL] Mešalnikom pocinkana • [EL] Αναδευτήρας γαλβανιζέ • [HR] Mješač pocinčane • [FR] Mélangeur zingué électrique • [IT] Miscelatore zincato elettrico • [ES] Mezclador chapado en zinc eléctrica • [PT] Misturador zincado eléctrica

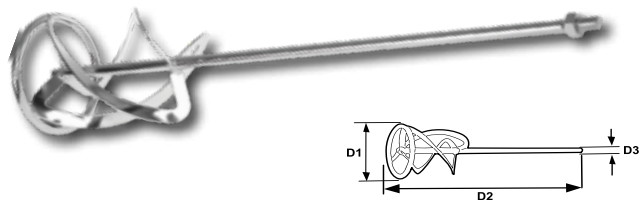

art. №	D1 (mm)	D2 (mm)	D3 (mm)	barcode
138506	Ø120	600	M14	3800123166341

MIXING PADDLE FOR ELECTRIC POWER MIXER WITH 2 PADDLES ZINC PLATED

[BG] Бъркалка поцинкована за електрически миксер • [RO] Mixer zincat • [SR] Mešač pocinkovan • [MK] Мешалка поцинкована • [RU] Миксер металлический • [SL] Mešalnikom pocinkana • [EL] Αναδευτήρας γαλβανιζέ • [HR] Mješač pocinčane • [FR] Mélangeur zingué électrique • [IT] Miscelatore zincato elettrico • [ES] Mezclador chapado en zinc eléctrica • [PT] Misturador zincado eléctrica

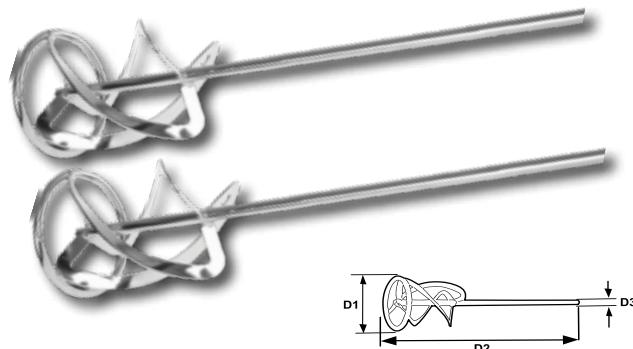

art. №	D1 (mm)	D2 (mm)	D3 (mm)	barcode
138507	Ø125	600	13 HEX	3800972012615

RUBBER BACKING DISK VELCRO UNIVERSAL

[BG] Диск VELCRO универсален • [RO] Suport din cauciuc disc VELCRO universal • [SR] Nosač Disk VELCRO univerzalan • [MK] Гумена диск VELCRO универзална • [RU] Резиновый диск VELCRO универсальный • [SL] Gumijasta podlogka disk VELCRO • [EL] Υποστηρικτικός δίσκος από καουτσούκ δίσκο VELCRO Παγκόσμιος • [HR] Gumena podloga Disk VELCRO univerzalana • [FR] Disque support en caoutchouc VELCRO universel • [IT] Supporto in gomma Disco VELCRO universale • [ES] Καύθα apogilo Disko VELCRO universala • [PT] Disco protetor de borracha VELCRO universal

VELCRO



art. №	W (mm)	barcode
139971	Ø115	3800972002241
139972	Ø125	3800972002258

RUBBER BACKING DISK FOR ANGLE GRINDER

[BG] Диск гумен за ъглошлайф • [RO] Suport circular cauciuc • [SR] Nosač brusnog papira gumeni • [MK] Гумен диск за абразивна хартија за брусилка • [RU] Резиновый диск для угловая шлифовальная машина • [SL] Podložak fiber gumena za kotni brusilnik • [EL] Μαξιλάρι δραστικού λαστιχένιο • [HR] Gumena ploča za Kutna brusilica • [FR] Caoutchouc à disque pour meuleuse d'angle • [IT] Disco in gomma per smerigliatrice angolare • [ES] Disco de goma para amoladora angular • [PT] Borracha de disco para rebarbadora

Ø 180mm

FOR ANGLE GRINDER

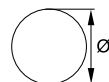

Art.No	barcode
139920	3800123135781

RUBBER BACKING DISK VELCRO FOR ANGLE GRINDER

Ø 180mm

FOR ANGLE GRINDER

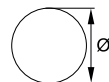

VELCRO

Art.No	barcode
139924	3800123126062

LAMBSWOOL POLISHING BONNET FOR POLISHER

[BG] Кече за полирмашина • [RO] Rezerva polizat • [SR] Navlaka za poliranje jagnjeće vune • [MK] Волнен пад за полирка • [RU] Круг полировальный (натуральная овчина) на липучке • [SL] Krzno za poliranje spužvasto • [EL] Μάλλινος σκούφος για στιλβωτές • [HR] Vuneni jastučić • [FR] Bonnet de polissage en laine d'agneau pour polisseuse • [IT] Cappellino per lucidatura Lambswool per lucidatrice • [ES] Lambswool poluranta tuneton por polisher • [PT] Boné de polimento de lã de cordeiro para polidor



art. №	Ø (mm)	barcode
209934	125	3800123150692
209935	180	3800123150708
209914	240	3800123107313

POLISHING SPONGE

[BG] Гъба за полиране • [RO] Buretele de lustruit • [SR] Spužva za poliranje • [MK] Полирање сунѓер • [RU] Полировка губки • [SL] Gobica za poliranje • [EL] Σφουγγάρι στιλβωσης • [HR] Spužva za poliranje • [FR] Éponge à polir • [IT] Spugna per lucidare • [ES] Polura spongo • [PT] Esponja de polimento



Art.No	barcode
155801	3800972016620

POLISHING KIT DISC VELCRO, LAMBSWOOL POLISHING BONNET, SPONGE

[BG] К-т за пастиране блокче, кече, гъба • [RO] 3Pcs/s Set polisare • [SR] Set za poliranje 3 kom • [MK] Set за полирање 3 броејот • [RU] Набор насадок для полировки 3 шт. • [SL] 3-delni komplet za poliranje • [EL] Σετ στίλβωσης 3 τεμ • [HR] Vuneni jastučić, Spužvasti jastučić, Brusni disk • [FR] Kit de polissage disque, Bonnet de polissage en laine d'agneau, Eponge • [IT] Disco per lucidatura V, cuffia per lucidatura in lana d'agnello, spugna • [ES] Poluranta kitran diskon, Lambswool Poluranta Bonneton, Spongon • [PT] Kit de polimento disc, boné de polimento lambswool, esponja



Art.No barcode
499976 3800123150715

FLAT TAPERED SCYTHE STONE GREY

[BG] Брус овален сив • [RO] Piara pentru ascutit coasa • [SR] Kamen za oštrenje • [MK] Камен за острене на коса • [RU] Точильный камень • [SL] Brus za oštrenje • [EL] Πέτρα Ακονίσματος • [HR] Brusni kamen • [FR] Scythe plate, gris pierre • [IT] Pietra squadrata affusolata grigia • [ES] Ebena Blanka Štono • [PT] Cinza de pedra afilado liso da foice



COLOR BOX



Art.No barcode
499961 3800123136412

COMBINATION SHAPE STONE WHITE & GREY

[BG] Брус комбиниран бяло и сиво • [RO] Piatra dreptunghiulara pentru ascutit cutite • [SR] Kamen za oštrenje kompozitni • [MK] Брусен камен комбиниран • [RU] Точильный камень составной • [SL] Brus za oštrenje kompozitni • [EL] Πέτρα ακονίσματος σύνθετος • [HR] Brusni kamen • [FR] Combinaison forme pierre blanche et grise • [IT] Combinazione di forma pietra bianca e grigia • [ES] Kombina formo štono blanka kaj griza • [PT] Combinação em forma de pedra branca e cinza

200x50x25mm



COLOR BOX

H 25mm
L2 200mm
L1 50mm

Art.No barcode
499958 3800123136382

COMBINATION SHAPE STONE PINK & GREY

[BG] Брус комбиниран розово и сиво • [RO] Piatra dreptunghiulara pentru ascutit cutite • [SR] Kamen za oštrenje kompozitni • [MK] Брусен камен комбиниран • [RU] Точильный камень составной • [SL] Brus za oštrenje kompozitni • [EL] Πέτρα ακονίσματος σύνθετος • [HR] Brusni kamen • [FR] Combinaison forme pierre rose & gris • [IT] Combinazione shape stone pink & grey • [ES] Kombina shape stone rozkolora & griza • [PT] Combinação forma pedra rosa e cinza

200x50x25mm



COLOR BOX

H 25mm
L2 200mm
L1 50mm

Art.No barcode
499959 3800123136399

HAND SANDER

[BG] Шлайф ръчен • [RO] Suport smirghel • [SR] Nosač brusnog papira • [MK] Држач за шмиргла • [RU] Блок для ручного шлифования • [SL] Ročno brusilni blok • [EL] Μπλοκ για λείανσης • [HR] Ručna brusilica • [FR] Ponçeuse à main • [IT] Mano levigatrice • [ES] Muellilo manlibro • [PT] Manual do moedor



art. №	D1 (mm)	D2 (mm)	BARCODE
499986	85	160	3800123157059
499902	100	210	3800123135095

HAND SANDER WITH HANDLE



Art.No barcode
499901 3800123135101

TRIMMER LINE FOR GRASS TRIMMER ROUND

[BG] Корда за косачка тример • [RO] Fir rezerva trimmer • [SR] Najlon za trimer • [MK] Конец за косилка • [RU] Леска для триммера • [SL] Najlonska nitka za obrezovalnik trave • [EL] Μεσινέζα στρουγγυλή • [HR] Najlonska nit Okrugla • [FR] Ligne de coupe pour coupe-herbe ronde • [IT] Trimmer per tosaerba rotondo • [ES] Trimmer-linio por herba trimmer • [PT] Aparador para aparador de grama

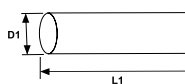

art. №	D1 (mm)	L1 (m)	barcode
110208	1.3	15	3800123151811
110210	1.65	15	3800123151859
110204	2.40	15	3800123141706

TRIMMER LINE FOR BRUSH CUTTERS ROUND

[BG] Корда за косачка тример • [RO] Fir rezerva trimmer • [SR] Najlon za trimer • [MK] Конец за косилка • [RU] Леска для триммера • [SL] Najlonska nitka za obrezovalnik trave • [EL] Μεσινεζα στρογγυλη • [HR] Najlonska nit Okrugla • [FR] Ligne de coupe pour coupe-herbe ronde • [IT] Trimmer per tosaerba rotondo • [ES] Trimmer-linio por herba trimmer • [PT] Aparador para aparador de grama

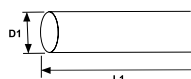

art. №	D1 (mm)	L1 (m)	barcode
110227	3.0	15	3800123166372

TRIMMER LINE FOR GRASS TRIMMER SQUARE

[BG] Корда за косачка тример • [RO] Fir rezerva trimmer • [SR] Najlon za trimer • [MK] Конец за косилка • [RU] Леска для триммера • [SL] Najlonska nitka za obrezovalnik trave • [EL] Μεσινεζα στρογγυλη • [HR] Najlonska nit Okrugla • [FR] Ligne de coupe pour coupe-herbe ronde • [IT] Trimmer per tosaerba rotondo • [ES] Trimmer-linio por herba trimmer • [PT] Aparador para aparador de grama

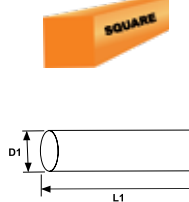

art. №	D1 (mm)	L1 (m)	barcode
110209	1.3	15	3800123151828
110211	1.65	15	3800123151835
110212	2.40	15	3800123151842

TRIMMER LINE SQUARE

[BG] Корда за косачка тример • [RO] Fir rezerva trimmer • [SR] Najlon za trimer • [MK] Конец за косилка • [RU] Леска для триммера • [SL] Najlonska nitka za obrezovalnik trave • [EL] Μεσινεζα στρογγυλη • [HR] Najlonska nit Okrugla • [FR] Ligne de coupe pour coupe-herbe ronde • [IT] Trimmer per tosaerba rotondo • [ES] Trimmer-linio por herba trimmer • [PT] Aparador para aparador de grama

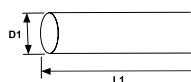

art. №	D1 (mm)	L1 (m)	barcode
110226	3.0	15	3800123166365

FORCE STRING TRIMMER LINE FOR BRUSH CUTTERS SQUARE

[BG] Корда за косачка тример • [RO] Fir rezerva trimmer • [SR] Najlon za trimer • [MK] Конец за косилка • [RU] Леска для триммера • [SL] Najlonska nitka za obrezovalnik trave • [EL] Μεσινεζα στρογγυλη • [HR] Najlonska nit Okrugla • [FR] Ligne de coupe pour coupe-herbe ronde • [IT] Trimmer per tosaerba rotondo • [ES] Trimmer-linio por herba trimmer • [PT] Aparador para aparador de grama

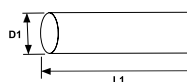

art. №	D1 (mm)	L1 (m)	barcode
110280	1.65	15	3800972003880
110281	2.00	15	3800972003897

FORCE STRING TRIMMER LINE FOR BRUSH CUTTERS SQUARE

[BG] Корда за косачка тример • [RO] Fir rezerva trimmer • [SR] Najlon za trimer • [MK] Конец за косилка • [RU] Леска для триммера • [SL] Najlonska nitka za obrezovalnik trave • [EL] Μεσινεζα στρογγυλη • [HR] Najlonska nit Okrugla • [FR] Ligne de coupe pour coupe-herbe ronde • [IT] Trimmer per tosaerba rotondo • [ES] Trimmer-linio por herba trimmer • [PT] Aparador para aparador de grama

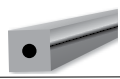
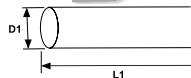

art. №	D1 (mm)	L1 (m)	barcode
110235	2.4	15	3800123167409

FORCE STRING TRIMMER LINE FOR BRUSH CUTTERS SQUARE

[BG] Корда за косачка тример • [RO] Fir rezerva trimmer • [SR] Najlon za trimer • [MK] Конец за косилка • [RU] Леска для триммера • [SL] Najlonska nitka za obrezovalnik trave • [EL] Μεσινεζα στρογγυλη • [HR] Najlonska nit Okrugla • [FR] Ligne de coupe pour coupe-herbe ronde • [IT] Trimmer per tosaerba rotondo • [ES] Trimmer-linio por herba trimmer • [PT] Aparador para aparador de grama

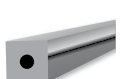
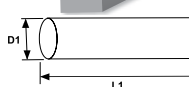

art. №	D1 (mm)	L1 (m)	barcode
110282	3.0	12	3800972003903
110283	3.5	8	3800972003910
110285	4.0	6	3800972004269
110286	4.5	5	3800972004276

FORCE STRING TRIMMER LINE FOR BRUSH CUTTERS SQUARE

PLATIN SILVER

[BG] Корда за косачка тример • [RO] Fir rezerva trimmer • [SR] Najlon za trimer • [MK] Конец за косилка • [RU] Леска для триммера • [SL] Najlonska nitka za obrezovalnik trave • [EL] Μεσινεζα στρουγγυλη • [HR] Najlonska nit Okrugla • [FR] Ligne de coupe pour coupe-herbe ronde • [IT] Trimmer per tosaerba rotondo • [ES] Trimmer-linio por herba trimmer • [PT] Aparador para aparador de grama

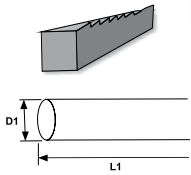

art. №	D1 (mm)	L1 (m)	barcode
110290	2.7	15	3800972015807
110291	3.0	12	3800972015814

TRIMMER LINE FOR GRASS TRIMMER TWISTED

[BG] Корда за косачка тример • [RO] Fir rezerva trimmer • [SR] Najlon za trimer • [MK] Конец за косилка • [RU] Леска для триммера • [SL] Najlonska nitka za obrezovalnik trave • [EL] Μεσινεζα στρουγγυλη • [HR] Najlonska nit Okrugla • [FR] Ligne de coupe pour coupe-herbe ronde • [IT] Trimmer per tosaerba rotondo • [ES] Trimmer-linio por herba trimmer • [PT] Aparador para aparador de grama

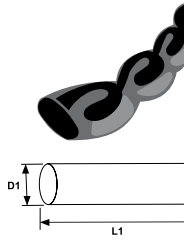

art. №	D1 (mm)	L1 (m)	barcode
110248	3.0	28	3800123172090
110249	3.3	46	3800123172106
110250	4.0	32	3800123172113
110251	4.5	25	3800123172120

FORCE STRING TRIMMER LINE FOR BRUSH CUTTERS ROUND

[BG] Корда за косачка тример • [RO] Fir rezerva trimmer • [SR] Najlon za trimer • [MK] Конец за косилка • [RU] Леска для триммера • [SL] Najlonska nitka za obrezovalnik trave • [EL] Μεσινεζα στρουγγυλη • [HR] Najlonska nit Okrugla • [FR] Ligne de coupe pour coupe-herbe ronde • [IT] Trimmer per tosaerba rotondo • [ES] Trimmer-linio por herba trimmer • [PT] Aparador para aparador de grama



art. №	D1 (mm)	L1 (m)	barcode
110236	2.4	260	3800123167416

TRIMMER HEAD FOR BRUSH CUTTERS

[BG] Корда с тримерна глава за коса • [RO] Mosor cu fir pentru motocositoare • [SR] Najlon za trimer • [MK] Конец за косилка • [RU] Леска для триммера • [SL] Najlonska nitka za obrezovalnik trave • [EL] Κεφαλή μεσινεζας • [HR] Najlonska rezna glava s dvije niti • [FR] Le cordon avec une tête de cheveux en trois dimensions • [IT] La corda con una testa di capelli tridimensionale • [ES] La sñuro kun tridimensia hararo • [PT] O cabo com uma cabeça de cabelo tridimensional

M10x1.25LH

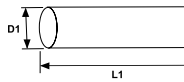

art. №	D1 (mm)	L1 (m)	barcode
110207	2.4	3	3800123143526

UNIVERSAL ALUMINIUM TRIMMER HEAD FOR BRUSH CUTTERS

[BG] Корда с тримерна глава за коса • [RO] Mosor cu fir pentru motocositoare • [SR] Najlon za trimer • [MK] Конец за косилка • [RU] Леска для триммера • [SL] Najlonska nitka za obrezovalnik trave • [EL] Κεφαλή μεσινεζας • [HR] Najlonska rezna glava s dvije niti • [FR] Le cordon avec une tête de cheveux en trois dimensions • [IT] La corda con una testa di capelli tridimensionale • [ES] La sñuro kun tridimensia hararo • [PT] O cabo com uma cabeça de cabelo tridimensional



Art.No	barcode
110262	3800123174667

UNIVERSAL TRIMMER HEAD FOR BRUSH CUTTERS

[BG] Корда с тримерна глава за коса • [RO] Mosor cu fir pentru motocositoare • [SR] Najlon za trimer • [MK] Конец за косилка • [RU] Леска для триммера • [SL] Najlonska nitka za obrezovalnik trave • [EL] Κεφαλή μεσινεζας • [HR] Najlonska rezna glava s dvije niti • [FR] Le cordon avec une tête de cheveux en trois dimensions • [IT] La corda con una testa di capelli tridimensionale • [ES] La sñuro kun tridimensia hararo • [PT] O cabo com uma cabeça de cabelo tridimensional

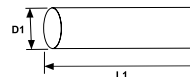

art. №	D1 (mm)	L1 (m)	barcode
110228	2.4	2.5	3800123166389

EASY LOAD TAP&GO TRIMMER HEAD FOR BRUSH CUTTERS

[BG] Корда с тримерна глава за коса • [RO] Mosor cu fir pentru motocosoitoare • [SR] Najlon za trimer • [MK] Конец за косилка • [RU] Леска для триммера • [SL] Najlonska nitka za obrezovalnik trave • [EL] Κεφαλή μεσινέζας • [HR] Najlonska rezna glava s dvije niti • [FR] Le cordon avec une tête de cheveux en trois dimensions • [IT] La corda con una testa di capelli tridimensionale • [ES] La šnuro kun tridimensia hararo • [PT] O cabo com uma cabeça de cabelo tridimensional



BLADE FOR GASOLINE BRUSH CUTTERS 3 TEETH

[BG] Нож за моторна коса три лъча • [RO] Cutit cu trei lame pentru motocosoitoare • [SR] Sečivo za trimer 3 kraka • [MK] Нож за бензински тример • [RU] Нож для бензиновый триммер - газонокосилка • [SL] Nož za travo za motorna kosa • [EL] Ανταλλακτικός δίσκος 3 δοντιων • [HR] Oštrica • [FR] Lame pour débroussaillouses à essence 3 dents • [IT] Lama per decespugliatori a benzina 3 denti • [ES] Blade por Gasoline Brush Cutters 3 Dento • [PT] Lâmina para cortadores de escova de gasolina 3 dentes

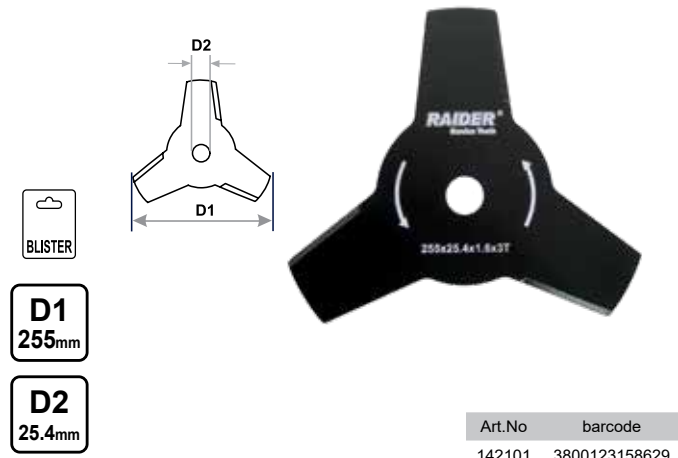

BLADE FOR GASOLINE BRUSH CUTTERS 4 TEETH

[BG] Нож за моторна коса четири лъча • [RO] Cutit cu trei lame pentru motocosoitoare • [SR] Sečivo za trimer 4 kraka • [MK] Нож за бензински тример • [RU] Нож для бензиновый триммер - газонокосилка • [SL] Nož za travo za motorna kosa • [EL] Ανταλλακτικός δίσκος 4 δοντιων • [HR] Oštrica 4 zuba • [FR] Couteau de moto à quatre rayons • [IT] Coltello da moto a quattro raggi • [ES] Trançilo de kvar-raketaj motorbikloj • [PT] Faca de moto de quatro feixes

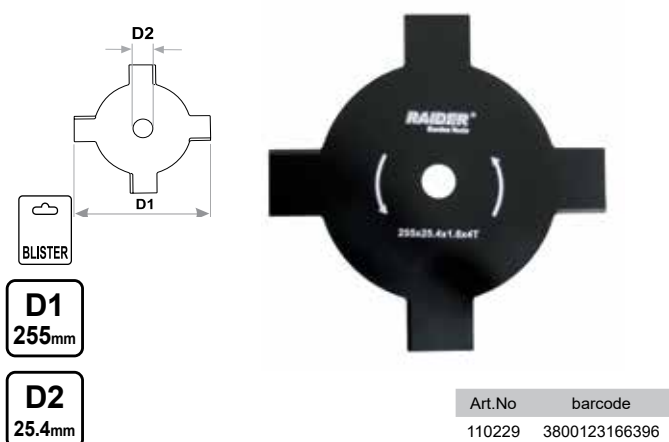

BLADE FOR GASOLINE BRUSH CUTTERS 40 TEETH

[BG] Диск за моторна коса TCT • [RO] Disc pentru motocosoitoare • [SR] List testere za trimer • [MK] Кружна пила за бензински тример • [RU] Циркулярный диск для бензиновый триммер - газонокосилка • [SL] Nož za motorna kosa • [EL] Δίσκοπρίονα • [HR] Listova pila • [FR] Lame pour débroussaillouses à essence 40 dents • [IT] Lama per decespugliatori a benzina 40 denti • [ES] Klingo por Gasoline Brush Cutters • [PT] Lâmina para cortadores de escova a gasolina

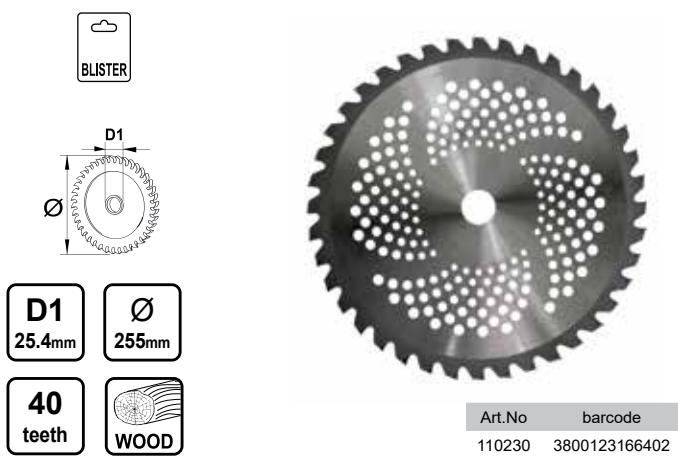

BLADE FOR BRUSH CUTTER 80 TEETH Ø255X25.4 MM

[BG] Диск за моторна коса TCT • [RO] Disc pentru motocosoitoare • [SR] List testere za trimer • [MK] Кружна пила за бензински тример • [RU] Циркулярный диск для бензиновый триммер - газонокосилка • [SL] Nož za motorna kosa • [EL] Δίσκοπρίονα • [HR] Listova pila • [FR] Lame pour débroussaillouses à essence 40 dents • [IT] Lama per decespugliatori a benzina 40 denti • [ES] Klingo por Gasoline Brush Cutters • [PT] Lâmina para cortadores de escova a gasolina

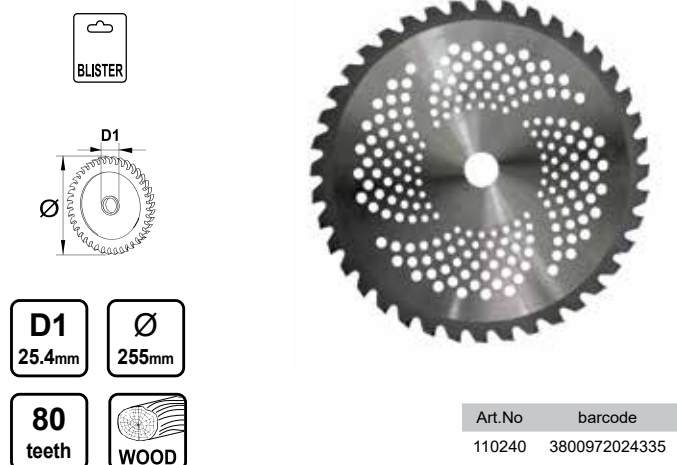

TWIST KNOT WIRE BEVEL BRUSH FOR BRUSH CUTTER

[BG] Четка телена за коса конусна плетена • [RO] Twist Knot Wire Bevel Perie pentru tăietorul de perii • [SR] Twist Knot Wire Bevel četka za sekač četkica • [MK] Twist Knot Wire Bevel Четка за четкање • [RU] Коническая щетка Twist Knot Wire для кусторезов • [SL] Twist Knot Wire Bevel Brush za rezalnik grmičevja • [EL] Twist Knot Wire Bevel Brush για θαμνοκοπτικό • [HR] Twist Knot Wire Bevel Brush za šikare • [FR] Twist Knot Wire Bevel Brush pour débroussaillouse • [IT] Spazzola smussata in filo intrecciato per decespugliatore • [ES] Cepillo biselado de alambre con nudo torcido para desbrozadora • [PT] Escova chanfrada de fio de nó de torção para cortador de escova



HARNESS FOR BRUSH CUTTERS

[BG] Самар за моторна коса универсален • [RO] Ham reglabil ptr motocoasa • [SR] Remen za pošenje • [MK] Раница за бензински тример • [RU] Ременная оснастка • [SL] Standarden oprtnik • [EL] Εξάρτησι • [HR] Univerzalne naramenice • [FR] Harnais pour débroussaillieuses • [IT] Imbracatura per decespugliatori [ES] Samar por motoro haro universal • [PT] Chicote de fios para cortadores de escova



Art.No barcode
110231 3800123166419

HARNESS WITH SHOULDER STRAPS

[BG] Самар за моторна коса с широки и меки колани универсален червен • [RO] Harnați cu curelele de umăr padding moale pentru tăietoare perie roșu • [SR] Žarenje sa ramenim kaiševima mekano podlogu za sečenje četkica crveno • [MK] Потпирач со ремени со рамно лежиште за црвени четкички • [RU] Жгут с погонами мягкой подкладки для кусторезов красный • [SL] Zarpiralo z ramenskimi pasovi mehka obloga za rezila za krtače rdeča • [EL] Απολαύστε με ιμάντες ώμου μαλακή επένδυση για κόπτες βούρτσας κόκκινο • [HR] Kabel s trakama za ramena meki padding za crvene četkice • [FR] Samar pour les cheveux moteur avec ceintures larges et douces universels rouge • [IT] Samar per capelli motore con cinghie larghe e morbide universali rosse • [ES] Samar por motoro haroj kun larġaj kaj molaj zonoj universalaj ruġaj • [PT] Samar para cabelos com cintos largos e macios vermelho universal



Art.No barcode
110284 3800972003927



HARNESS WITH SHOULDER STRAPS & SOFT PADDING FOR BRUSH CUTTERS

[BG] Самар за моторна коса с широки и меки колани универсален • [RO] Ham reglabil ptr motocoasa • [SR] Remen za pošenje • [MK] Раница за бензински тример • [RU] Ременная оснастка • [SL] Standarden oprtnik • [EL] Εξάρτησι • [HR] Univerzalne naramenice • [FR] Samar pour les cheveux moteur avec ceintures larges et douces universels • [IT] Samar per capelli motore con cinghie larghe e morbide universali • [ES] Samar por motoro haroj kun larġaj kaj molaj zonoj universalaj • [PT] Samar para cabelos com cintos largos e macios universal



Art.No barcode
110263 3800123174674

PETROL AND OIL HAND SUCTION PUMP 1.6L 1.3M HOSE RD

[BG] Помпа ръчна за масло и гориво • [RO] Pompă manuală de aspirație pentru benzină și ulei • [SR] Ručna usisna pumpa za benzin i ulje • [MK] Рачна пумпа за вшмукување бензин и масло • [RU] Ручной всасывающий насос для бензина и масла • [SL] Ročna sesalna črpalka za bencin in olje • [EL] Χειροκίνητη αντλία αναρρόφησης βενζίνης και λαδιού • [HR] Ručna pumpa za usisavanje benzina i ulja • [FR] Pompe d'aspiration à main pour essence et huile • [IT] Pompa di aspirazione manuale benzina e olio • [ES] Bomba de succión manual de gasolina y aceite • [PT] Bomba de sucção manual de gasolina e óleo



Art.No barcode
075907 3800972024618

ENGINE OIL SAE30 1L

[BG] Масло SAE30 1L • [RO] Ulei de motor SAE 30 1L • [SR] Motorno ulje SAE 30 1L • [MK] Моторно масло SAE 30 1L • [RU] Моторное масло SAE 30 1л • [SL] Motorno olje SAE 30 1L • [EL] Λάδι κινητήρα SAE 30 1L • [HR] Motorno ulje SAE 30 1L • [FR] Huile moteur SAE 30 1L • [IT] Olio motore SAE 30 1L • [ES] Engine Oil SAE 30 1L • [PT] Óleo de Motor SAE 30 1L



Two Stroke Oil 2T MIX
Масло за двутактови
двигатели 2T MIX
1000 ml

Art.No barcode
075903 3800123172076

ENGINE OIL SAE30 1L

[BG] Масло SAE30 1L • [RO] Ulei de motor SAE 30 1L • [SR] Motorno ulje SAE 30 1L • [MK] Моторно масло SAE 30 1L • [RU] Моторное масло SAE 30 1л • [SL] Motorno olje SAE 30 1L • [EL] Λάδι κινητήρα SAE 30 1L • [HR] Motorno ulje SAE 30 1L • [FR] Huile moteur SAE 30 1L • [IT] Olio motore SAE 30 1L • [ES] Engine Oil SAE 30 1L • [PT] Óleo de Motor SAE 30 1L



Art.No barcode
075906 3800972005105

GEAR OIL EP90 1L

[BG] Масло трансмисионно EP90 1L • [RO] Ulei de transmisie EP 90 1L • [SR] Prenosno ulje EP 90 1L • [MK]Преносно масло EP 90 1L • [RU] Трансмисионное масло EP 90 1L • [SL] Prenosno olje EP 90 1L • [EL] Λάδι κιβωτίου ταχυτήτων EP 90 1L • [HR] Ulje mjenjača EP 90 1L • [FR] Huile de transmission EP 90 1L • [IT] Olio cambio EP 90 1L • [ES] Transdono petrolo EP 90 1L • [PT] Óleo de Transmissão EP 90 1L



Art.No	barcode
075902	3800123172069

TWO STROKE SEMI SYNTHETIC LOW STROKE OIL 1L

[BG] Масло за двуктакви двигатели полусинтетично бездимно • [RO] Ulei de transmisie • [SR] Prenosno ulje • [MK]Преносно масло • [RU] Трансмисионное масло • [SL] Prenosno olje • [EL] Λάδι κιβωτίου ταχυτήτων • [HR] Ulje mjenjača • [FR] Huile de transmission • [IT] Olio cambio • [ES] Transdono petrolo • [PT] Óleo de Transmissão



Art.No	barcode
075905	3800972002487

euromaster



070044155



info@euromasterbg.com



www.raider.bg

Art. № 108028



Euromaster Import-Export Ltd
Bulgaria
1231 Sofia
246, "Lomsko shaussee" blvd
www.raider.bg
www.euromasterbg.com

